

ALLEN & HEATH



XONE:23

USER GUIDE

Publication AP9250_4

Limited One Year Manufacturer's Warranty

Allen & Heath warrants the Allen & Heath - branded hardware product and accessories contained in the original packaging ("**Allen & Heath Product**") against defects in materials and workmanship when used in accordance with Allen & Heath's user manuals, technical specifications and other Allen & Heath product published guidelines for a period of ONE (1) YEAR from the date of original purchase by the end-user purchaser ("**Warranty Period**").

This warranty does not apply to any non-Allen & Heath branded hardware products or any software, even if packaged or sold with Allen & Heath hardware.

Please refer to the licensing agreement accompanying the software for details of your rights with respect to the use of software ("EULA").

Details of the EULA, warranty policy and other useful information can be found on the Allen & Heath website: www.allen-heath.com/legal

Repair or replacement under the terms of the warranty does not provide right to extension or renewal of the warranty period. Repair or direct replacement of the product under the terms of this warranty may be fulfilled with functionally equivalent service exchange units.

This warranty is not transferable. This warranty does not cover fader wear and tear.

This warranty will be the purchaser's sole and exclusive remedy and neither Allen & Heath nor its approved service centres shall be liable for any incidental or consequential damages or breach of any express or implied warranty of this product.

Conditions of Warranty

The equipment has not been subject to misuse either intended or accidental, neglect, or alteration other than as described in the User Guide or Service Manual, or approved by Allen & Heath.

Any necessary adjustment, alteration or repair has been carried out by an authorised Allen & Heath distributor or agent.

The defective unit is to be returned carriage prepaid to the place of purchase, an authorised Allen & Heath distributor or agent with proof of purchase. Please discuss this with the distributor or the agent before shipping. If the unit is to be repaired in a different country to that of its purchase the repair may take longer than normal, whilst the warranty is confirmed and parts are sourced. Units returned should be packed in the original carton to avoid transit damage.

In certain territories the terms may vary. Check with your Allen & Heath distributor or agent for any additional warranty information which may apply.

If further assistance is required please contact Allen & Heath Ltd.

DISCLAIMER: Allen & Heath shall not be liable for the loss of any saved/stored data in products that are either repaired or replaced.



XONE:23 complies with the European Electromagnetic Compatibility directives 2014/30/EU and the European Low Voltage directives 2014/35/EU.

Any changes or modifications to the equipment not approved by Allen & Heath could void the compliance of the product and therefore the users authority to operate it.

XONE:23 User Guide AP9250 Issue 4

Copyright © 2018 Allen & Heath Limited. All rights reserved

Allen & Heath Limited

Kernick Industrial Estate, Penryn, Cornwall, TR10 9LU, UK

www.allen-heath.com

PACKED ITEMS

Check that you have received the following:

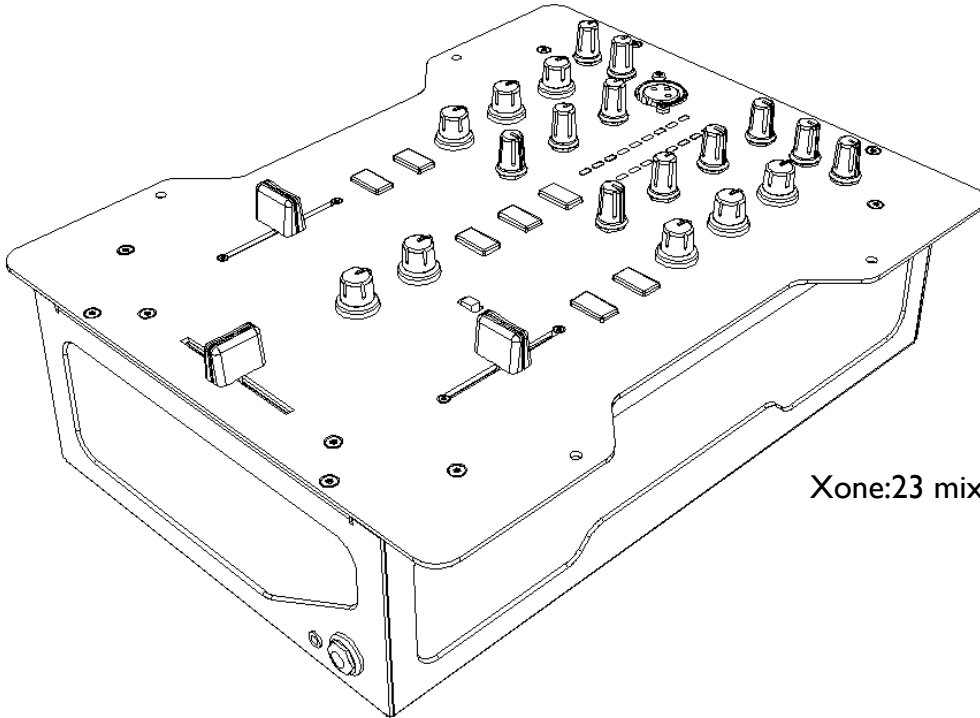

Xone:23 mixer

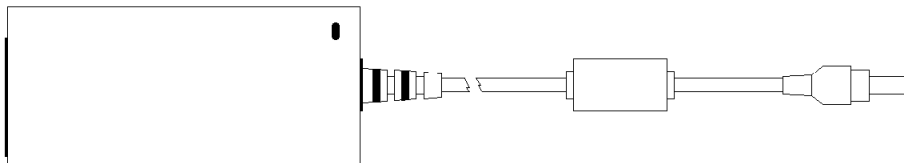

Power Supply
12V - 2.5 Amps

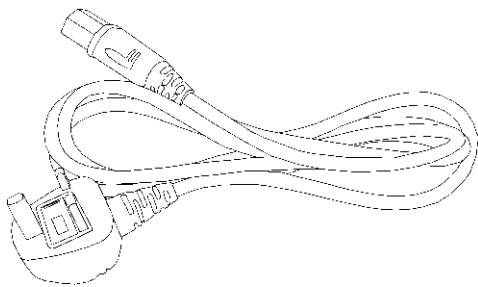

Power supply IEC Lead
This is country specific and will vary with mains voltage/territory

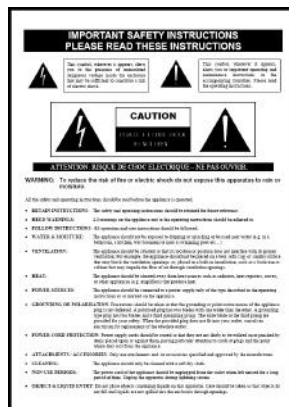

Safety Sheet
Important ! Read this sheet before starting.
Retain for future reference.

CONTENTS

Congratulations on purchasing the Allen & Heath Xone:23 performance DJ mixer. To ensure that you get the maximum benefit from the unit please spare a few minutes familiarizing yourself with the controls and setup procedures outlined in this user guide. For further information please refer to the additional information available on our web site, or contact our product support team.

<http://www.allen-heath.com>

Warranty	2
Packed Items.....	3
Contents.....	4
Connection diagram.....	5
Introduction.....	6
Input channel controls.....	7
Master section controls	8
Mic and Filter controls	9
Rear panel connections.....	10
Filters reference.....	11
Operating levels.....	12
Earthing.....	13
Servicing	14
User replaceable spare parts.....	15
Fault finding.....	16
Specification.....	17
Block Diagram.....	18
Product registration.....	20

APPLICATION DIAGRAM

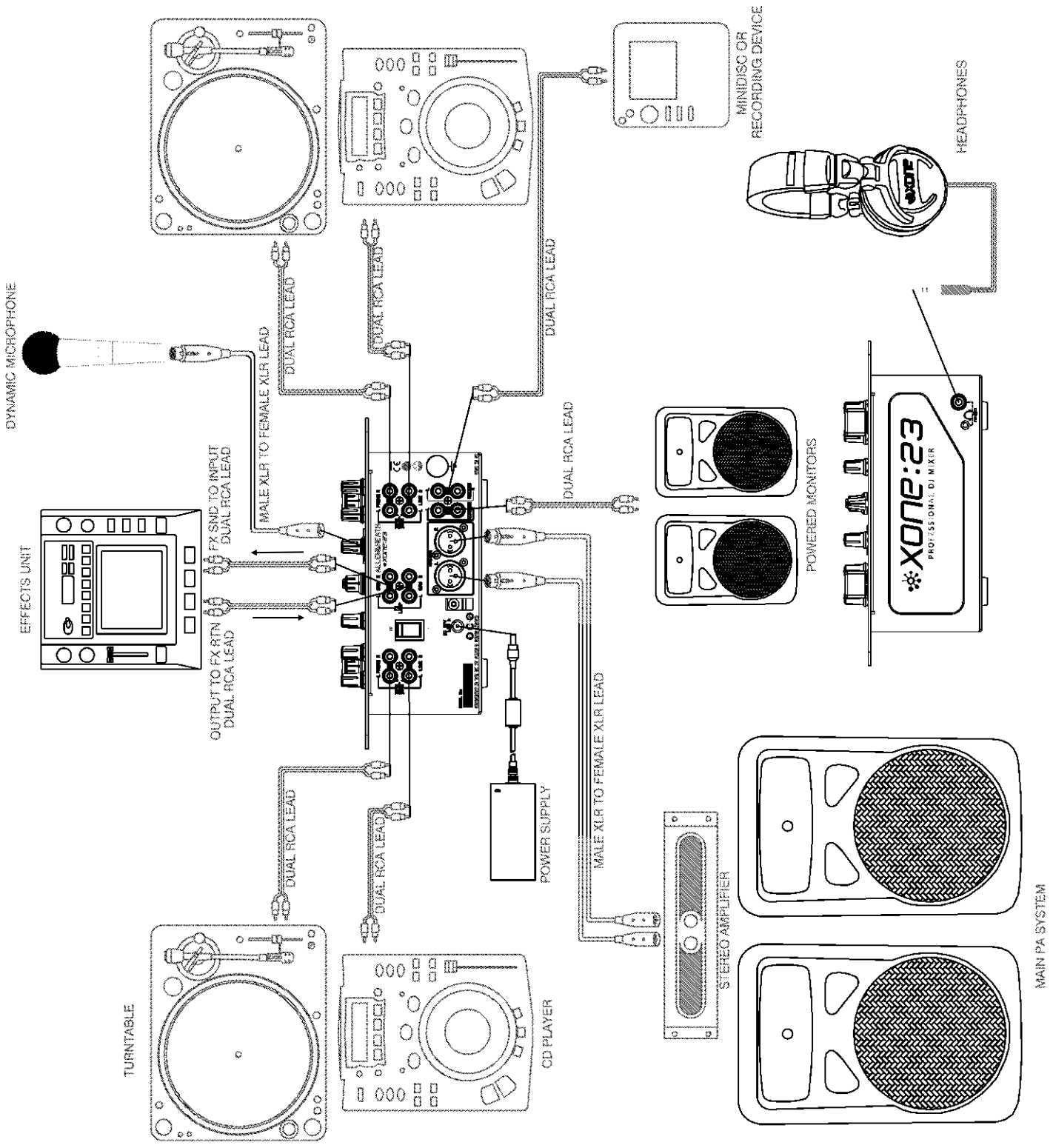

INTRODUCTION TO THE XONE:23

The Xone:23 is a high performance 2+2 channel VCA mixer designed around the latest analogue circuitry featuring microprocessor control of all signal routing.

It is equipped with a version of the famous Xone filter system, 3 band EQ, plus a send/return loop for external effects.

The crossfader curve has two settings, suitable for either blending or beat matching, or a more aggressive curve for scratching. For ultimate crossfader performance the mixer can also be equipped with a custom Innofader, available from your nearest Allen & Heath stockist, (part number 004-504JIT).

With a studio standard 20dB of signal headroom, a separate booth monitor and balanced XLR main outputs, (with an impressive +28dBu max level) the Xone:23 is perfect for the DJ who requires a high quality compact mix tool.

Key features of the Xone:23 are:

- 2+2 stereo channels with dual levels for phono/line inputs
- Up to 4 sources can be mixed simultaneously
- 3 Band equalizer
- Voltage Controlled Filter system
- Send/Return loop for external FX
- Accurate signal level monitoring with peak hold
- Main mix outputs on professional balanced XLR connectors
- Dedicated local monitor (booth monitor)
- Pro standard headroom (+20dB) to prevent overload
- +28dBu maximum output level (balanced XLR)
- Low audio distortion (typically 0.01% at +10dBu output)
- Dedicated record output
- Crossfader curve switch
- Innofader crossfader option
- Cue mix control with illuminated Cue switches
- UV sensitive ink screen for improved low light legibility
- Universal voltage power supply (works anywhere in the World)

We wish you the same fun playing on it as we have had designing it!

INPUT CHANNEL CONTROLS

Input level controls

Adjust so that the average music level lights the 0 LED on the meter, with the beats lighting the +3 to +6 LED. Turn down if the +10 Red LED is illuminated. Each input has its own separate level control, so make sure to fully turn down (anticlockwise) the input you don't want feeding into the mix.

3-Band EQ

Turn anti-clockwise to cut a frequency band or clockwise to boost.

Filter/FX SND switch

Pressing this switch sends the channel signal to the VCF filter section, **and to the external effects SND output**

Channel Cue switch

Pressing this switch allows you to monitor the channel signal with the fader fully down before bringing it into the mix.

Channel Fader

VCA fader allows you to progressively raise or lower the channel signal in the mix.

For best signal-to-noise ratio, mix with the fader at or near the top of its travel

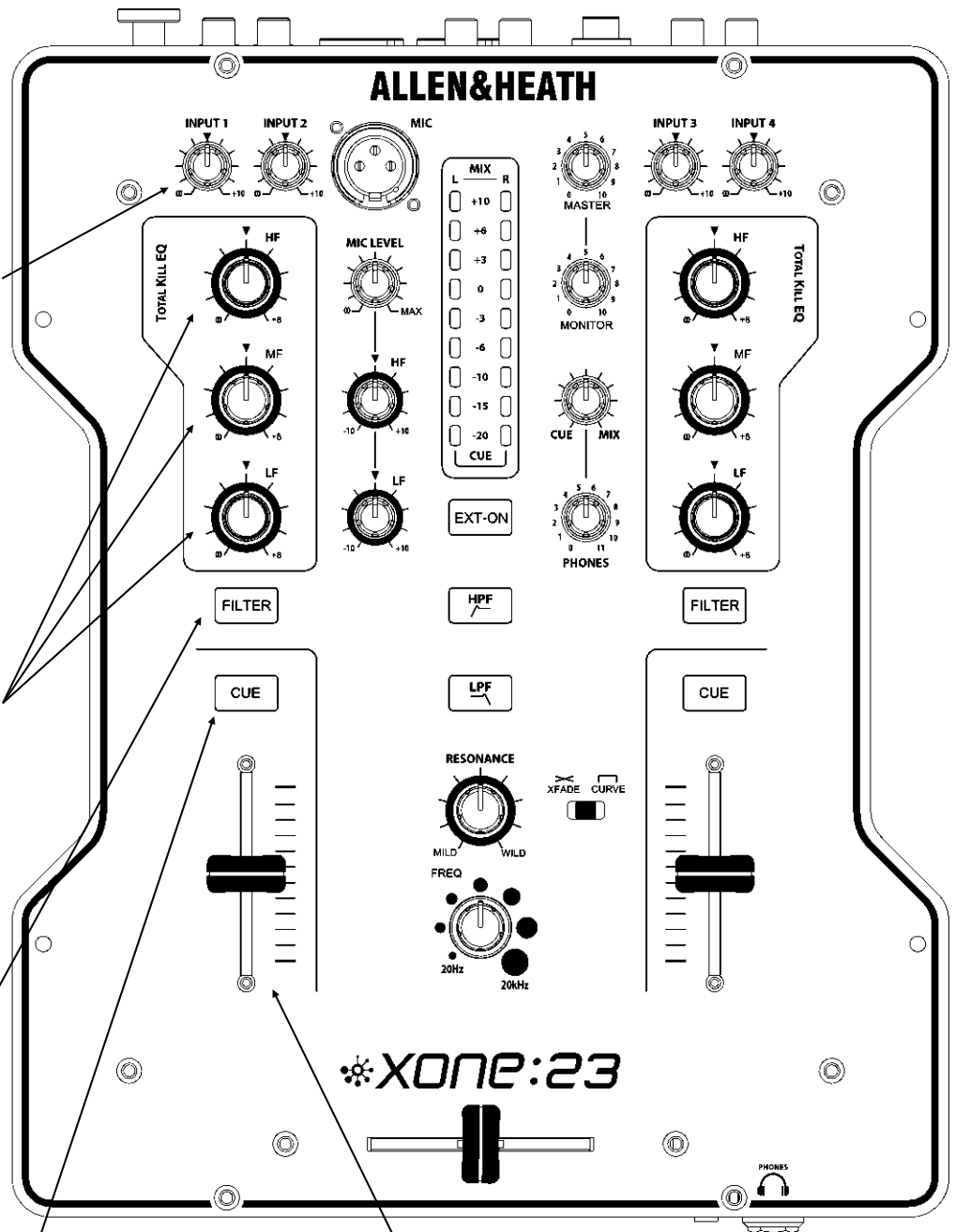

MASTER CONTROLS

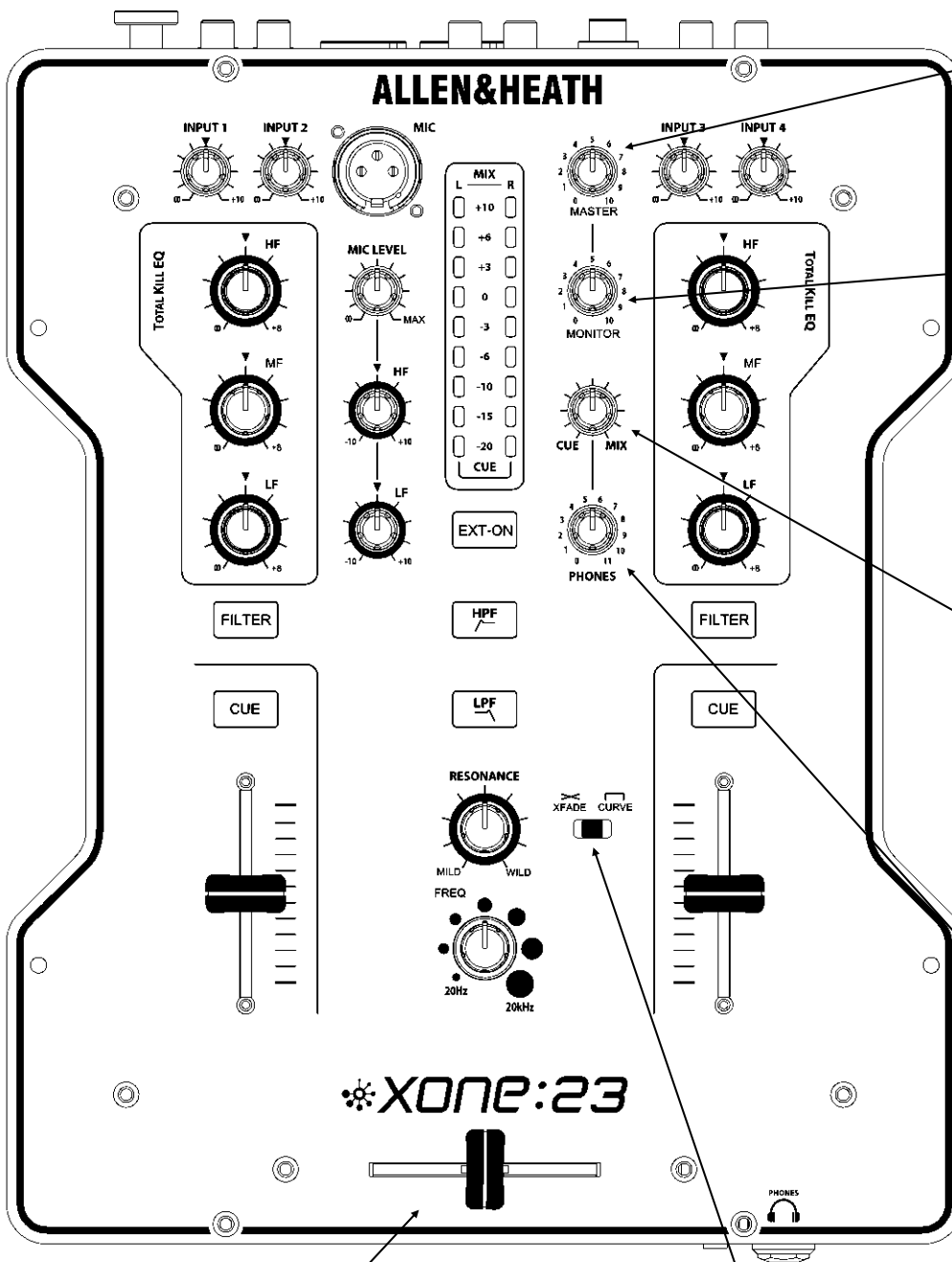

Master output Level
Sets the signal level to the main XLR mix output

Monitor output Level
Sets the signal level for the local monitor (booth) output

Cue/Mix Control
Turn left (Cue) to hear the activated channel Cue.
If no channel Cue is activated, the Mix output will be heard.
Turn right (Mix) to hear the Mix output.
In the centre position the Cue signal and the main mix are summed together.

Headphone level
Sets the level of the head-phone output.
Warning! Very high level can cause hearing damage!

Headphone Socket
Accepts both 1/4" and 3.5mm plugs. Use a good quality set with an impedance between 25 - 70 Ohms.

Crossfader
This is used to "fade" the signal level between the two channels, and its response is set using the curve switch. When the crossfader is fully over to the left only the music from channel 1 will be heard, and when fully to the right only channel 2. When in the centre the music from both channels will be heard in equal proportion.

Crossfader curve switch
Push to the left for a progressive fader response, useful for blending between tracks. Push to the right for a sharper response, more suitable for scratching

MIC AND FILTER CONTROLS

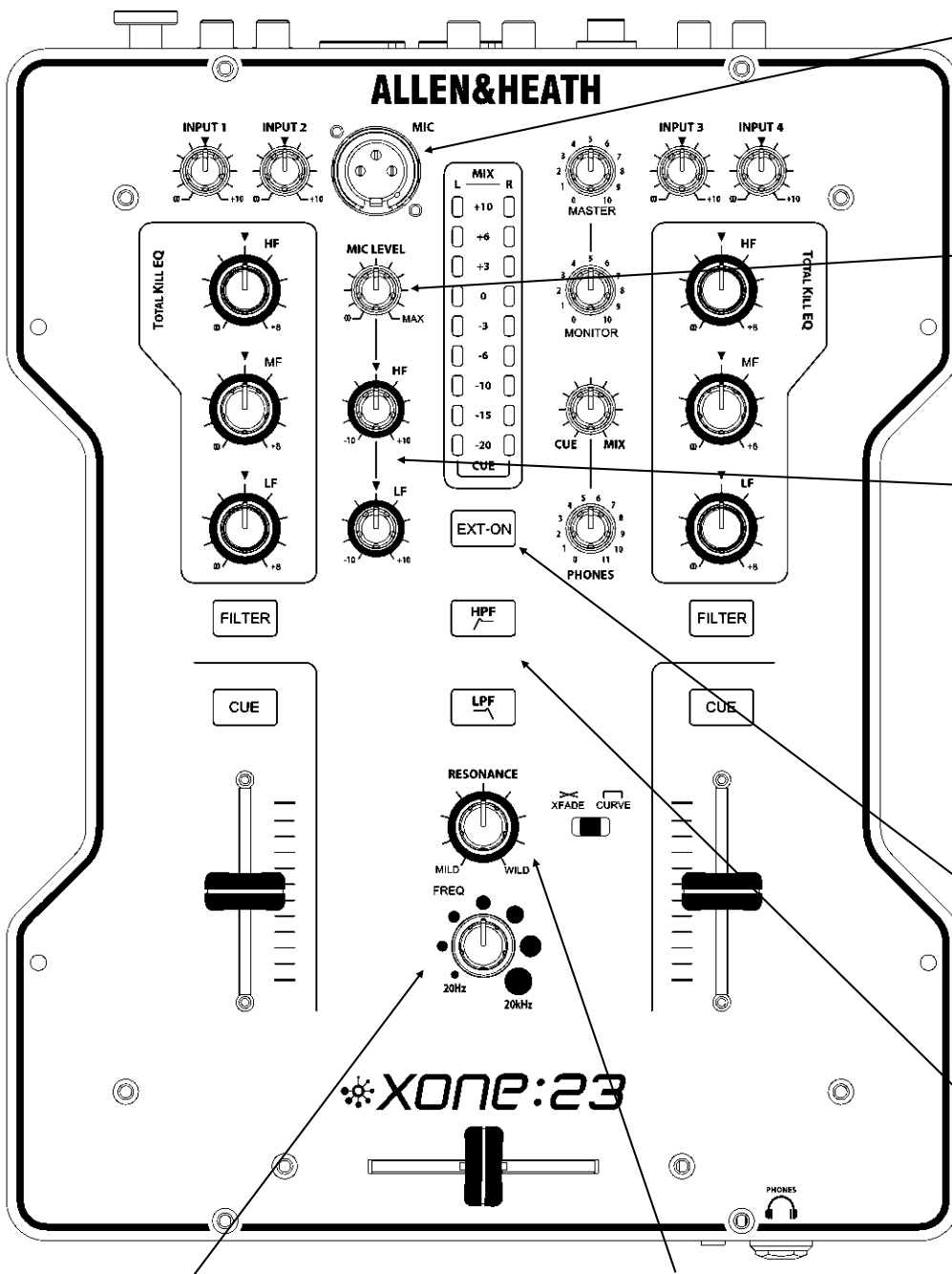

Microphone input

Professional XLR balanced mic input. Use a low impedance dynamic hypercardioid Mic for best results.

Microphone Level

Adjusts the signal level of the mic input. If you are not using the mic, turn to minimum to prevent noise pick up.

Microphone EQ

2 band EQ for adjusting the tonal balance of the DJ mic

FX loop on switch

Press this switch to activate the external effect loop. Leave switched off if an external effects unit is not connected

Filter Frequency

Sets the cut off frequency of the VCF filter

Filter Resonance control

Changes the "Q" or sharpness of the VCF.

Mild will give a smooth filter sound, Wild will make the filter sound more pronounced (sharper "Q")

Filter type select

HPF - allows signals above the cut-off frequency to pass.

LPF - allows signals below the cut-off frequency to pass

REAR PANEL CONNECTIONS

Line input

For connection to a line level device; (CD players etc)

Phono inputs

For connection to turntables only; this input has RIAA equalization for moving magnet cartridges.

Note: An internal modification can convert these to Line (see page 14)

Line input

For connection to a line level device; (CD players etc)

Effects SND output

Connect this output to the input of an external effects unit.

Effects RTN input

Connect this input to the output of an external effects unit.

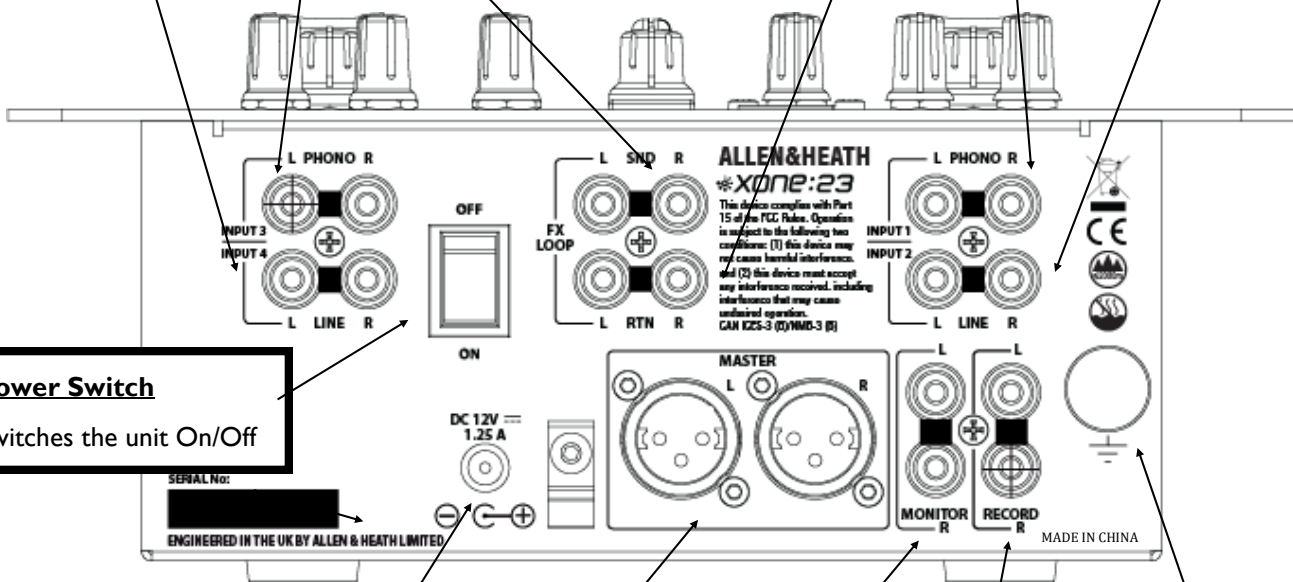

Power Switch

Switches the unit On/Off

PSU connection

To prevent damage to your Xone:23 only use an A&H approved power supply

Main outputs

Connect these to a PA amplifier using professional balanced XLR connectors for maximum hum and noise rejection.

Do not short either pins 2 or 3 to ground. For unbalanced operation use pin 2 only and leave pin 3 floating.

Failure to observe this could result in damage to your Xone:23

Monitor output

Connect to a powered speaker or Hi-Fi system

Record output

Use to record your mix. Connect to a Minidisk recorder or computer soundcard input etc

Grounding post

Connect the ground wire from turntables (if fitted) to minimise hum

FILTER REFERENCE

The VCF Filters

A voltage controlled filter is an audio filter where the cut-off frequency is altered by a DC control voltage rather than a variable resistor. This produces a much wider operating range and more control over the filter response to create unlimited combinations of tonal effect.

Filter Type Select

The filters provide two simultaneous filter types: high-pass, and low-pass. A large illuminated switch selects which type is active.

The graphs below show the effect on the audio frequency response for the two filter types. The range of sweep from low to high frequency is shown together with the effect of adjusting RESONANCE.

The vertical scale shows the amount of cut or boost around the normal 0dB operating level. The horizontal scale shows the change in frequency from low (bass) to high (treble).

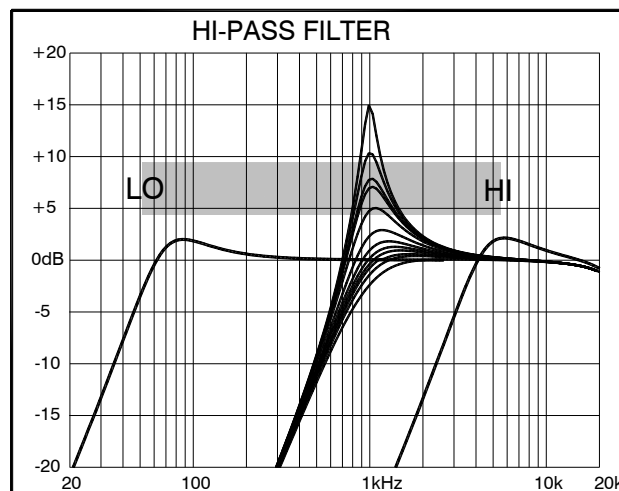
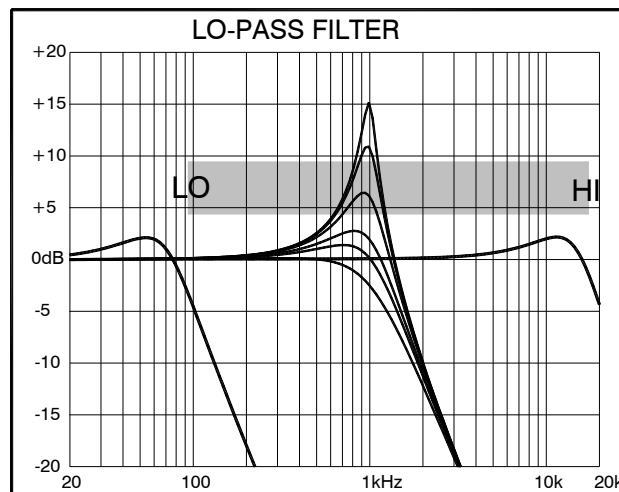

OPERATING LEVELS

It is most important that the system level settings are correctly set. It is well known that many DJs push the level to maximum with meters peaking hard in the belief that they are getting the best from the system. **THIS IS NOT THE CASE !** The best can only be achieved if the system levels are set within the normal operating range and not allowed to peak. Peaking simply results in signal distortion, not more volume. It is the specification of the amplifier / speaker system that sets the maximum volume that can be achieved, not the console. The human ear too can fool the operator into believing that more volume is needed. Be careful as this is in fact a warning that hearing damage will result if high listening levels are maintained. Remember that it is the **QUALITY** of the sound that pleases the ear, not just the **VOLUME**.

The diagram below illustrates the operating range of the audio signal.

NORMAL OPERATING RANGE. For normal music the signal should range between -6 and +6 on the meters with average around 0dB. This allows enough **HEADROOM** for unexpected peaks before the signal hits its maximum **CLIPPING** voltage and distorts.

It also achieves the best **SIGNAL-TO-NOISE RATIO** by keeping the signal well above the residual **NOISE FLOOR** (system hiss).

The **DYNAMIC RANGE** is the maximum signal swing available between the residual noise floor and clipping.

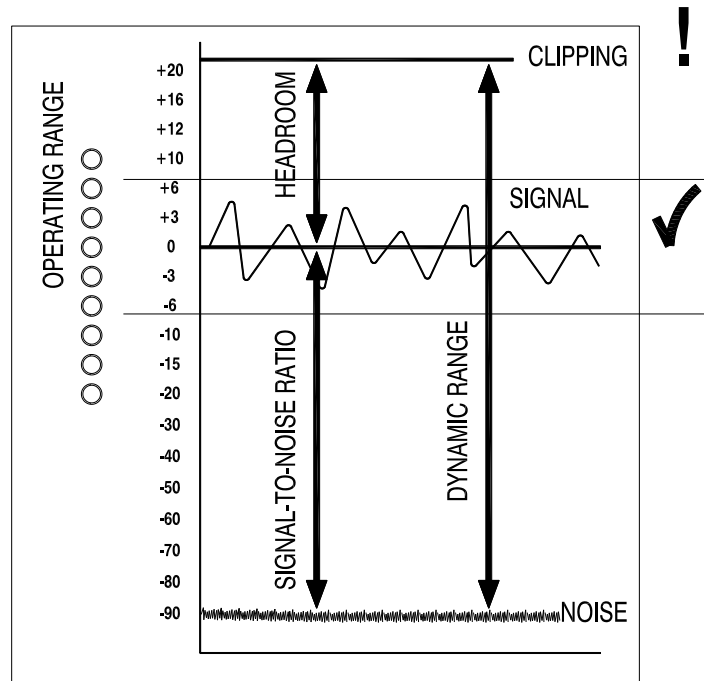

An important note ...

The human ear is a remarkable organ with the ability to compress or 'shut down' when sound levels become too high. Do not interpret this natural response as a reason to turn the system volume up further! As the session wears on ear fatigue may set in, and the speaker cones may become hot, increasing distortion and reducing the ability of listeners to gain any benefit from increased volume.

EARTHING

The connection to earth (ground) in an audio system is important for two reasons:



SAFETY - To protect the operator from high voltage electric shock, and

AUDIO PERFORMANCE - To minimise the effect of earth (ground) loops which result in audible hum and buzz, and to shield the audio signals from interference.

For safety it is important that all equipment earths are connected to mains earth so that exposed metal parts are prevented from carrying high voltage which can injure or even kill the operator. It is recommended that a qualified system engineer check the continuity of the safety earth from all points in the system including microphone bodies, turntable chassis, equipment cases, and so on.

The same earth is also used to shield audio cables from external interference such as the hum fields associated with power transformers, lighting dimmer buzz, and computer radiation. Problems arise when the signal sees more than one path to mains earth. An 'earth loop' (ground loop) results causing current to flow between the different earth paths. This condition is usually detected as a mains frequency audible hum or buzz.

To ensure safe and trouble-free operation we recommend the following:

Have your mains system checked by a qualified electrician. If the supply earthing is solid to start with you are less likely to experience problems.

Make sure that turntables are correctly earthed. A chassis earth terminal is provided on the console rear panel to connect to turntable earth straps.

Use low impedance sources such as microphones and line level equipment rated at 200 ohms or less to reduce susceptibility to interference. The console outputs are designed to operate at very low impedance to minimise interference problems.

Use balanced connections for microphones and mix output as these provide further immunity by cancelling out interference that may be picked up on long cable runs.

Do not unbalance the Xone:23 XLR outputs by shorting pin 3 to ground as this may damage the circuitry; for unbalanced operation connect the hot signal to pin 2 and the ground to pin 1. Leave pin 3 floating.

Use good quality cables and connectors and check for correct wiring and reliable solder joints. Allow sufficient cable loop to prevent damage through stretching.

If you are not sure ... Contact your service agent or local Allen & Heath dealer for advice.

SERVICING

How to replace the crossfader

If the crossfader is subject to a lot of use it will, in time wear out and need replacing. Intermittent or noisy operation is an indication that it is becoming worn. Using a propriety fader cleaner such as CaigLube might temporarily restore use, but DO NOT use on a new fader as it will wash away the factory applied grease.

Warning! Dismantling your mixer could invalidate the warranty; if you are unsure of your ability to safely carry out this work then it is advised that you leave it to a qualified service technician.

Tools you will need are T10, and T8 Torx screwdrivers. Ensure that the power supply has been turned off and disconnected from the unit. Using the T10 torxdriver remove the three screws located in the centre of the channel input and FX loop connectors (see illustration), then using the T8 torxdriver remove the 8 screws that hold the front panel to the chassis. Now carefully lift the front edge of the panel up until the PCBs clear the chassis and pull the whole assembly forward slightly until the connectors at the rear are free from the chassis. You can now lift the front panel up to gain sufficient access to replace the crossfader.

If you wish to completely remove the front panel assembly you will need to unscrew the 1/4" headphone bezel using an 11mm or 7/16 AF socket, and remove the T10 screw that secures the headphone PCB to the chassis. Carefully unplug the multi-way harness from the connector PCB and lift the front panel away from the chassis.

Reassembly is a reverse of this procedure. Take great care to ensure that no harnesses become trapped and that all connectors are fully pushed home. Replace the screws and test the mixer for correct operation.

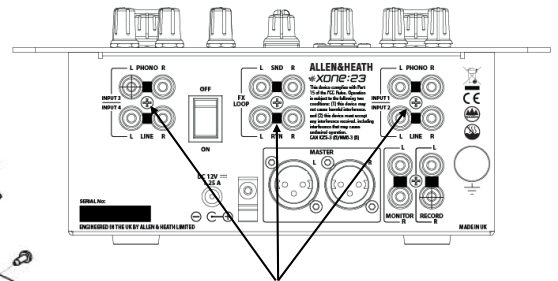

REMOVE THE T10 SCREWS ARROWED

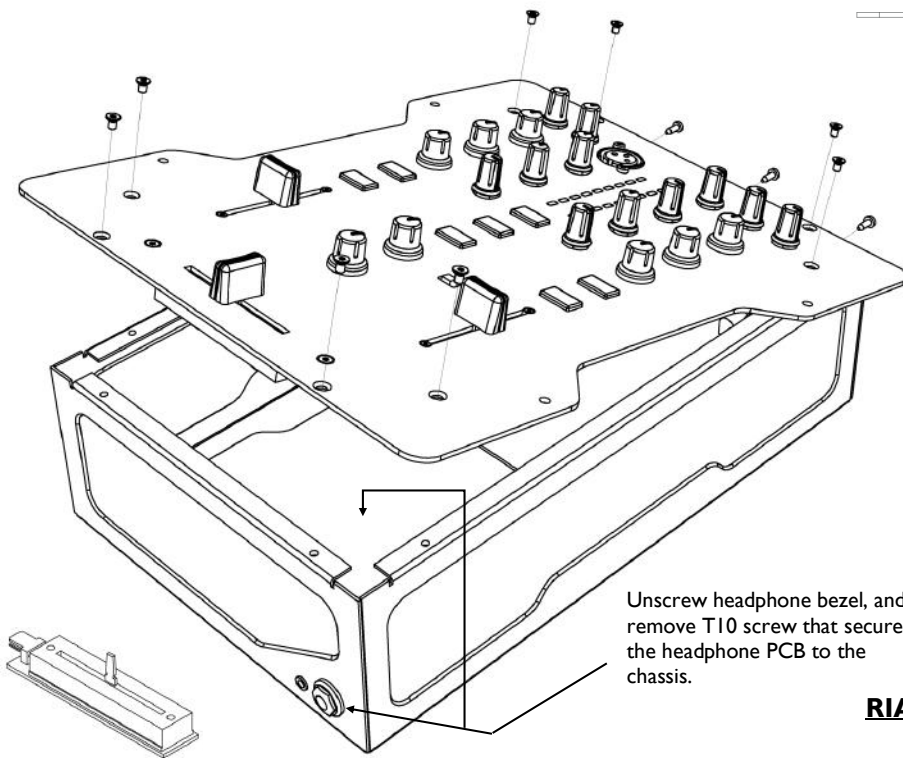

Unscrew headphone bezel, and remove T10 screw that secures the headphone PCB to the chassis.

RIAA input options

To Replace the crossfader

Using the T8 driver, remove the 2 screws either side of the crossfader and lower the crossfader mounting plate - unplug the 4way harness from the crossfader PCB, and unscrew the fader from the mounting plate

The mounting plate is designed to allow for fitment of the contactless Innofader and can be fitted in two different positions depending which fader is being fitted.

The standard fader can be ordered under A&H part number 004-503JIT

The Innofader can be ordered under part number 004-504JIT

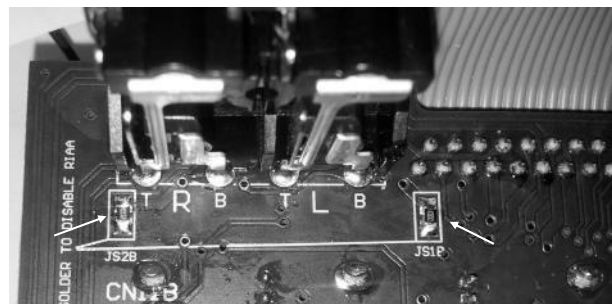

If the RIAA input level is too low, or you wish to convert them to Line level. To increase the gain by 6dB, remove the resistors arrowed and link the Pads with solder. These resistors are located on the underside of the front panel PCB, directly behind the Input RCA connectors

To convert to Line level, remove the resistors and leave the Pads unsoldered.

USER-REPLACEABLE PARTS

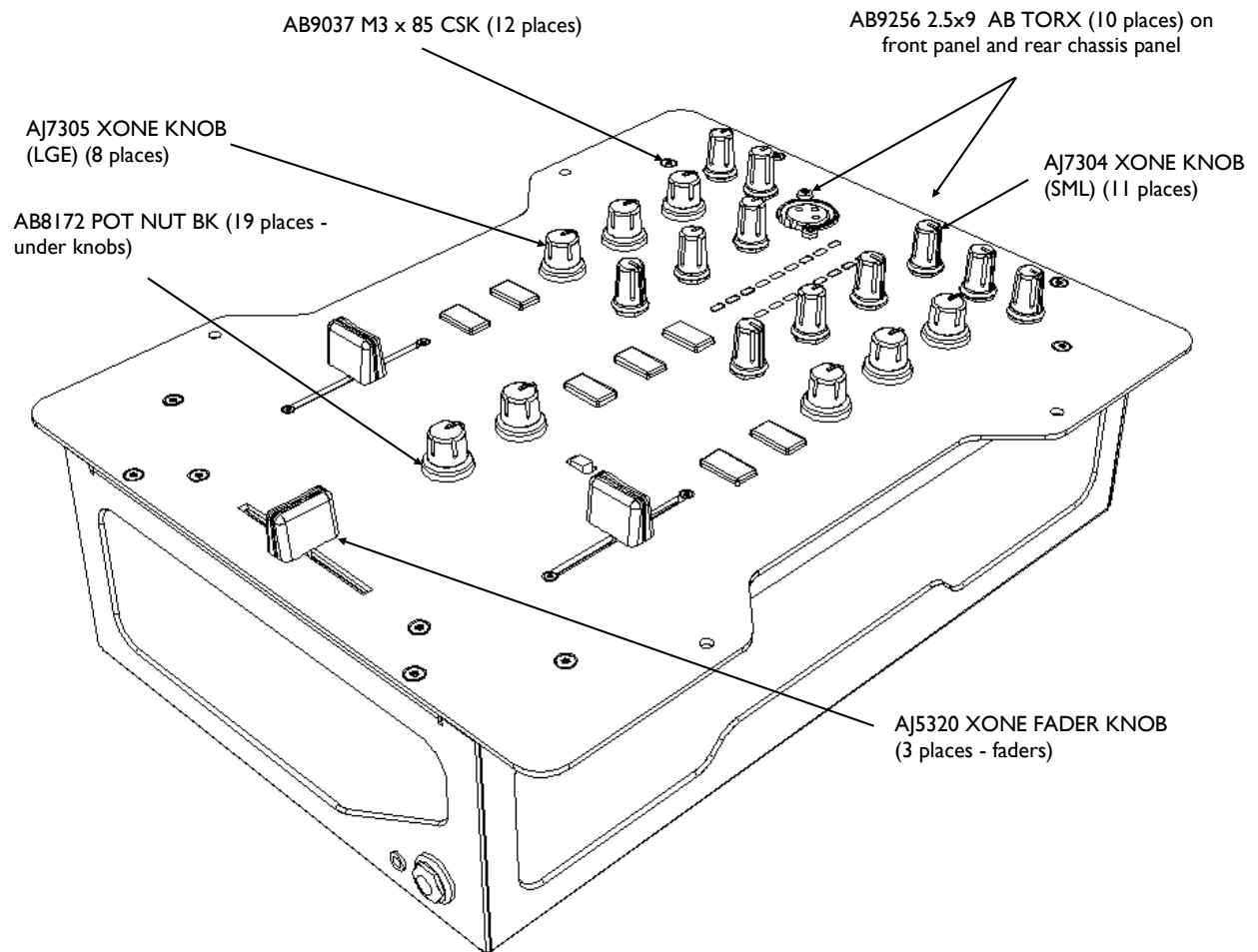

The diagram above shows all of the replacement parts.
When ordering please quote the part number(s) of the required parts.

See the previous page for information on replacing the crossfader, and for replacement cross-fader assembly numbers.

FAULT FINDING

No sound from mixer

Check that the unit is powered on, and that an audio signal is connected to a channel input.

Check that the Input level controls are turned clockwise at least to the centre position and that the music sources connected are in the correct inputs (Inputs 1 - 3 for turntables, Inputs 2 - 4 for CD players).

Check that the EQ controls are in the centre position.

Turn On the Channel CUE switch and raise the input channel LEVEL control until you see the meters displaying the music signal.

Raise the channel fader, and ensure that the crossfader is towards the channel that is receiving the audio signal.

Turn up the MASTER, MONITOR or HEADPHONE level controls, depending on what output your amplifier is connected to, or if you are monitoring through headphones.

External effects unit can't be heard

Check that the Effects unit is connected correctly (see page 5) and switched on - the SND on the rear panel of the mixer should be connected to the input socket on the external effects unit, and the output from the effects unit should be connected to the RTN.

Check that the EXT - ON switch is on (illuminated RED) and that the channel FILTER switch is ON (illuminated BLUE).

Signal is loud and distorted

Check that the audio source is connected to the correct input; i.e. don't connect a CD player to the PHONO input.

Adjust the channel input LEVEL so that the meters peak the +3 or +6 LEDs. If the red +10 meter LED comes on, turn down the channel LEVEL control.

SPECIFICATIONS

Connections

Inputs

	<u>Connection</u>	<u>Impedance</u>	<u>Nominal Level</u>	<u>Maximum Level</u>
Phono	RCA	47K/330pF	7mV-100mV	
Line	RCA	20K ohm	-10 to +20dBu	
FX RTN	RCA	10K ohm	0 to +20dBu	
Mic	XLR	<2K ohm	-42 TO -12dBu	

Outputs

Main Mix	Balanced XLR	100 ohms	+4dBu	+28dBu
Monitor	RCA	100 ohms	-2dBu	+22dBu
Record	RCA	100 ohms	-2dBu	+19dBu
FX SND	RCA	100 ohms	-2dBu	+19dBu
Headphones	3.5mm and 1/4" TRS Jacks	1 ohm		200mW RMS into 30 ohms

Performance

Distortion	Main Mix out	+10dBu	0.01% THD+N
Noise 22-22Khz	Main Mix out	unity	-85dBu un-weighted
Fader shut off	Channel fader		>-80dB
Xfade shut off	Xfader		>-80dB
Frequency Response		10Hz to 50kHz	+/-0dB

Dimensions

Weight 2.7kg (6lb)

Weight Packed 4kg (8.8lb)

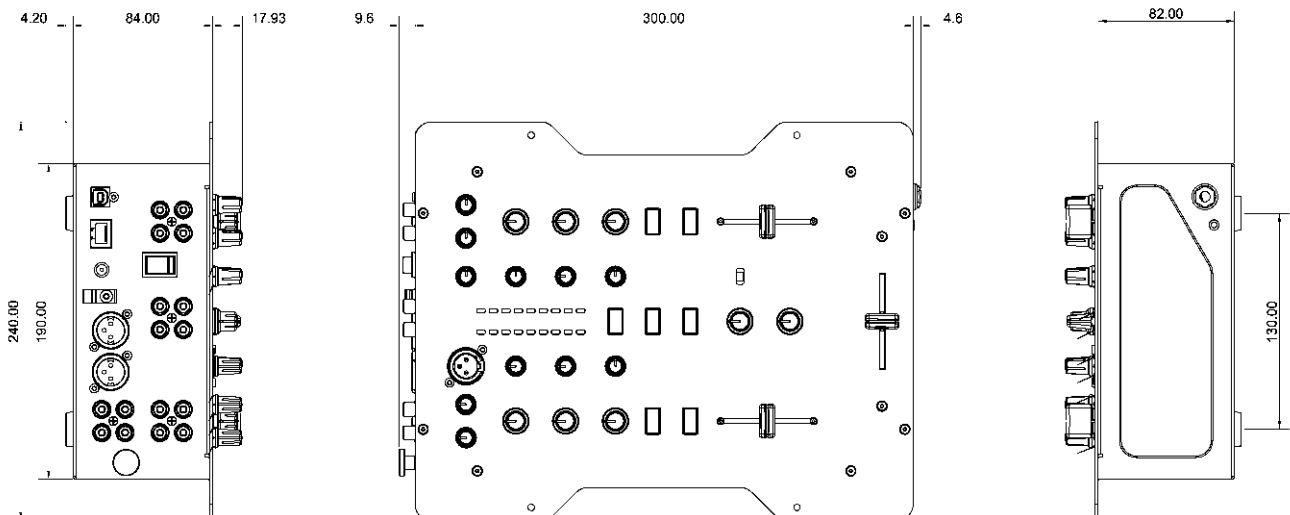

BLOCK DIAGRAM

XONE:23 BLOCK DIAGRAM

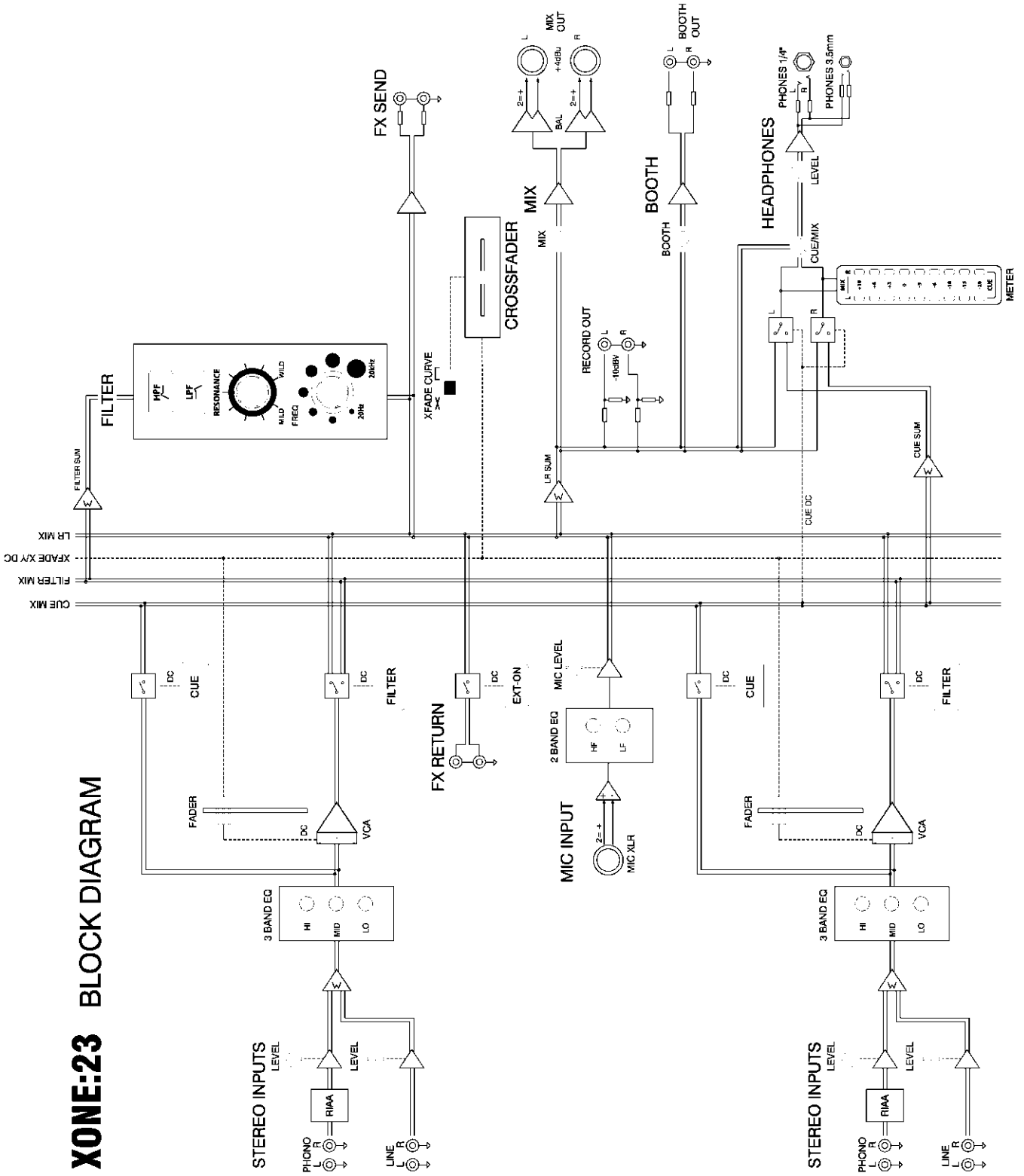

PRODUCT REGISTRATION

Registering your product

Please register your product with Allen&Heath online at:

<http://www.allen-heath.com/support/register-product/>