

ALLEN & HEATH

 **XONE:464**
P R O F E S S I O N A L C L U B M I X E R

USER GUIDE

Publication AP4147

Limited One Year Warranty

This product has been manufactured in the UK by ALLEN & HEATH and is warranted to be free from defects in materials or workmanship for period of one year from the date of purchase by the original owner.

To ensure a high level of performance and reliability for which this equipment has been designed and manufactured, read this User Guide before operating. In the event of a failure, notify and return the defective unit to ALLEN & HEATH or its authorised agent as soon as possible for repair under warranty subject to the following conditions

Conditions Of Warranty

1. The equipment has been installed and operated in accordance with the instructions in this User Guide
2. The equipment has not been subject to misuse either intended or accidental, neglect, or alteration other than as described in the User Guide or Service Manual, or approved by ALLEN & HEATH.
3. Any necessary adjustment, alteration or repair has been carried out by ALLEN & HEATH or its authorised agent.
4. This warranty does not cover crossfader wear and tear.
5. The defective unit is to be returned carriage prepaid to ALLEN & HEATH or its authorised agent with proof of purchase.
6. Units returned should be packed to avoid transit damage.

These terms of warranty apply to UK sales. In other territories the terms may vary according to legal requirements. Check with your ALLEN & HEATH agent for any additional warranty which may apply.



This product complies with the European Electromagnetic Compatibility directives 89/336/EEC & 92/31/EEC and the European Low Voltage Directives 73/23/EEC & 93/68/EEC.

This product has been tested to EN55103 Parts 1 & 2 1996 for use in Environments E1, E2, E3, and E4 to demonstrate compliance with the protection requirements in the European EMC directive 89/336/EEC. During some tests the specified performance figures of the product were affected. This is considered permissible and the product has been passed as acceptable for its intended use. Allen & Heath has a strict policy of ensuring all products are tested to the latest safety and EMC standards. Customers requiring more information about EMC and safety issues can contact Allen & Heath.

NOTE: Any changes or modifications to the console not approved by Allen & Heath could void the compliance of the console and therefore the users authority to operate it.

XONE:464 User Guide AP4147 Issue 4

Copyright © 2001 Allen & Heath Limited. All rights reserved

Allen & Heath Limited
Kernick Industrial Estate, Penryn, Cornwall, TR10 9LU, UK
<http://www.allen-heath.com>

Important Safety Instructions

WARNINGS - Read the following before proceeding :



ATTENTION: RISQUE DE CHOC ELECTRIQUE – NE PAS OUVRIR

- Read instructions:** Retain these safety and operating instructions for future reference. Adhere to all warnings printed here and on the console. Follow the operating instructions printed in this User Guide.
- Do not remove covers:** Operate the console with its covers correctly fitted. Disconnect mains power by unplugging the power cord if the covers need to be removed for setting internal options. Refer this work to competent technical personnel only.
- Power sources:** Connect the console to a mains power only of the type described in this User Guide and marked on the rear panel. Use the power cord with sealed mains plug appropriate for your local mains supply as provided with the console. If the provided plug does not fit into your outlet consult your service agent for assistance.
- Power cord routing:** Route the power cord so that it is not likely to be walked on, stretched or pinched by items placed upon or against it.
- Grounding:** Do not defeat the grounding and polarisation means of the power cord plug. Do not remove or tamper with the ground connection in the power cord.



WARNING: This equipment must be earthed.

- Water and moisture:** To reduce the risk of fire or electric shock do not expose the console to rain or moisture or use it in damp or wet conditions. Do not place containers of liquids on it which might spill into any openings.
- Ventilation:** Do not obstruct the ventilation slots or position the console where the air flow required for ventilation is impeded. If the console is to be operated in a rack unit or flightcase ensure that it is constructed to allow adequate ventilation.
- Heat and vibration:** Do not locate the console in a place subject to excessive heat or direct sunlight as this could be a fire hazard. Locate the console away from any equipment which produces heat or causes excessive vibration.
- Servicing:** Switch off the equipment and unplug the power cord immediately if it is exposed to moisture, spilled liquid, objects fallen into the openings, the power cord or plug become damaged, during lightening storms, or if smoke, odour or noise is noticed. Refer servicing to qualified technical personnel only.
- Installation:** Install the console in accordance with the instructions printed in this User Guide. Do not connect the output of power amplifiers directly to the console. Use audio connectors and plugs only for their intended purpose.



Important Mains plug wiring instructions.

The console is supplied with a moulded mains plug fitted to the AC mains power lead. Follow the instructions below if the mains plug has to be replaced.

The wires in the mains lead are coloured in accordance with the following code:

TERMINAL		WIRE COLOUR	
		European	USA/Canada
L	LIVE	BROWN	BLACK
N	NEUTRAL	BLUE	WHITE
E	EARTH GND	GREEN & YELLOW	GREEN

The wire which is coloured Green and Yellow must be connected to the terminal in the plug which is marked with the letter E or with the Earth symbol. **This appliance must be earthed.**

The wire which is coloured Blue must be connected to the terminal in the plug which is marked with the letter N.

The wire which is coloured Brown must be connected to the terminal in the plug which is marked with the letter L.

Ensure that these colour codes are followed carefully in the event of the plug being changed.

Precautions

- Damage :** To prevent damage to the controls and cosmetics avoid placing heavy objects on the control surface, scratching the surface with sharp objects, or rough handling and vibration.
- Environment :** Protect from excessive dirt, dust, heat and vibration when operating and storing. Avoid tobacco ash, smoke, drinks spillage, and exposure to rain and moisture. If the console becomes wet, switch off and remove mains power immediately. Allow to dry out thoroughly before using again.
- Cleaning :** Avoid the use of chemicals, abrasives or solvents. The control panel is best cleaned with a soft brush and dry lint-free cloth. The faders, switches and potentiometers are lubricated for life. The use of electrical lubricants on these parts is not recommended.
- Transporting :** The console may be transported as a free-standing unit or mounted in a rack or flightcase. Ensure that the connector pod is secured in place with the locking screws fitted to prevent movement. Protect the controls from damage during transit. The faders are best positioned at the top of their travel if the console is transported without a suitable flightcase, rack or carton. Use adequate packing if you need to ship the unit.

Introduction

This user guide presents a quick reference to the function and application of the **XONE:464**. We recommend that you read this fully before starting. Included is information on installing, connecting and operating the console, panel drawings, system block diagram and technical specification. For further information on the basic principles of audio system engineering, please refer to one of the specialist publications available from bookshops and audio equipment dealers.

Whilst we believe the information in this guide to be reliable we do not assume responsibility for inaccuracies. We also reserve the right to make changes in the interest of further product development.

Note that this user guide refers to the revised model **XONE:464**. This has minor changes from the original model. Details are provided in the addendum at the rear of this guide.

We are able to offer further product support through our world-wide network of approved dealers and service agents. You can also access our Web site on the Internet for information on our product range, assistance with your technical queries or simply to chat about matters audio. To help us provide the most efficient service please keep a record of your console serial number, and date and place of purchase to be quoted in any communication regarding this product.

Contents

Warranty	2	Connecting Auxiliary Outputs.....	18
Important Safety Instructions	3	Connecting Phones and Monitor	19
Precautions	4	User Connector Options.....	19
Front and Rear Panel Drawings.....	6	Mono Input Channel.....	20
Welcome to the XONE:464	7	Stereo Input Channel.....	22
Specifications	8	Crossfader	24
Block Diagram.....	9	Replacing the Crossfader.....	25
Input and Output Connections	9	VCF Filters	26
Quick Start.....	10	External Input.....	28
Installing the Console.....	13	Master Mix.....	29
Connecting Mains Power.....	14	Console Monitor System	30
Earthing	14	Club Application	33
Plugging up the System.....	15	Options	34
Connecting the Mono Channel.....	16	Addendum: Model Changes	34
Connecting the Stereo Channel	17	Tips and Troubleshooting	35
Connecting the External Input	17	Cue Sheet.....	Rear Cover
Connecting Mix1,2 Outputs	18		

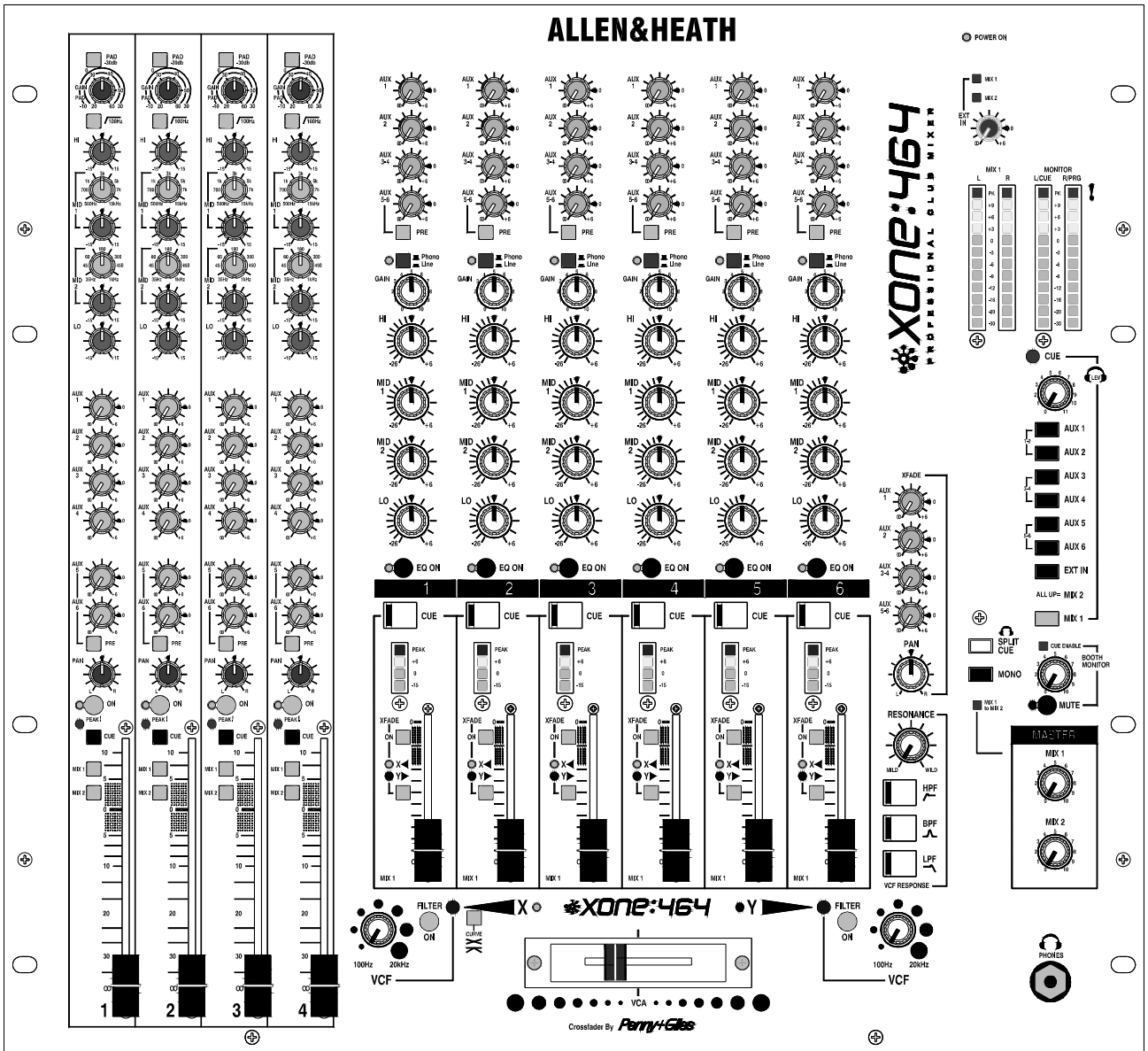
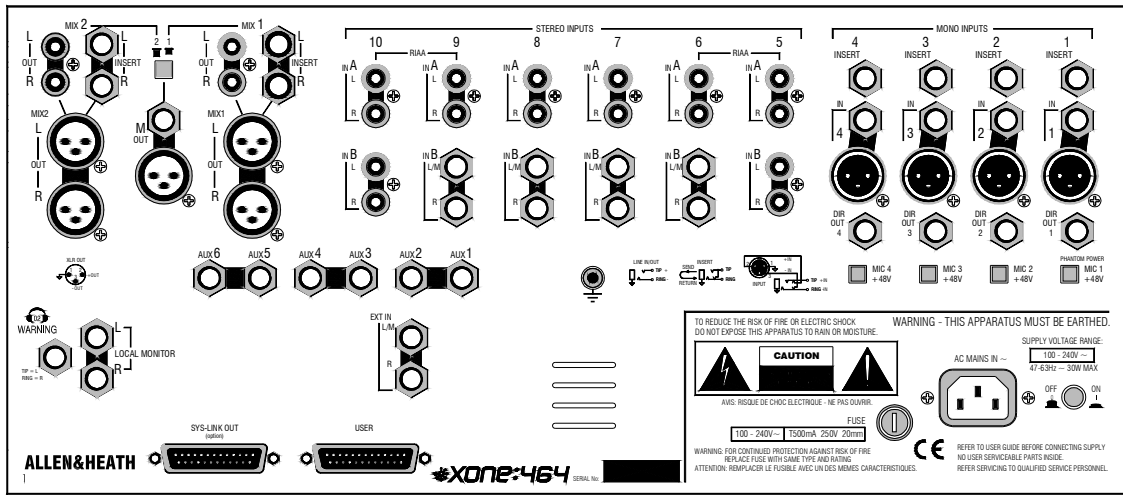

Welcome to the XONE:464

The Allen & Heath **XONE:464** presents a unique concept in combining a professional live sound mixer with a serious DJ performance tool in a dedicated club format. And, above all, it features sound quality second to none. **XONE:464** has been designed and constructed using the same rigorous standards we apply to our large format professional consoles used and respected by top engineers throughout the world. We have had great fun designing this new range. We are sure you will get even more enjoyment using it.

MONO Inputs The 4 mic/line inputs are ideal for live performances, or for your MC, DJ and presenter microphones. An extensive Aux system lets you provide artists with individual stage monitors, helping them to give their best performance. It can also feed multiple effects processors such as reverb and delay. A 4 band EQ with swept frequency mids is the same as that found on top end professional consoles, and helps you deal with source problems, enhance clarity or sweeten the live mix. Insert jacks let you patch in channel processors such as compressors to help control the dynamic range of individual microphones. Smooth 100mm faders with 10dB available boost provide fine precision for live mixing. Direct outputs are provided for recording, spot effects or channel linking.

STEREO Inputs The 6 dual stereo channels allow selection of up to 12 stereo sources including 4 RIAA turntables. The 4 band performance EQ gives you a unique extra band for solid bass control. Boost restricted to 6dB prevents system overload while an extended cut of up to a massive 26dB provides complete sound sculpturing. Full routing lets you assign any channel direct to the main mix or through either X or Y crossfader channels. Large illuminated Cue switches and signal meters keep you in control of your sources. The Aux system is tucked out of the way of the performance controls and provides 2 mono and 2 stereo feeds for monitors, effects, recording or additional zones.

EXT Input Provides an additional stereo input to Mix1, Mix2 or both, ideal for stage reverb returns or sub inputs. Or it can be configured as an external monitor source.

VCA Crossfader Uses a DC voltage to control the audio meaning no clicks, bangs or crackles as the fader wears. The crossfade curve can be set for either 6dB dip in the middle, ideal for seamless beat mixing, or for constant level, better suited to scratch mixing. The fader is removable from the front panel for quick replacement. Crossfader output can be fed to the Aux system which means that you can provide zone and effects feeds from your mix. A Pan control provides yet more performance effect.

VCF Filters Unique to **XONE**, two stereo state variable Voltage Controlled Filters provide the DJ with a new tool for live performance creativity. These are very similar to those found on classic analogue synths but benefit from modern, quiet and stable technology. Use these to sweep the sound by accentuating or cutting frequencies from 100Hz to 20kHz. The 3 filter types HPF, BPF and LPF can be combined to create many more amazing effects. A large Resonance control changes the 'Q' or sharpness of the filter effect from subtle to extreme. Each VCF has its own in/out switch to toggle the effect on or off.

MIX Outputs Mix1 and Mix2 are two independent stereo mixes on balanced XLR and with inserts for patching in limiters and other processors. Use Mix1 for music only and Mix2 for music + mics, or use them as completely different mixes, ideal when you want to create separate stage and DJ mixes feeding independent rigs. Both include additional stereo outputs suitable for recording your mix. A twin connector Mono output sums the L and R signals from either Mix1 or Mix2 to provide additional mono zone and/or lighting controller feeds.

MONITOR Section Extensive monitoring is provided so that you can keep a check on every input and output signal to prevent overload and to cue your mix. A stereo meter always shows Mix1 output level, another the selected monitor or cue source. An 8 way switch bank selects which output to monitor, and is automatically overridden by any Cue pressed. Two pairs of headphones can be plugged in. Split-CUE allows accurate track matching. An independent stereo Booth Monitor feed includes Cue enable, Mono sum and Mute functions to satisfy all your monitoring needs.

Specifications

0dBu = 0.775 Volts rms	+4dBu = 1.23V rms
0dBV = 1 Volt rms	-10dBV = 316mV rms
Maximum output level	XLR +26dBu into >2k ohm load TRS jack +21dBu into >2k ohm load RCA phono +15dBu into >10k ohm load
Internal headroom	Channels +21dB Mix to output +23dB
Peak indicators	Turn on 9dB before clipping
Meters	MIX1 / MONITOR Peak reading 12 led 3 colour
Frequency response	+0/-1dB 20Hz to 40kHz
Distortion	< 0.006% THD+noise measured at +14dBu 1kHz
Crosstalk	< 90dB Channel shutoff measured at 1kHz
Noise	Measured rms 22Hz to 22kHz
MIC EIN	-128dB referred to 150 ohm source
Residual output noise	XLR -90dBu (-94dB S/N) TRS jack -84dBu (-84dB S/N) RCA phono -92dBu (-84dB S/N)
Mix noise, ch routed	XLR -86dBu (-90dB S/N) TRS jack -83dBu (-83dB S/N) RCA phono -91dBu (-83dB S/N)

Power Supply

Internal switch mode power unit with auto sensing mains input.

MAINS IN socket	IEC 3 pin
Power lead	Country dependent with moulded mains plug supplied
AC mains	100 to 240V AC @ 50/60Hz
Consumption	30W max
Mains fuse rating	100-240V AC T500mA 20mm

Dimensions and Weights

The connector pod can be rotated and fixed in one of two positions to allow either desktop operation with rear facing connectors, or 19" rack mounting with underside connectors in 10U space.

	<u>Width</u>	<u>Height</u>	<u>Depth</u>
Desktop	483mm (19")	192mm (7.6")	530mm (20.9")
Rack mounted	483mm (19")	444mm (17.5") 10U	135mm (5.3")
Packed	590mm (23.2")	260mm (10.2")	610mm (24")
	<u>Unpacked</u>	<u>Packed</u>	
Weight	10kg (22lbs)	13kg (29lbs)	

Connector Types

XLR connections are Pin 2 = hot (+) Pin 3 = cold (-) Pin 1 = GND
 TRS input and output connections are Tip = hot (+) Ring = cold (-) Sleeve = GND
 TRS insert connections are Tip = SEND Ring = RETURN Sleeve = GND



XONE2: 464 BLOCK DIAGRAM

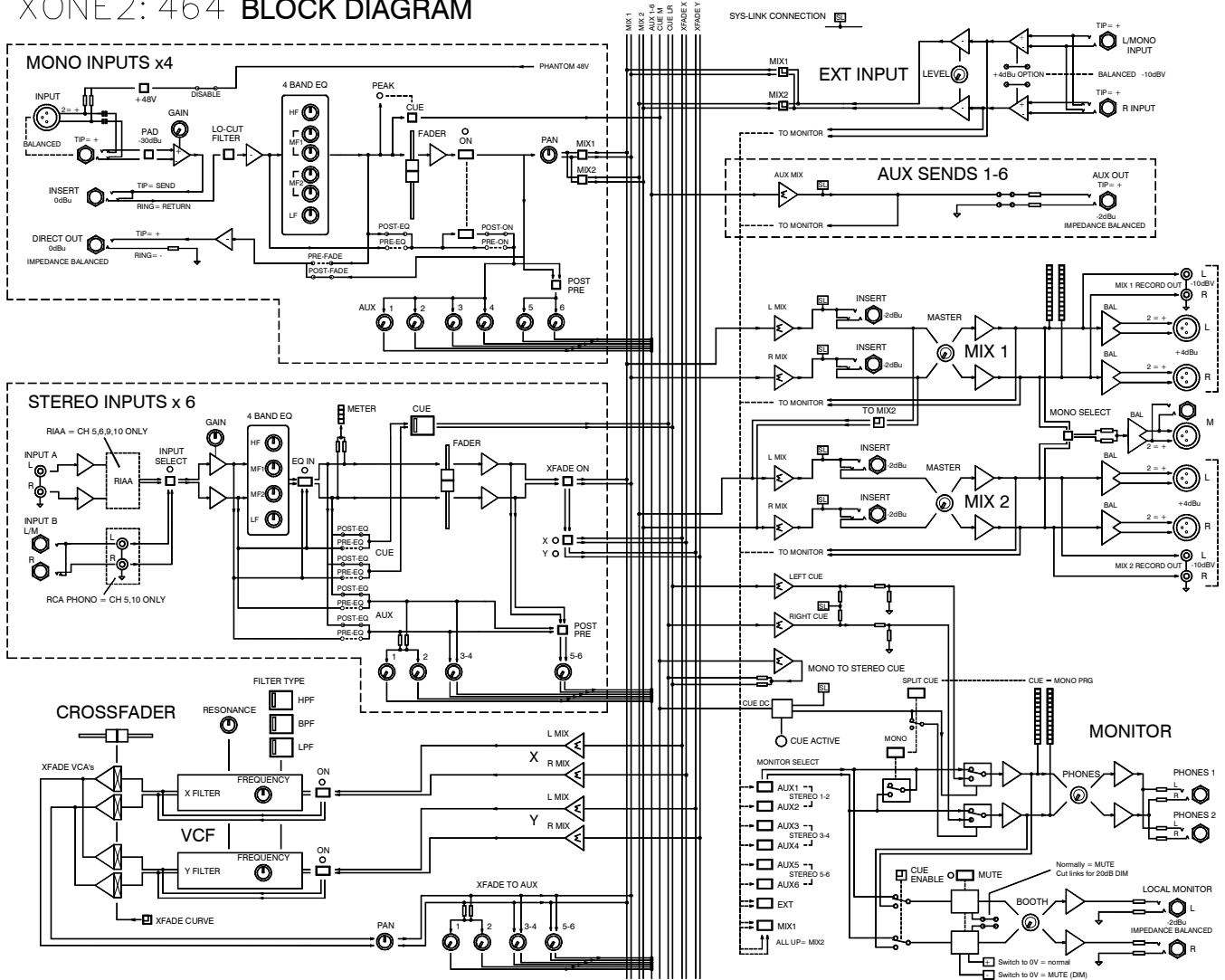

Input Connections

CH 1-4 in (XLR)	Balanced XLR female	2k ohm	-60 to -20dBu	PAD out
		>10k ohm	-30 to +10dBu	PAD in
CH 1-4 in (TRS)	Balanced TRS jack	>10k ohm	-30 to +10dBu	
CH 5,6,9,10 in A	RCA phono RIAA	47kohm/330pF	2 to 100mV	
CH 7,8 in A	RCA phono	>10k ohm	-10 to +10dBu	
CH 5,10 in B	RCA phono	>10k ohm	-10 to +10dBu	
CH 6,7,8,9 in B	Balanced TRS jack	>10k ohm	-10 to +10dBu	
EXT in	Balanced TRS jack	> 10k ohm	-10dBV (+4dBu option)	

Inserts

CH 1-4	Unbalanced TRS jack	SEND/RET	<75/>3k ohm	0dBu
MIX out 1,2	Unbalanced TRS jack	SEND/RET	<75/>3k ohm	-2dBu

Output Connections

DIR out 1-4	Impedance balanced TRS jack	<75 ohm	0dBu
MIX out 1,2 (XLR)	Balanced XLR male	<75 ohm	+4dBu
MIX out 2 (RCA)	RCA phono	<75 ohm	-10dBV
MONO out (XLR)	Balanced XLR male	<75 ohm	+4dBu
MONO out (TRS)	Impedance balanced TRS jack	<75 ohm	-2dBu
AUX out 1-6	Impedance balanced TRS jack	<75 ohm	-2dBu
LOCAL MON out	Impedance balanced TRS jack	<75 ohm	-2dBu
Headphones 1,2	Tip = L Ring = R	30 to 600 ohm recommended	

Quick Start

We recommend that you read through all sections of this User Guide before starting. However, we provide these notes so that you can plug up and experiment with sounds from your **XONE:464** immediately if you prefer to read the full guide later. Please note that you should first read and understand the **Important Safety Instructions** printed at the beginning of this guide. This simple procedure requires a microphone, CD player and headphones. Alternatively you can connect a pair of turntables and start mixing right away. Please read the rest of this guide before connecting to your amplifier and speaker systems.

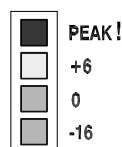
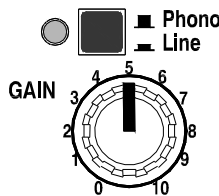
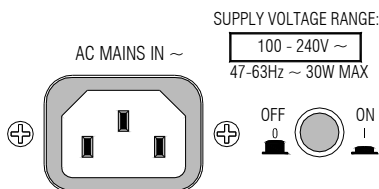
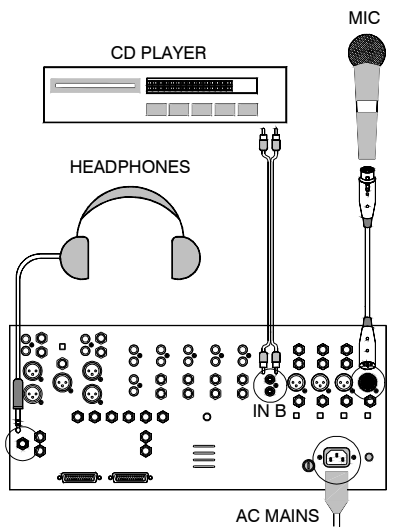

Set all controls to their starting condition. Set all FADERS, GAIN, AUX, EXT IN, VCF, RESONANCE, PHONES and MONITOR controls minimum. Set all PAN and EQ controls to their detented centre position. Set all switches to their up position.

Plug in a microphone. Plug a microphone into CH1 XLR input using a high grade balanced mic cable. We recommend you use a professional standard low impedance balanced dynamic microphone, such as used for live performance vocals. Do not use inferior high impedance or unbalanced microphones as these can degrade the sound.

Plug in a CD player. This provides a good stereo audio source as a starting point. Plug into CH5 Input B. Do not use Input A as this is intended for turntables with magnetic cartridges requiring RIAA equalisation.

Plug in the headphones. You can plug into either the top panel or the rear panel socket. Two pairs can be plugged in at the same time. Use the best headphones you can afford for your application. We recommend the professional grade closed-ear type of 30 to 600ohms impedance, and with 1/4" TRS jack plug. Avoid using the popular mini jack to 1/4" adapters as these can quickly prove unreliable.

Connect AC mains power. Check first that the correct mains lead with sealed plug suitable for your local supply has been provided with your console. Plug into the IEC AC MAINS IN socket and switch mains on.

Switch the console on. Press the rear panel ON/OFF switch. Check that the green POWER ON led at the top of the panel lights. You may notice that the console meters flash briefly. This is normal during power up.

Always switch connected amplifiers on last and off first to avoid power on/off thumps.

Select the stereo source. Start with the CH5 CD source. Press the PHONO/LINE switch to select Input B. The led should glow red when you select Input B, green for Input A.

Adjust the channel gain. Start the CD player. Adjust CH5 GAIN control until the average music level lights the green 0 led with loudest peaks lighting the yellow +6 led. Reduce GAIN if the red PEAK! Led lights. If no signal is present check that the music source is playing and the correct input is selected.

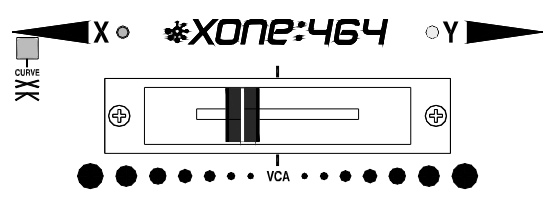
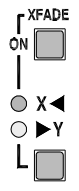
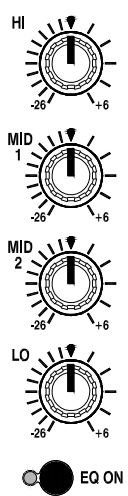
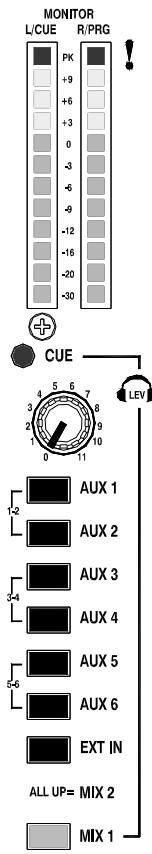

Check the sound using the Cue system. With the music playing press the large CUE switch. The switch itself and the master section CUE led light to show that the cue monitor is active. The channel signal is now sent to the headphones. Slowly turn up the headphones level control until you hear the music at comfortable volume.

⚠️ Avoid listening to loud headphones levels for long periods as this may damage your hearing.

The channel signal is now displayed on the main monitor meters giving you finer control in setting the gain. Note that the cue system lets you monitor channel signals pre-fader. In other words you can check or cue any source before you raise its fader to bring it into the mix.

Route the signal to the main Mix1 output. Release the CUE switch. The CUE led turns off and the headphones and monitor meters go quiet. Raise CH5 fader to its top '0' position. Raise MIX1 master level to maximum. With the XFADE ON switch in its up position the signal is routed direct to Mix1. The signal is now indicated on the Mix1 meters at the same level as the channel meter. The level is now the same throughout the console signal path, as set by the channel gain control. This is the ideal setting with meters averaging 0dB so giving the best signal-to-noise performance while maintaining plenty of headroom to avoid clipping.

Listen to the main Mix1 output. To hear the signal in the headphones press the MIX1 monitor select switch. Make sure the other select switches are up as these will automatically override Mix1 if pressed. Similarly any CUE switch pressed will override the monitor selection.

Check the effect of the Stereo EQ. Press CH5 EQ ON switch. This lights to show that the signal is routed through the equaliser. Now try the effect of each of the 4 frequency bands. The EQ is designed for creative live performance control and provides a safe +6dB boost and a massive -26dB cut. Experiment with cutting rather than boosting frequencies to create dramatic effects. These can be punched in or out using the EQ ON switch.

Route through the Crossfader. Press XFADE ON to route the signal through the crossfader rather than direct to Mix1. The green X led lights indicating that the channel is assigned to the left (X) side of the crossfader. Press the XY switch to assign the signal to the right (Y) side. In this case the yellow Y led lights. Note the green X and yellow Y leds above the crossfader to help you see which channel is routed to which side.

Using the Crossfader. This lets you fade between signals routed to either side, typically to fade smoothly into a new music track or to creatively layer sounds when scratch or beat mixing. Experiment further by connecting two music sources such as CD or turntables and assigning one to X, the other to Y. Use XFADE PAN to adjust the balance between the left and right signals of the active source, either to correct an imbalance or as an effect in its own right.

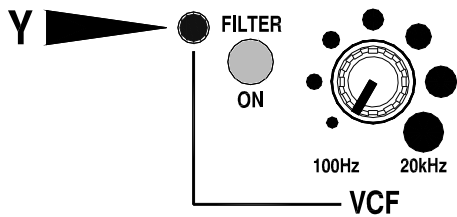

Adding VCF filter effects. Each side of the crossfader includes a stereo Voltage Controlled Filter which presents the DJ with a unique set of live performance tools to create subtle or startling tonal effects. With the signal assigned to the Y side of the crossfader, and the crossfader moved fully to the right, the music is routed to Mix1 and should be heard on the headphones. Press the Y FILTER ON switch to route the signal through the analogue filter section. The blue led lights to show that the filter is active. Check that the large LPF switch is illuminated indicating that the power up default lo-pass filter type is active. The sound should change to a rumbling bass line with higher frequencies removed.

Sweep the filter frequency. Turn the VCF control clockwise and you should progressively hear higher audio frequencies returning to the mix. This control sweeps the effect from low to high frequency.

Adjust the filter resonance. Slowly turn the RESONANCE control clockwise as you sweep the frequency and you should hear the 'Q' or 'sharpness' of the effect changing from subtle to drastic as the roll-off knee sharpens and frequency boost is added.

▲ Increasing resonance boosts a narrow band of selected frequencies. Make sure you reduce the channel gain if the red peak meters start to flash.

Change the filter type. Press one or any combination of the large HPF, BPF and LPF filter type switches to experiment with different performance effects. For example pressing HPF and LPF together produces a notch effect. Once you are familiar with the creative power of these filters you can apply them to your performance. More information is available later.

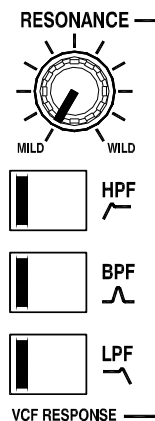

Experiment with the microphone source. Finish off by trying a microphone channel. Stop the CD and pull CH5 fader down. Next, press CH1 CUE and talk into the mic. Gradually increase the mic GAIN control until the monitor meters read an average 0dB for normal vocal level. You should also hear yourself through the headphones.

Check the effect of the 100Hz lo-cut filter. Press this switch to remove low frequencies below 100Hz. It is standard practice to switch this in when working with vocal mics as this effectively removes the proximity 'popping' effect when close miking.

Check the effect of the mic EQ. Experiment with the EQ to learn what effect these controls have on the sound. Unlike the stereo channel EQ, this is intended for 'corrective' equalisation such as smoothing out poor mic response, brightening up the sound to make it more intelligible, or dealing with problem feedback frequencies. It is not usual to use this EQ as a live effect as you would the stereo channel. It is good practice to start with the controls flat and use only as much EQ as is really needed, cutting rather than boosting frequencies.

Now... continue to read through the rest of this User Guide.

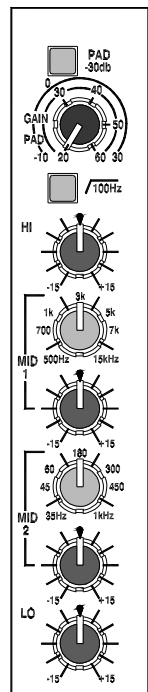

Installing the Console

The **XONE** Series features the Allen & Heath Quick Change Connector (QCC) system. The rear connector pod may be hinged and locked into either of two positions. Rear connectors allow desktop operation with the control panel sloped at a convenient 15 degrees. Underside connectors allow 19" rack mounting in a compact 10U space. The connector position can be easily changed at any time to fit your application.

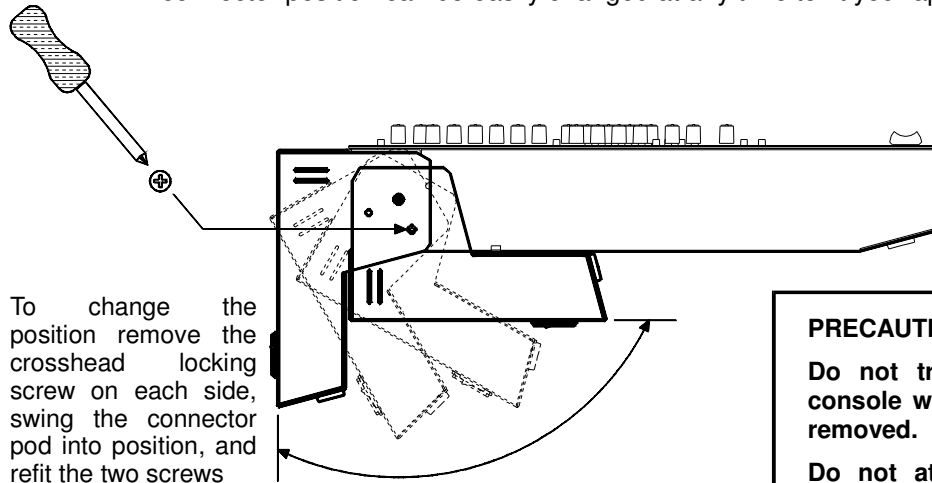

To change the position remove the crosshead locking screw on each side, swing the connector pod into position, and refit the two screws

PRECAUTION :

Do not transport or carry the console with the locking screws removed.

Do not attempt to remove the connector pod from the console.

19" Rack or Plinth Mounting

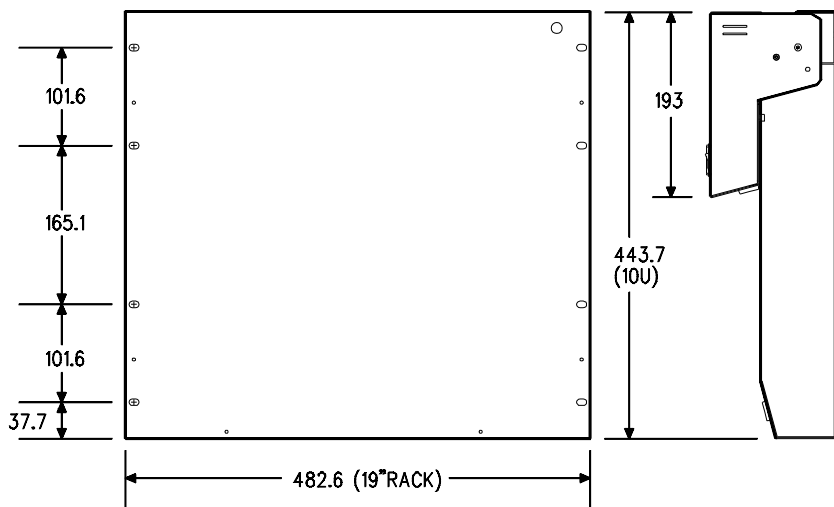

Mount the console in the rack using 4x M6 bolts each side for maximum strength. We recommend you fit the bolts with plastic cup washers to protect the panel, and they look good... These should be available from the supplier of the rack unit or good hardware store.

Flightcasing

The console can be easily flightcased in either connector mode. Provide the dimensions shown here to your flightcase supplier.

Desktop Operation

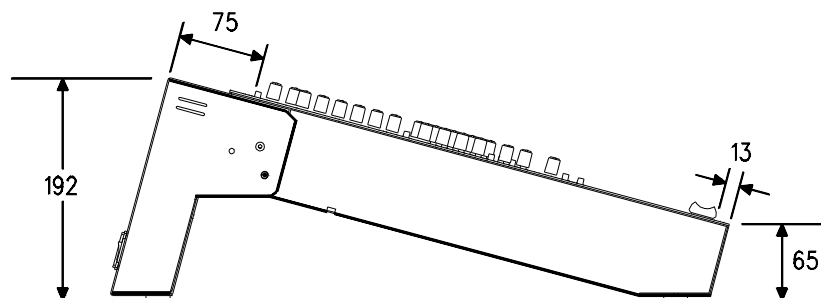

The console is fitted with rubber feet to ensure it does not slip or scratch the work surface. The control panel is angled at 15 degrees for operating convenience.

Connecting Mains Power

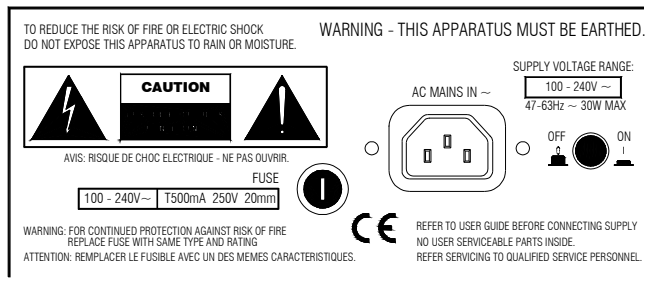

Read the **SAFETY INSTRUCTIONS** printed at the front of this User Guide. Check that the correct mains lead with moulded plug has been supplied with your console. The power supply accommodates mains voltages within the range 100-240V without changing any fuses or settings.

It is standard practice to turn connected power amplifiers down or off before switching the console on or off. Ensure that the IEC mains plug is pressed fully into the rear panel socket before switching on.

Earthing



The connection to earth (ground) in an audio system is important for two reasons:

1. **SAFETY** - To protect the operator from high voltage shock, and
2. **AUDIO PERFORMANCE** - To minimise the effect of earth (ground) loops which result in audible hum and buzz, and to shield the audio signals from interference.

For safety it is important that all equipment earths are connected to mains earth so that exposed metal parts are prevented from carrying high voltage which can injure or even kill the operator. It is recommended that the sound engineer check the continuity of the safety earth from all points in the system including microphone bodies, turntable chassis, guitar strings, connector cases, equipment panels and so on.

The same earth is also used to shield audio cables from external interference such as the hum fields associated with power transformers, lighting dimmer buzz, and computer radiation. Problems arise when the signal sees more than one path to mains earth. An 'earth loop' (ground loop) results causing current to flow between the different earth paths. This condition is usually detected as a mains frequency audible hum or buzz.

To ensure safe and trouble-free operation we recommend the following:

- **Have your mains system checked by a qualified electrician.** If the supply earthing is solid to start with you are less likely to experience problems.
- **Do not remove the earth connection from the console mains plug.** The console chassis is connected to mains earth through the power cable to ensure your safety. Audio 0V is connected to the console chassis internally. If problems are encountered with earth loops operate the audio 'ground lift' switches on connected equipment accordingly, or disconnect the cable screens at one end, usually at the destination.
- **Make sure that turntables are correctly earthed.** A chassis earth terminal is provided on the console rear panel to connect to turntable earth straps.
- **Use low impedance sources** such as microphones and line level equipment rated at 200 ohms or less to reduce susceptibility to interference. The console outputs are designed to operate at very low impedance to minimise interference problems.
- **Use balanced connections where possible** as these provide further immunity by cancelling out interference that may be picked up on long cable runs. To connect an unbalanced source to a balanced console input, link the cold input (XLR pin 3 or jack ring) to 0V earth (XLR pin 1 or jack sleeve) at the console. To connect a balanced XLR output to unbalanced equipment, link the cold output to 0V earth at the console.
- **Use good quality cables and connectors** and check for correct wiring and reliable solder joints. Allow sufficient cable loop to prevent damage through stretching.
- **If you are not sure ...** Contact your service or local Allen & Heath agent for advice.

Plugging Up The System

The **XONE:464** uses professional grade 3 pin XLR, 1/4" TRS jack and RCA PHONO sockets. To ensure best performance, we recommend that you use high quality audio cables and connectors, and take time to check for reliable and accurate cable assembly. It is well known that most audio system failures are due to faulty interconnecting leads. The following mating plugs may be used to connect audio signals to the console:

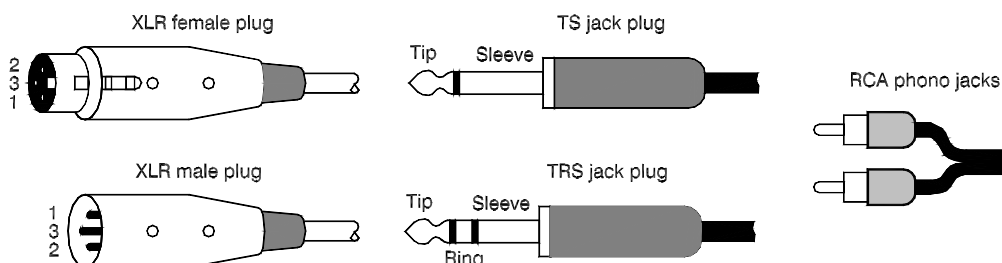

All input and output **XLR** connectors are 3 wire differentially balanced. These have 3 connector pins: Pin 1 = ground (screen), Pin 2 = signal hot (+), Pin 3 = signal cold (-).

All the jack sockets are the 3 pole **TRS** type. These are wired to work with both the balanced TRS or the unbalanced 2 pole TS type plugs. The sockets have 3 connector pins: Inputs and outputs are Tip = signal hot (+), Ring = signal cold (-), Sleeve = ground (screen). Insert connections are Tip = send, Ring = return, Sleeve = ground.

The **RCA** phono connectors are the 2 wire unbalanced type typical of those found on equipment such as CD players, turntables and domestic amplifiers.

Avoid reversing + and - on balanced connections as this will result in out of phase signals (reverse polarity) which may cause signal cancellation effects.

For live work where long cables runs are required, balanced interconnections should be used. However, interconnections between more affordable 2-wire (signal, ground) unbalanced equipment and the console are unlikely to cause problems if the cables are kept short. Refer to the following diagram for unbalanced to balanced connections.

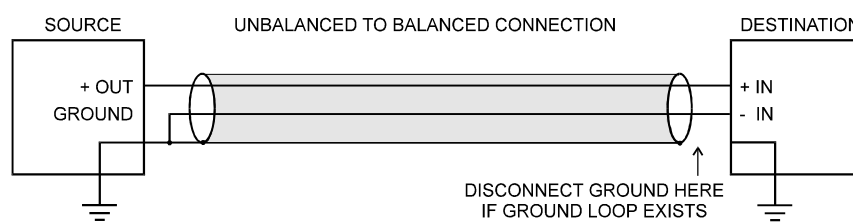

Dealing with Ground Loops, Buzz and Interference

For optimum performance all audio signals should be referenced to a solid, noise-free ground (earth) point, frequently referred to as the 'star point' or 'clean earth'.

A ground loop is created when the signal has more than one path to ground. Should you experience hum or buzz caused by ground loops, check first that each piece of equipment has its own separate path to ground. If so, operate ground lift switches on connected equipment in accordance with the instruction manuals. Alternatively disconnect the cable screen at the destination end only. This breaks the offending loop while still maintaining the screening down the length of the cable.

▲ WARNING For your safety do not remove the earth (ground) connection in the power lead of the console or connected equipment.

To avoid interference pickup keep audio cables away from mains power units and cables, thyristor dimmer units or computer equipment. Where this cannot be avoided, cross the cables at right angles to minimise interference.

Connecting the Mono Channel

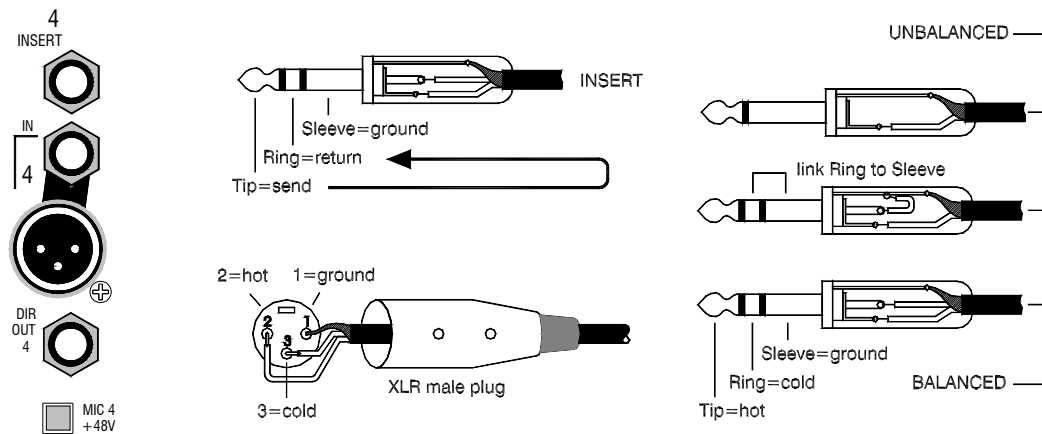

INPUT The input provides both an XLR and a TRS jack connector. The XLR is normalled through the jack connector. This means that plugging in a jack overrides the XLR source. Plug a microphone into the XLR socket leaving the jack unplugged. Plug a line level source into the jack socket and select the front panel PAD switch. For line level sources on XLR plug into the XLR leaving the jack unplugged and select PAD. This feature lets you connect a wide 70dB range of mic or line sources on either XLR or jack.

Both XLR and jack inputs are 3 wire balanced. This prevents interference pickup on long cable runs when connecting to balanced sources such as microphones. To connect an unbalanced XLR source link Pin 3 to Pin 1 in the XLR plug. The jack input automatically grounds the cold (-) input to accept unbalanced TS (mono) jack sources. To connect an unbalanced source using a TRS (stereo) jack you should link ring to sleeve in the plug as shown above. Do not select +48V phantom power when connecting unbalanced sources.

MIC +48V Press this tamperproof underpanel switch when connecting to microphones such as condenser types which require phantom power. This provides +48V DC to pins 2 and 3 of the XLR.

WARNING Do not connect unbalanced sources or cables to the XLR inputs when phantom power is selected. Use +48V only with balanced microphones which require powering. Note that harm will not be done to non powered microphones as long as they are balanced. To avoid loud clicks always turn the channel off by releasing the ON switch when switching +48V on or off and when plugging or unplugging microphones with power applied.

INSERT You do not need to plug anything into the insert socket for normal operation. It is a break point that lets you plug in an external signal processor such as a compressor or noise gate if required. Plugging in a jack breaks the signal path after the input pre-amp and before the EQ. The signal is unbalanced and operates at a nominal 0dBu line level. Use a TRS jack wired as shown above to connect the SEND to the processor input and the RETURN from the processor output. The sleeve provides the common ground for cable screening. Use a TRS Y-adapter and two standard jack leads or wire two leads to a TRS plug. If required you can tap off the send to provide an alternative pre-EQ direct output by plugging in a lead with tip and ring shorted together so that the channel signal path is not interrupted.

DIR OUT This provides a post-fader direct output for connection to external processing or recording equipment. This can be set to pre-fader by changing an internal link option. The output operates at 0dBu and is impedance balanced on TRS jack to provide the benefit of interference rejection when connecting to equipment with balanced inputs. You can also connect to unbalanced equipment as shown above.

Connecting the Stereo Channel

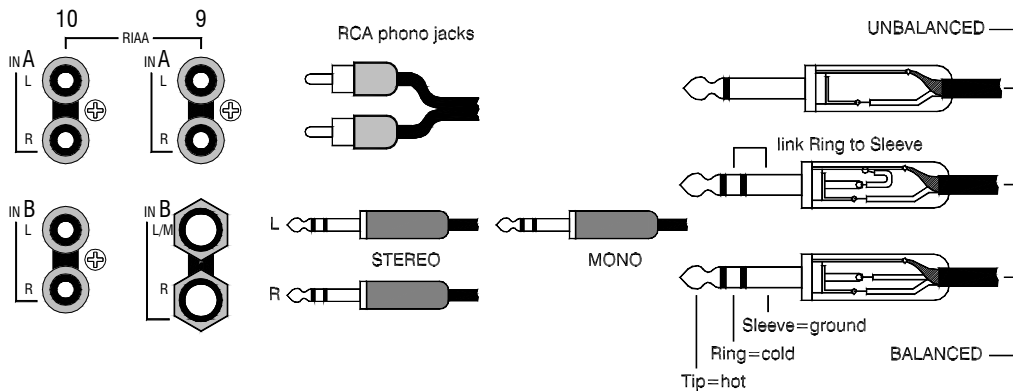

INPUT A This provides a pair of RCA phono sockets for connection to stereo sources. Channels 5,6,9,and 10 provide RIIA equalisation for magnetic cartridges to connect up to 4 turntables (record decks). Make sure the turntables are correctly earthed by connecting their earth straps to the console chassis earth terminal. Channels 7 and 8 inputs are unbalanced and can accept line levels signals from as low as -10dBu to a high $+10\text{dBu}$ for to connect stereo equipment such as CD and MiniDisc players. The level is matched to the console using the front panel GAIN control.

INPUT B This provides either a pair of TRS jack or RCA phono sockets for connection to line sources. Channels 5 and 10 provide RCA phono sockets for connection to stereo sources. Channels 6,7,8 and 9 provide TRS jack sockets. For stereo sources plug into both the L/M and R sockets. For mono sources plug into just the L/M socket leaving the R socket unplugged. In this case the signal is normalled through the R socket to the right channel. The jack inputs are balanced to provide interference rejection when connecting to 3 wire balanced sources using long cables. The socket automatically grounds the cold (-) input to accept unbalanced 2 wire TS jack sources. To connect an unbalanced source using a TRS jack you should link ring to sleeve in the plug as shown above. The inputs can accept line level signals from as low as -20dBu to a high $+10\text{dBu}$. The level is matched to the console using the front panel GAIN control.

Connecting the External Input

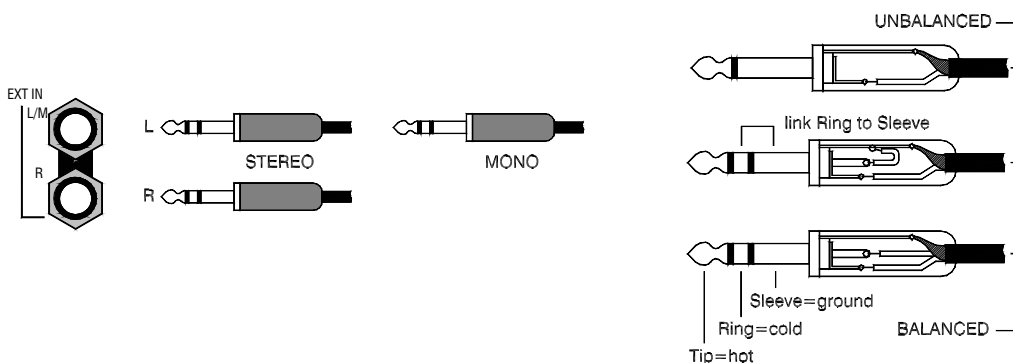

EXT IN This provides a pair of TRS jack sockets for connection to line level sources such as effects, 2-track or monitor returns. Tamperproof front panel switches determine whether the signal feeds Mix1, Mix2 or both, or just the monitor select switch bank. For stereo sources plug into both the L/M and R sockets. For mono sources plug into just the L socket leaving the R socket unplugged. In this case the signal is normalled through the R socket to the right channel. The inputs are balanced to provide interference rejection when connecting to 3 wire balanced sources using long cables. The socket automatically grounds the cold (-) input to accept unbalanced 2 wire TS jack sources. To connect an unbalanced source using a TRS jack you should link ring to sleeve in the plug as shown above. The operating level is -10dBV but may be set for $+4\text{dBu}$ by changing an internal link option.

Connecting Mix1 and Mix2 Outputs

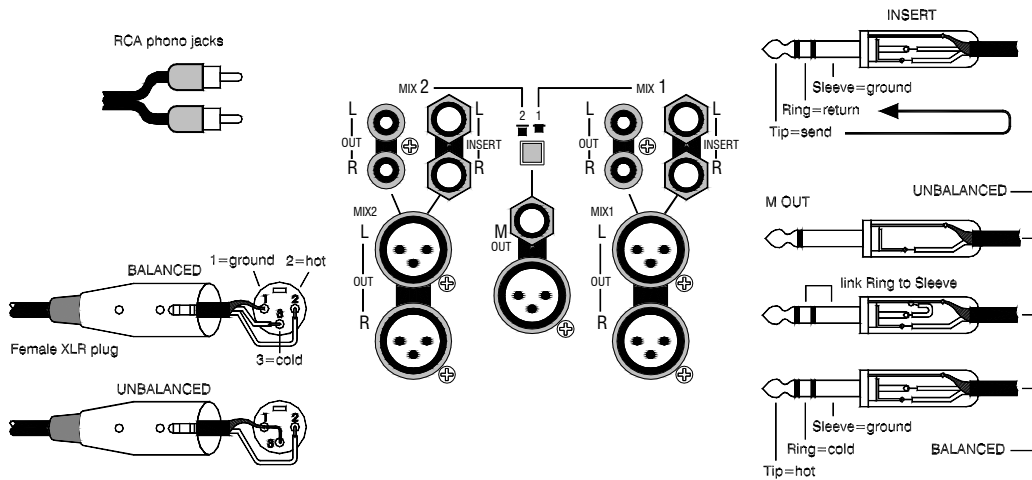

INSERT Both MIX1 and MIX2 provide insert points for left and right channels. You do not need to plug anything into the insert socket for normal operation. It is a break point that lets you plug in an external signal processor such as a limiter or equaliser if required. Plugging in a jack breaks the signal path after the buss mix amp and before the master fader. The signal is unbalanced and operates at a nominal -2dBu line level. Use a TRS jack wired as shown above to connect the SEND to the processor input and the RETURN from the processor output. The sleeve provides the common ground for cable screening. Use a TRS Y-adapter and two standard jack leads or wire two leads to a TRS plug.

L,R XLR OUTPUTS The Mix1 and Mix2 main left and right outputs are on balanced XLR connectors. 3 Pin female XLR plugs are required to connect to these. Connect to balanced equipment for maximum interference rejection on long cable runs. To connect to unbalanced equipment link Pin 3 to Pin 1 in the XLR plug as shown. Alternatively use the unbalanced RCA phono outputs. Signal level is a nominal $+4\text{dBu}$ (0 on the meters). These outputs typically feed the main amplifier/speaker systems or stereo DJ to large FOH console. Mix1 can feed Mix2 by pressing a tamperproof front panel switch. Typically this could provide a music only zone or clean feed.

L,R RCA OUTPUTS These are intended for connection to recorders but can be used as additional zone feeds, or as an alternative to the XLR outputs, for example when connecting to domestic hi-fi amplifiers.

M XLR OUTPUT This provides a sum of the post-fader left and right signals. Use the rear panel switch to select either Mix1 or Mix2 as the source. The output is balanced XLR operating at a nominal $+4\text{dBu}$. Connect to balanced or unbalanced equipment as described above for the L R outputs. Typical uses include feeding mono speaker, submix, centre fill, sub bass, mono zone, sound to light and recording systems.

Connecting Auxiliary Outputs



AUX 1-6 OUTPUTS Each of the six auxiliary sends is available on a 3 pole TRS jack socket. These are impedance balanced to reduce noise pickup on long cable runs. Connect to balanced or unbalanced equipment as shown above. Nominal operating level is -2dBu but gain is available using the send master control to drive $+4\text{dBu}$ if required. Use pre-fade auxes to feed stage monitor, foldback and cue systems. Use post-fade auxes to feed effects processors such as reverb, and to provide independent zone, cleanfeed and recording feeds.

Connecting the Headphones and Local Monitor

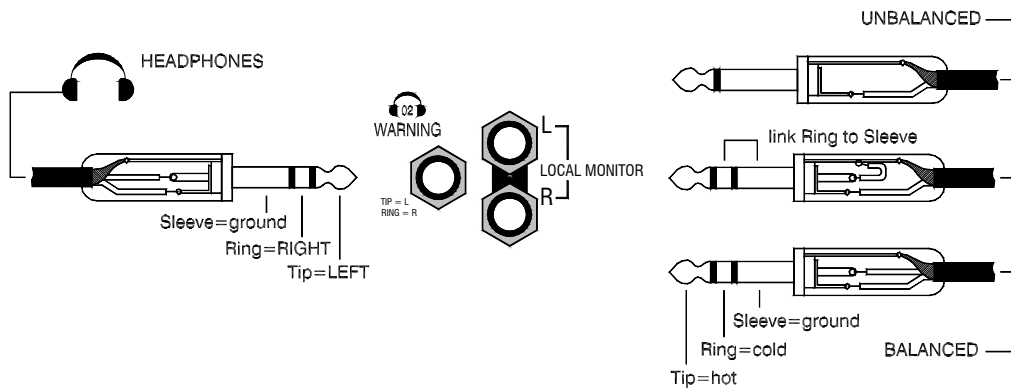

LOCAL (BOOTH) MONITOR OUTPUTS A pair of 3 pole TRS jack sockets provide left and right outputs from the console local monitor system. These are impedance balanced and can be connected to balanced or unbalanced equipment as shown above. Nominal operating level is -2dBu but gain is available to drive $+4\text{dBu}$ if required. Independent control is provided for the local and the headphones monitor systems. This output typically feeds the DJ booth monitor with the music only mix, and Cue if required.

HEADPHONES 2 OUTPUT Two outputs are available for stereo headphones, one on the front panel, the other on the rear panel. This is convenient for permanent installation or when two headphones are required at the same time, for example presenter and guest in a broadcast application. The same signal is available from both. Headphones are available in many different styles, impedances and volume ratings. To get the best from your system we recommend that you use high quality closed ear headphones in the range 30 to 600 ohms. 8 Ohm headphones are not recommended.

WARNING Some headphones are more sensitive than others and can produce higher output levels. To avoid damage to your hearing start with the PHONES level control at minimum and turn up only as much as is needed to maintain comfortable listening level. Do not drive headphones at high listening levels for long periods of time.

User Connector Options

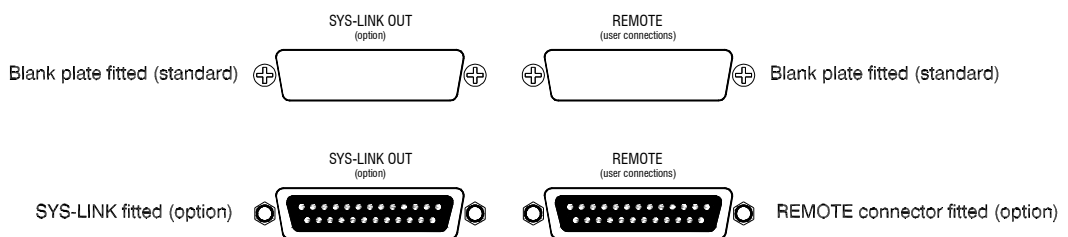

SYS-LINK OUTPUT The console is supplied with a blank plate fitted here. An optional kit of parts is available to install a 25 pin D-connector and circuit card which provides all console outputs on a single connector. This is convenient when connecting the **XONE:464** as an expander to another console. Use a standard 25 pin one-to-one shielded cable to plug this output into any Allen & Heath console fitted with SYS-LINK input. Alternatively wire a custom cable as required. SYS-LINK operates unbalanced at -2dBu and is not intended for long cable runs. Note that SYS-LINK input is not available on the **XONE:464**. Contact your Allen & Heath agent for further details.

USER CONNECTOR The console is supplied with a blank plate fitted here. A 25 pin D-connector may be installed and custom wired to satisfy the particular requirements of the application. The installation of this connector should be carried out only by qualified personnel. Contact your agent for further details.

Mono Input Channel

PAD Affects both the XLR (if no TRS jack is plugged in) and the TRS jack input to attenuate the input signal by 30dB. Press PAD when plugging in line level sources, or when the signal is too high with the GAIN control turned down.

GAIN Adjusts the input sensitivity to match the connected source to the console 0dB operating level. This provides a wide 70dB range with continuous adjustment for signals from -60dBu to -20dBu with PAD switched off, and -30dBu to $+10\text{dBu}$ with PAD on. Use the Cue system to correctly set the gain using the console meters.

100HZ FILTER Switches in the high pass filter to cut frequencies below 100Hz with a slope of 12dB/octave. Use this to clean up vocals by reducing microphone proximity popping and low frequency ambient pickup, and to filter out hum and rumble. The filter is post-insert and pre-EQ so that it affects the signal returned from any inserted equipment by removing the unwanted low frequencies before equalisation.

EQUALISER The channel equaliser is a powerful tool to creatively tailor the sound within the mix, or to deal with source problems such as poor microphone characteristics, noise and feedback. Start with the EQ controls set to their mid (flat) position and make sure you have chosen the best type and position of microphone for the source. Then adjust the EQ to achieve the sound you want. Take time to experiment with the controls so you get to learn the effect the equaliser can have on the sound.

The **XONE:464** mono channel provides separate tone control over four frequency bands including two swept frequency (parametric) mids. The frequencies in each band may be boosted or cut by up to 15dB. The centre flat position is detented for quick resetting.

HI Turn this control clockwise to boost and anticlockwise to cut the high (treble) frequencies. This has a shelving response with all frequencies above the 12kHz turning point affected. Note that frequencies below 12kHz are affected by a decreasing amount. Use HI boost to brighten up the sound by adding sparkle, and cut to reduce source hiss or ambient high frequency pickup.

MID 1 Turn the +/- control clockwise to boost and anticlockwise to cut the higher mid frequencies. This has a bell shaped peak/dip response that has maximum boost or cut at the selected frequency. Use the upper control to select this centre frequency between 500Hz and 15kHz. Boosting around 3kHz can enhance the intelligibility of vocals helping them to cut through the mix. Cutting to notch out a ringing frequency can help to increase the gain before feedback.

MID 2 This is similar to MID 1 but affects the lower mid frequencies selectable from 35Hz to 1kHz. Boosting can enhance the warmth of the sound while cutting can reduce the effect of resonant or boomy frequencies.

LO Turn this control clockwise to boost and anticlockwise to cut the low (bass) frequencies. This has a shelving response with all frequencies below the 60Hz turning point affected. Note that frequencies above 60Hz are affected but by a decreasing amount. Use LO boost to enhance low end punch, and cut to further reduce source hum and rumble.

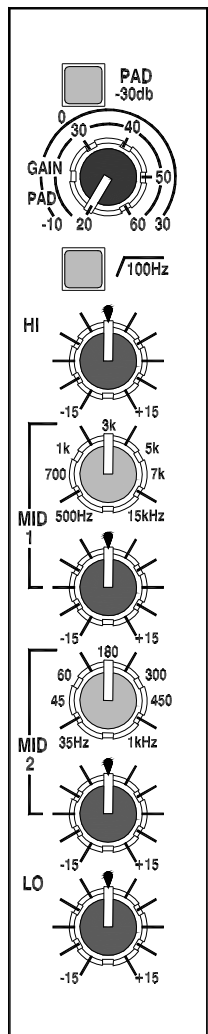

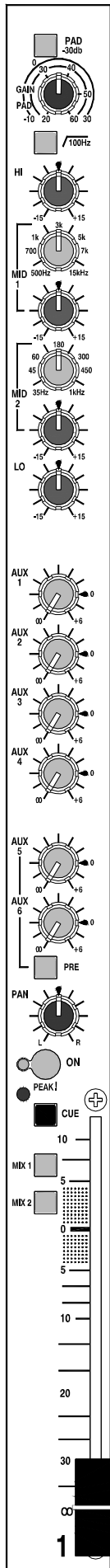

AUXILIARY SENDS These controls route the channel signal to the AUX 1 to 6 mix. These are independent from the main mix and can therefore provide additional outputs for monitors, effects, cleanfeed, zone, recording feeds etc.

AUX LEVEL Adjusts the level of the channel signal in each mix. Turn fully anticlockwise to turn the signal off, fully clockwise for a maximum +6dB boost. The normal '0' position is marked. Each of the 6 aux mixes has its own dedicated channel level control. Note that Auxes 3-4 and 5-6 are fed as a stereo pair from the stereo channels. Adjust the two related level controls when feeding the mono channel to a stereo aux.

PRE/POST Auxes 1-4 are always pre-fade. Aux 5-6 can be switched pre or post-fade. With the switch in the up position the post-fader channel signal is routed. Press the switch to select the pre-fader signal instead.

Set the switch to POST to send to external effects devices such as reverb processors. The amount of signal sent to the device follows the fader level. The processed (wet) signal returned to the mix elsewhere is therefore in proportion to the direct (dry) routed signal regardless of fader position. Post-fade sends are also used to provide zone or recording feeds where the outputs should follow the fader movements.

Set the switch to PRE to send to monitors such as stage or remote foldback or recording cue. The amount of signal in the monitor mix is independent of the fader movements. therefore adjustments made to the main mix will not affect the balance of the monitors. Note that selected channels in a monitor mix can still be set post-fader if required, for example to prevent 'dressing room' talk when working with radio microphones. The pre-fade sends are set post-EQ post-ON as standard. These can be reconfigured pre-EQ and/or pre-ON by resoldering internal links.

PAN Positions the channel signal between left and right in the stereo mix to create the required image. The centre (mono) position is detented for quick resetting.

ON Turns the channel signal on or off. The green LED lights when the channel is turned on. All outputs except the insert send and Cue are muted when the channel is turned off. Note that the pre-fade aux sends can be internally reconfigured so that they are not affected by this switch if required.

PEAK The red LED lights when the channel is within 9dB of clipping. This warns that you should turn back the GAIN control to reduce the signal level.

CUE Press CUE to listen to the pre-fader channel signal using the headphones or local monitor (if enabled). This does not affect the main outputs and lets you audition the signal before you raise the fader and introduce it into the mix. The signal level is also displayed on the console monitor meters so that GAIN can be set to achieve the correct operating levels. The PEAK LED half lights to show which channel PFL has been selected.

MIX1 (2) Routes the post-PAN channel signal to Mix1 and Mix2. None, one or both may be selected.

FADER A 100mm long throw fader adjusts the level of the channel signal and provides a clear visual indication of its contribution to the mix. It does not affect the pre-fader AUX sends. It does affect DIR OUT unless it has been reconfigured pre-fader. The '0' mark indicates normal operating position. The fader can be set above or below this depending on the balance required in the mix. A further 10dB of boost is available at the top of its travel. Use the Cue system to check that the channel gain is correctly set before raising the fader to add the channel to the mix.

Stereo Input Channel

AUXILIARY SENDS This section is positioned at the top of the stereo channel to be out of the way of the live performance controls. The controls route the stereo channel signal to the AUX 1 to 6 mix. These are independent from the main mix and can therefore provide additional outputs for monitors, effects, cleanfeed, zone, recording feeds etc.

AUX LEVEL Adjusts the level of the channel signal in each mix. Turn fully anticlockwise to turn the signal off, fully clockwise for a maximum +6dB boost. The normal '0' position is marked. Aux 1 and 2 are independent mono mixes fed from the sum of the left and right channel signals. Aux 3-4 and Aux 5-6 are stereo pairs with left signal feeding odd, and right feeding even outputs.

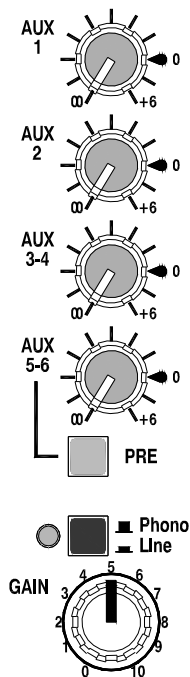

PRE/POST Auxes 1, 2 and 3-4 are always pre-fade. Aux 5-6 is post-fade but can be switched pre-fade. With the switch in the up position the post-fader channel signal is routed. Press the switch to select the pre-fader signal instead.

Set the switch to POST to send to external effects devices such as reverb processors. The amount of signal sent to the device follows the fader level. The processed (wet) signal returned to the mix elsewhere is therefore in proportion to the direct (dry) routed signal regardless of fader position. Post-fade sends are also used to provide zone or recording feeds where the outputs should follow the fader movements. Note that the post-fade sends do not follow the crossfader setting. Use the XFADE Aux sends instead if the level should be affected by the crossfader.

Set the switch to PRE to send to monitors such as stage or remote foldback or recording cue. The amount of signal in the monitor mix is independent of the fader movements. That means that adjustments made to the main mix will not affect the balance of the monitors. Note that selected channels in an Aux 5-6 monitor mix can still be set post-fader if required, for example to prevent 'dressing room' talk when working with radio microphones. The pre-fade sends are set post-EQ post-ON as standard. These can be reconfigured pre-EQ and/or pre-ON by resoldering internal links.

INPUT SELECT The channel accepts two stereo sources, Input A and Input B. In the up position Input A (Phono) is selected. Press the switch to select Input B (Line). The two colour indicator glows green for Input A, red for Input B.

Input A provides RCA phono sockets. CH 5,6,9,10 have RIAA (Record Industry of America Association) equalisation for connection to high quality magnetic cartridge turntables (phonograph). Only connect turntables to these inputs. The middle channels CH 7 and 8 are standard line level inputs for CD, MiniDisc, DAT, hard disk players and so on.

Input B accepts standard line level equipment. CH 5 and 10 provide RCA phono sockets for unbalanced connection. CH 6,7,8, and 9 provide TRS 1/4" jacks ideal for balanced or unbalanced connection to professional players, effects processors and stereo instruments.

GAIN Adjusts the input sensitivity to match the connected source to the console 0dB operating level. This provides a 20dB range with continuous adjustment for line level signals from -10 to +10dBu or to match RIAA cartridges. Use the channel meter and Cue system to correctly set the gain.

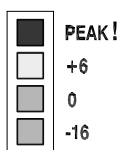

Reduce GAIN if the channel PEAK! Or main meter PK leds flash.

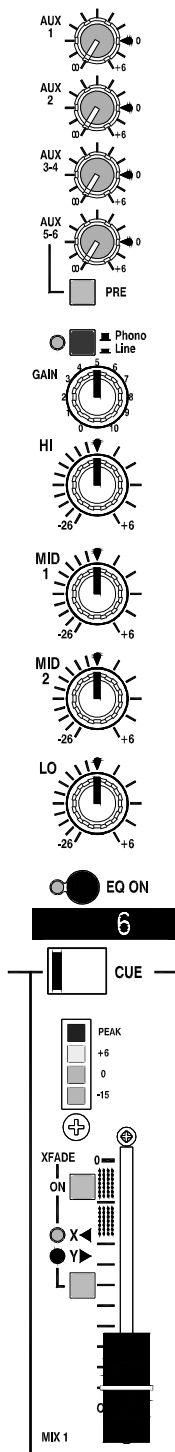

EQUALISER The EQ on a DJ mixer provides a very different function to that on any other mixing console. As most music sources are pre-recorded corrective EQ as found on the microphone channels is not required. Instead, the EQ is used by the DJ to creatively shape the sound during live performance. It is important that a wide range of control is available without danger of signal overload during over-zealous performance.

The **XONE:464** stereo equaliser is a unique 4 band asymmetric design. It is known as 'asymmetric' because the amount of boost and cut is not the same. Boost is restricted to a safe +6dB to highlight selected sounds while preventing signal overload and resultant distortion. Cut is increased to a massive -26dB which completely sucks out the affected frequencies dramatically changing the effect of the sound. This is almost twice as much cut as found on conventional mixers.

Large, clearly spaced, soft touch knobs are provided for these important performance controls. They are centre detented so that the middle 'flat' position can be quickly found.

HI Turn this control clockwise to boost and anticlockwise to cut the high (treble) frequencies. This has a shelving response with all frequencies above the 10kHz turning point affected. Note that frequencies below 10kHz are affected by a decreasing amount. Use HI to highlight or remove sounds such as cymbals or strings, or add sparkle to vocals.

MID 1 This has a bell shaped peak/dip response that affects the mid frequencies centred around 1kHz. It is most effective in highlighting or removing the intelligibility of vocals, lead synth, the warmth of strings and so on.

MID 2 This is similar to MID 1 but affects the lower mid frequencies centred around 250Hz. It can drastically alter the 'texture' of the bass sound. Boost gives a hard edge to bass frequencies, useful for Techno style music. Cut gives a soft deep Dub sound bass, great for Garage or Drum and Bass. Cutting HI, MID 1 and MID 2 together leaves just the bass line.

LO Turn this control clockwise to boost and anticlockwise to cut the low (bass) frequencies. This has a shelving response with all frequencies below the 100Hz turning point affected. Note that frequencies above 100Hz are affected but by a decreasing amount. Use LO boost to enhance low end punch, and cut to completely remove all low bass. Use with MID 2 to alter the bass sound of a track.

EQ ON Press to route the signal through the stereo equaliser. The switch cap illuminates to show EQ active. This provides a useful performance tool to punch an EQ effect in or out.

CUE Press the large CUE switch to listen to the pre-fader channel signal using the headphones or local monitor. This does not affect the main outputs and lets you audition the signal to cue a track before you raise the fader and introduce it into the mix. The signal level is also displayed on the console monitor meters so that GAIN can be accurately set to achieve the correct operating levels. The switch cap illuminates so that you can see at a glance which channel is cued.

METER A 4 led meter bar always shows the presence of pre-fader signal on the stereo channel. Adjust the GAIN control for normal music levels averaging 0dB with loudest moments reaching +6. Reduce gain if the red PEAK! Led flashes.

FADER A 60mm stereo fader adjusts the level of the channel signal and provides a clear visual indication of its contribution to the mix. It does not affect the pre-fade AUX sends. The '0' mark at the top of its travel indicates normal operating position.

Crossfader

The crossfader is the one feature that instantly sets the DJ mixer apart from a conventional mixer. It is applied to the stereo (music) channels and lets you smoothly fade from one track into another using a single fader. It is also used as a creative performance tool to layer or interact between two sounds when cut or scratch mixing. It is fully assignable and can be easily replaced if it becomes damaged or worn through exceptional mechanical operation.

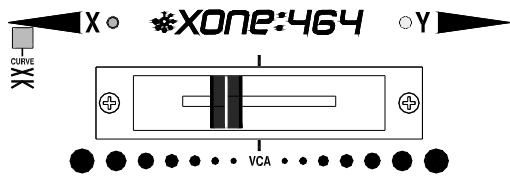

VCA CROSSFADER The **XONE:464** uses four high performance voltage controlled amplifiers (VCA), a pair for each side of the stereo crossfader. The robust 45mm fader simply produces a DC control voltage which determines the signal level of the VCAs. The voltage is filtered to prevent any audible noise, clicks or scratchiness resulting should the fader track become worn. This benefit would not be possible if the signal were routed through a conventional audio fader.

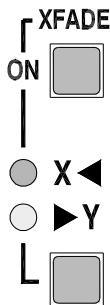

ASSIGNING A CHANNEL TO THE CROSSFADER Each of the 6 stereo channels can be routed direct to the main Mix1 or to either side of the crossfader. The output of the crossfader is routed to Mix1.

Press XFADE ON to route the stereo channel signal to the crossfader. To route to the left (X) side make sure the XY switch below is in its up position. Press XY to route to the right (Y) side. The green X led or yellow Y led light to show which side is routed. Both leds are off if the signal is not routed through the crossfader. An led above each side of the crossfader helps you visually check which channel is routed to which side.

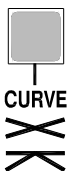

CHANGING THE CROSSFADER CURVE Using the VCA system means that the fader law (curve) can be easily changed to suit the style of mixing. Set the crossfader CURVE switch to the position required. Two standard curves are available. Experiment with both to understand their effect on the sound:

Cut Curve When the switch is pressed each signal has no attenuation in the middle position. Attenuation starts as the fader moves beyond the middle. This gives a more dramatic response better suited to cut or scratch mixing, layering different sounds, or to emphasis a mix.

Dip Curve With the switch in its normal up position each signal is attenuated by 6dB in the middle position. This means that there is no overall change in level as the two similar signals mix, ideal for seamless beat mixing when fading smoothly from one track to another.

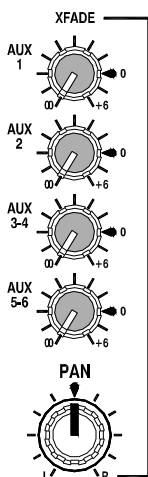

XFADE TO AUX These controls feed the Aux system with the output of the crossfader. For example, you could feed the DJ mix to the presenter (MC) stage monitor mix, send music only to mono or stereo zones, or add effects to the music mix. Aux 1 and 2 sum the left and right signals to provide two mono sends. Aux 3-4 and 5-6 are two stereo sends.

XFADE PAN Adjust PAN to change the balance between the left and right crossfader output signals. Use this to correct an imbalance in the stereo output, or as a dynamic performance effect. For normal performance make sure the PAN control is in its detented centre position.

Replacing the Crossfader

The crossfader on a DJ mixer is heavily used and can suffer considerable wear and tear. The audio design using VCAs prevents clicks and scratchiness as the fader wears. However, the movement can become mechanically stiff or sloppy in time, or become ingrained with dirt and the fader may need replacement.

The **XONE:464** crossfader is removable and can easily be replaced in a few minutes. The spare fader is supplied as a plug-in assembly which can be ordered through your Allen & Heath dealer.

Note: There are two versions of crossfader assembly. These are not interchangeable. Make sure you order the correct version.

The original model uses the Alps crossfader assembly:

XONE:464 Crossfader Assembly Part number XONE:XFADER

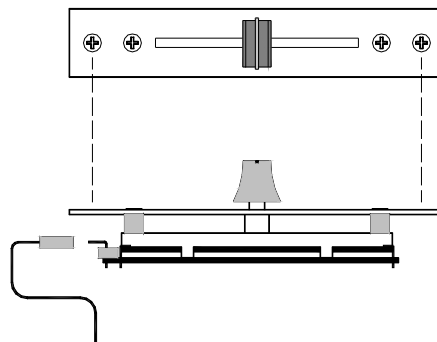

The revised model uses the Penny & Giles crossfader assembly :

XONE:464 Crossfader Assembly Part number XONE2:XFADER

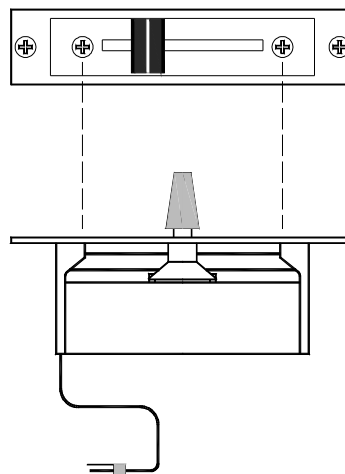

To replace either version of crossfader use a medium size cross-point (Pozidriv) screwdriver to undo and remove the two outer screws on the crossfader plate. Do not remove the inner screws.

Lift the crossfader assembly up and away from the console panel.

Unplug the cable from the old crossfader or circuit assembly (depending on version) and plug on the new assembly. Check that the connector is correctly aligned and seated.

Replace the assembly making sure the cable faces the left side of the console. Refit the screws and test for correct operation.

VCF Filters

The **XONE:464** is unique in being the first DJ mixer to include an analogue voltage controlled filter (VCF) section. These filters provide live performance tools far more powerful than any equaliser or kill switch. They produce the same warm analog resonant frequency sweeping sound as made popular by well known classic analogue synthesisers, but using the latest high performance technology for quiet, stable operation.

A **voltage controlled filter** is an audio filter whose cut-off frequency is altered by a DC control voltage rather than a variable resistor. This produces a much wider operating range and more control of the filter response to create unlimited combinations of effect.

Each X and Y side of the crossfader is provided with its own stereo VCF. Each can be switched in or out, and each has its own frequency sweep control. The filter type and resonance effect are globally selected affecting both filters simultaneously.

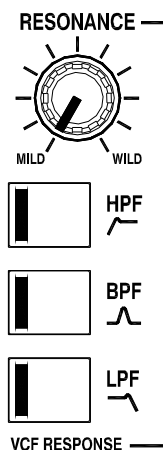

RESONANCE Adjust this to change the 'Q' or 'sharpness' of the filters. This affects how they respond around the cut-off frequency. At the minimum MILD setting the filters have a gentle roll-off 'knee' giving a subtle, smooth response. At the clockwise WILD setting they produce a resonant feedback boost around cut-off resulting in some very dramatic performance effects. The sound varies according to the filter type selected. To avoid unexpected results it is best to start experimenting with RESONANCE set to a low position.

▲ High RESONANCE settings result in significant boost of selected frequencies. Reduce the channel GAIN if the signal levels increase enough to light the red PK leds in the output meters. Failure to do this may result in system overload and distortion.

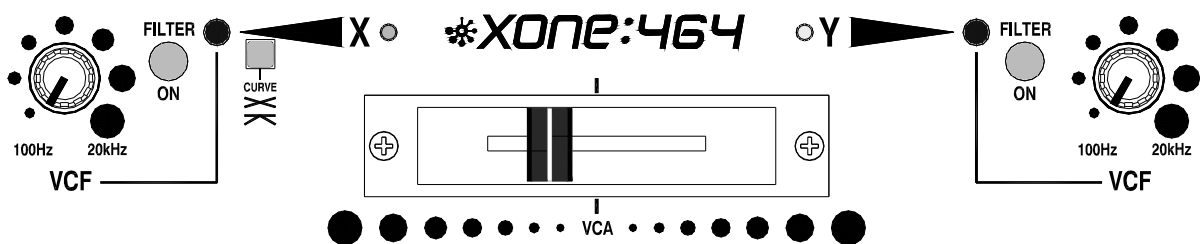

FILTER ON Each X and Y filter has its own ON switch. The blue led lights when the filter is switched on. The signal is not affected by the filter if the switch is in its off position. Use this to punch the filter effect in or out.

VCF SWEEP Each X and Y filter has its own frequency sweep control to adjust the cut-off point anywhere from low to high frequency. Rotating the control during performance produces the dynamic sweeping effects desired by performing DJs. These large controls are positioned either side of the crossfader for convenient live operation. Separate controls for X and Y mean that the effect can be applied to each track independently and faded in as the crossfader is operated.

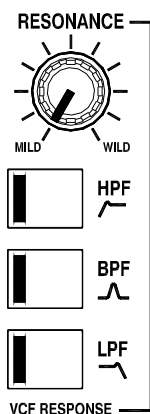

FILTER TYPE SELECT The filters are 'state variable'. This means that they provide three simultaneous filter types, high-pass, band-pass and low-pass. Three large illuminated switches select which type is active. You can press any combination together to create different response types such as 'notch' and an interesting 'all-pass' effect. The switches are 'soft switched' for live performance, meaning that the audio signal is ramped between filter states to prevent audible clicks. The selected type affects both X and Y filters.

Note that the last selected type is lost when power is removed from the console. The LPF is always selected when power is applied.

The graphs below show the effect on the audio frequency response for the three filter types. The range of sweep from low to high frequency is shown together with the effect of adjusting RESONANCE (one frequency shown).

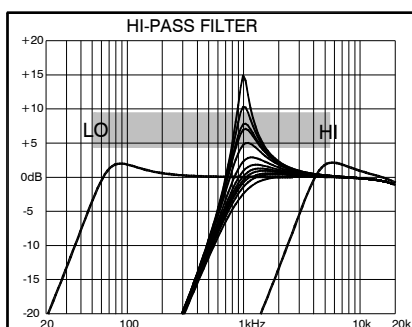

HPF Press this switch to select the high-pass filter. Frequencies below the cut-off point are removed. The cut-off point is adjusted using the large VCF control. At minimum little effect is heard as only sub bass frequencies are removed. Sweep clockwise to gradually remove the bass line followed by the higher frequencies. The highest frequency is limited to 10kHz as little useful material is heard beyond this.

Try switching the HPF in with VCF set fully clockwise at highest frequency, then sweeping the frequency back to minimum. This can create an atmosphere of anticipation as the dance floor awaits the power of the beat to kick in.

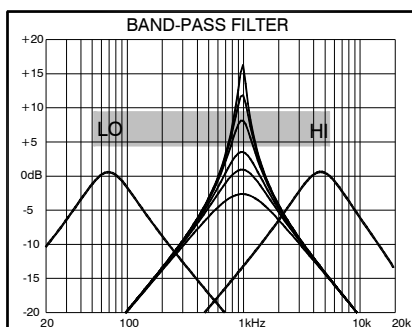

BPF Press this switch to select the band-pass filter. Frequencies above and below the cut-off point are removed leaving just a narrow band of sound. Sweep VCF around its mid position to affect lead sounds such as keyboard and vocals.

Try picking out individual sounds such as vocals and mixing them into the beat and bass of the opposite track to create a whole new mix. Add a little resonance to the BPF to lift the sound out of the mix.

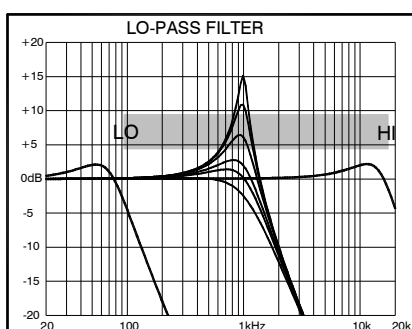

LPF Press this switch to select the low-pass filter. Frequencies above the cut-off point are removed. The cut-off point is adjusted using the VCF control. At minimum only sub bass remains. Sweep clockwise to gradually introduce the bass line followed by higher frequencies into the mix.

Try sweeping the LPF back to a low setting to keep the beat and energy going while talking over the mix. Try also punching in the filter and sweeping it back from high to low in time with the beat. Punch it out at the beginning of the next bar.

In addition to the three basic filter types you can experiment with new effects by selecting combinations of switches together. For example:

HPF+LPF = NOTCH. Used with RESONANCE you get a phasing effect.

HPF+BPF+LPF = ALL PASS. But with RESONANCE creates a dramatic effect.

Take some time to experiment with the filters before 'going live'...

External Input

An external input is provided in addition to the mono and stereo channels. Use this either as another input to the mix or as an external monitor source only.

INPUTS A pair of 1/4" TRS jacks accepts a line level stereo or mono source. For stereo sources plug into the L and R inputs. For mono sources plug into the L input only leaving the R input unplugged. In this case the mono signal is normalled through the R input socket. Operating level is -10dBV as standard but may be changed to +4dBu by resoldering an internal link.

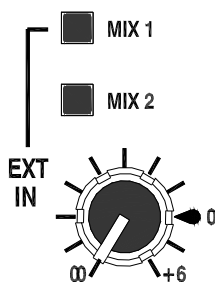

ROUTING SWITCHES Two switches route the signal to Mix1, Mix2, both or none. These are tamperproof to prevent accidental operation during performance. Decide how the external inputs are to be used. There are two main applications:

Mix Input To connect additional stereo or mono sources to either or both Mix1 and Mix2. For example, you could return the processed output from an effects device such as reverb back into the mix, you could accept an input from a submixer to feed the same speaker system, or you could replay a recording through the PA. Cue the source by pressing the monitor selector EXT switch. The signal is monitored pre-level. Use a pointed object such as a pen to select the routing switches as required.

Monitor Only Input To return sources to the monitor selector for monitoring only. With both switches in the up position the signal feeds the monitor source selector and is not affected by the level control. This is the case when the input is used for monitoring only and should not feed the main mix, for example checking your recording of the mix. The tamperproof underpanel routing switches prevent accidental operation. If the switch were accidentally pressed during recording the signal would route back on itself and feed back electronically.

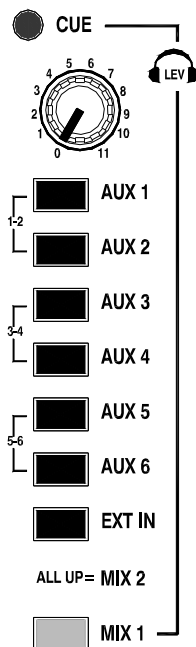

LEVEL The rotary control adjusts the level of the external input to Mix1 or Mix2 or both as selected on the routing switches above. Note that it does not affect the feed to the monitor selector. The control adjusts from fully off to a maximum +6dB boost. The normal 0 operating position is marked.

MONITOR SELECT Press EXT in the monitor select switch bank to listen to the input in the headphones and local booth monitor. The signal level is displayed on the monitor meters. The EXT selection is automatically overridden when any Aux monitor or Cue switch is pressed. Pressing EXT overrides the Mix1 and Mix2 selection. For example, you could be listening to the music mix with MIX1 pressed, then press EXT to check the recording. You do not need to release MIX1 first.

Master Mix

The **XONE:464** provides two independent stereo mix outputs, Mix1 and Mix2. The mono channels can be routed to either or both outputs. The stereo channels route to Mix1 only, either direct or through the crossfader. However, Mix1 can be routed to Mix2 as the music feed to the main music + mics mix if required.

Both outputs provide master fader control, inserts, metering, balanced XLR main outputs, and RCA phono secondary outputs, ideal for recording the performance. An additional mono output with both XLR and TRS jack outputs can be assigned from either mix using a rear panel switch. These are ideal for feeding a sub-bass, mono zone and sound-to-light system. This unique output capability is able to satisfy the most demanding audio system applications.

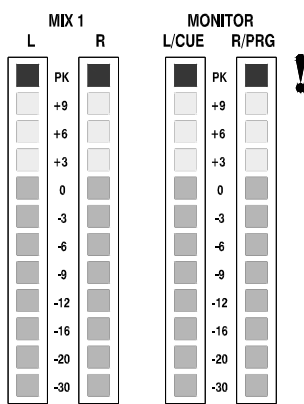

MIX1 METERS A pair of meter bars displays the post-master left and right output levels of stereo Mix1. Each meter has 12 leds to indicate signal levels from as low as -30dB . Green and yellow leds indicate normal operating levels. The top red led lights at $+16\text{dB}$ to warn that you are within 5dB of clipping. Meter '0' represents $+4\text{dBu}$ at the main outputs. The meters are peak responding. This means that they have a fast attack and are able to display fast transients accurately. With the output masters at maximum you should adjust the mix so that the signal averages '0' on the meters with highest peaks no more than '+6'. This still leaves plenty of mix headroom.

MONITOR / MIX2 METERS A pair of meter bars displays the level of the selected monitor source or CUE. With all selector switches up these default to display the post-master left and right output levels of stereo Mix2.

MIX1 to MIX2 Routes the pre-master Mix1 signal to Mix2 to create a stereo subgroup. For example, use Mix1 to feed the dance floor, Mix2 to feed the stage PA. Press the underpanel MIX1 to MIX2 switch to route the music only dance mix to the stage PA. Note that the Mix1 master control does not affect the Mix1 level to Mix2. This is a tamperproof underpanel switch to avoid accidental operation in situations where Mix1 and 2 are used as independent outputs. It should be selected using a pen or similar pointed object.

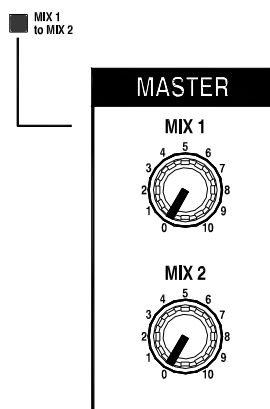

MASTER ROTARIES Mix1 and Mix2 each have a rotary master control to adjust the output level. Each is a stereo rotary which adjusts the left and right signals at the same time. The '10' mark indicates maximum level operating position. If you find yourself normally setting the master control in the lower half of its travel then the connected equipment may be too sensitive for the operating level of the console. With the master control set to its '10' position adjust the input level trim of the connected equipment for the loudest output required. Note that the insert points are pre-master. These can be used to patch in compressors and limiters to protect the system from excessive sound levels.

▲ In a club or similar installation strict sound level and noise regulations may apply. Check that your system levels are correctly set up to comply.

Console Monitor System

The **XONE:464** provides extensive console monitoring facilities. Every signal can be checked individually or within any mix. Two systems are provided, headphones and local monitor. The local monitor typically feeds the DJ booth speaker system. The Cue system lets you quickly check channel signals, correctly set the gain, and cue tracks ready to bring into the mix. Facilities such as Mono and Split-Cue switching are well suited to the way the professional DJ works.



HEADPHONES 1 OUTPUT Two outputs are available for stereo headphones, one on the front panel, the other on the rear panel. The same signal is available from both. Headphones are available in many different styles, impedances and volume ratings. To get the best from your system we recommend that you use high quality closed-ear headphones in the range 30 to 600 ohms. 8 Ohm headphones are not recommended.

WARNING Some headphones are more sensitive than others and can produce higher output levels. To avoid damage to your hearing start with the PHONES level control at minimum and turn up only as much as is needed to maintain comfortable listening level. Do not drive headphones at high listening levels for long periods of time.

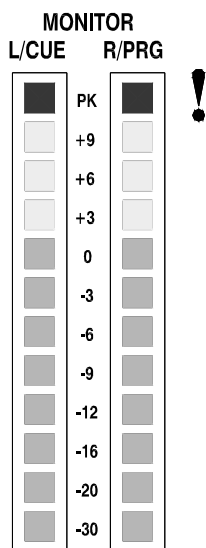

MONITOR / MIX2 METERS A pair of meter bars displays the level of the selected monitor source or CUE. With all selector switches up these default to display the post-fader left and right output levels of stereo Mix2. When SPLIT CUE is selected the left meter displays the active CUE signal, the right displays PRG (program), the switch bank source in mono.

Each meter has 12 leds to indicate signal levels from a low -30dB. Green and yellow leds indicate normal operating levels. The top red led lights at +16dB to warn that you are within 5dB of clipping. Meter '0' represents +4dBu at the XLR outputs. The meters are peak responding. This means that they have a fast attack and are able to display fast transients accurately.

CUE A large red led lights when a channel CUE is active. This indicates that the selected channel CUE signal is heard in the headphones and displayed on the monitor meters. CUE also overrides the local monitor if CUE ENABLE has been selected.

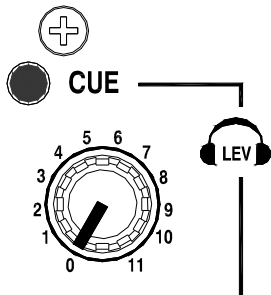

It is important to use CUE to set the channel gains correctly to maintain the wide dynamic range achievable with this console. You should adjust the channel gain so that the signal averages '0' on the monitor meters with highest peaks no more than '+6'. Reduce the gain if the red PK leds flash.

HEADPHONES LEVEL Adjusts the level of the signal in the stereo headphones. This does not affect the level of the local monitor. Read the warning printed above regarding loud listening levels.

MONITOR SOURCE SELECTOR An 8 way switch bank is used to select which signal is heard in the headphones, local monitor and displayed on the meters. This defaults to post-fader Mix2 signal with all switches up. Press the required switch to monitor Mix1, Aux 1 to 6, or Ext in. CUE automatically overrides the selected source. Press a related pair of Aux switches to monitor them in stereo, for example Aux 5 on left, Aux 6 on right. Press a single AUX switch to check it in mono.

Switch priority is CUE overrides Aux 1/2 overrides Aux 3/4 overrides Aux 5/6 overrides Ext overrides Mix1 overrides Mix2. For example you can select Mix1 as your source, then press Ext to check a recording level without having to first deselect Mix1.

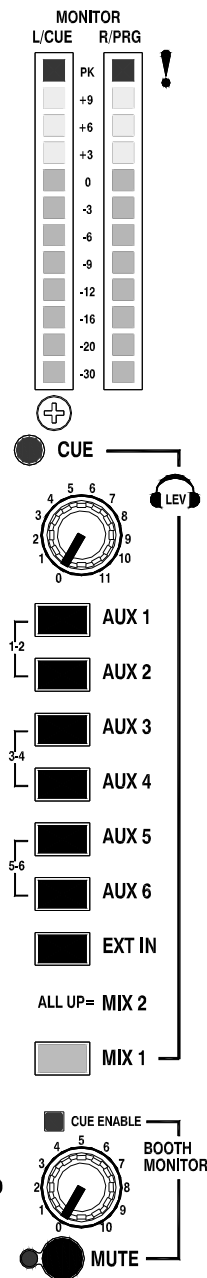

BOOTH MONITOR LEVEL Adjusts the level of the signal to the stereo local monitor output jacks. This does not affect the level in the headphones.

CUE ENABLE With this switch in its down position CUE automatically overrides the selected source in the local monitor. The switch is recessed to prevent accidental operation once it has been configured. In the up position CUE affects the headphones but not the booth monitor. In club mixing the local monitor feeds a booth speaker system. The DJ may prefer to cue using headphones only.

MUTE Press this switch to mute the local monitor output. The switch cap lights when the monitor is muted. The headphones are not affected. An internal option reconfigures the switch to attenuate the signal by 20dB rather than mute it if required, for example to keep some program audible at all times. Refer this work to competent service or installation personnel.

SPLIT CUE Press this switch to change the way CUE operates. Normally, pressing a channel CUE switch overrides both left and right monitor program signals with the cue signal. With the switch pressed, CUE overrides just the left channel. The left program signal sums with the right so that the program remains in the right monitor but in mono. The left monitor meter displays the cue signal, right displays program. This is invaluable in club mixing where the main program should remain audible while cueing other channels ready to bring them into the mix. It is very useful when beat mixing using headphones.

MONO Sums the left and right monitor signals together so that the selected stereo source can be checked in mono. Use this to check for mono compatibility and phase problems, especially important in dance floor and recording applications. A drop in level or loss of low frequencies when pressed indicates reversed phase between the left and right signals.

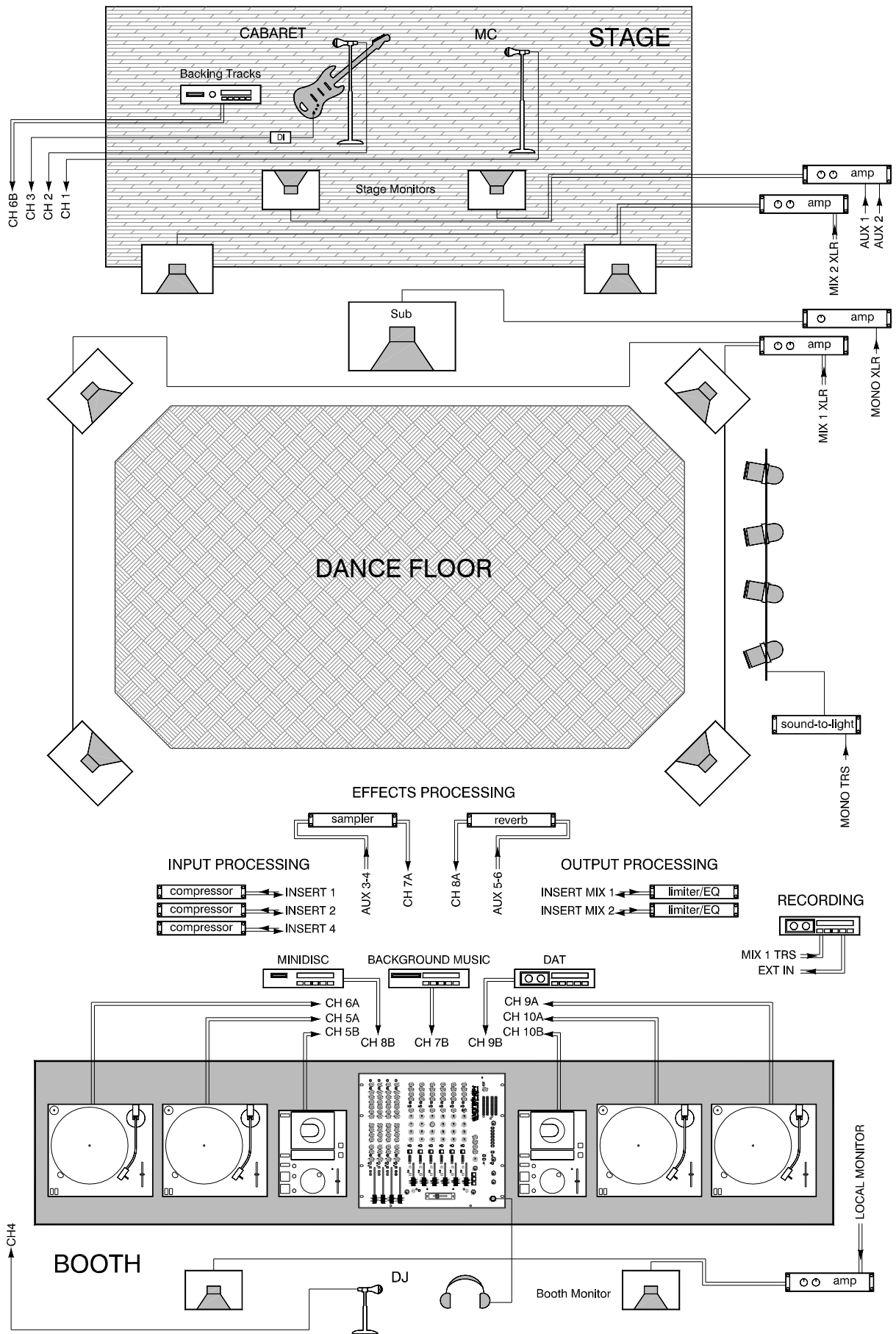

The Club Application

The **XONE:464** build quality, versatility and number of inputs and outputs make it ideal for high performance professional club installation.

Hybrid application The console provides facilities for dance/DJ and live/cabaret mixing. As a 'house' mixer it would be expected to alternate between house DJ, performance DJs, live acts, cabaret, karaoke, background music, and so on. The following example is just one of many possibilities, each dependent on the particular application. Refer to the diagram opposite.

Overview Here we have a club venue that features both house and guest DJ sessions providing a sound and light experience for the dance floor. **XONE:464** presents the DJ with a unique set of easy to use live performance tools to creatively manipulate the sound and excite the audience. The club maintains its appeal by staging live cabaret and music acts as well as the dance sessions. A typical evening may start with background music, move to dancing as the house DJ takes over, introduce the featured guest DJ performance, and then change the mood for some live cabaret, all this under the control of **XONE:464**. The sound system can be divided into three key areas:

BOOTH This is where the sound is controlled, typically overlooking the dance floor and raised so that the performance of the DJ can be seen. Flanked by the music sources the **XONE:464** forms the heart of the system. This example shows no fewer than 4 RIAA turntables, 2 CD decks, a background music CD player, and MiniDisc and DAT players for alternative format material. Note that while this illustrates the capability of **XONE:464** many real club applications may not need as many sources as this. The performance is enhanced by patching in a sampler effects unit. The DJ uses headphones to cue the sources, split-cue helping him match the beat between tracks. The local monitor output feeds high power booth monitor speakers so that the DJ can 'feel' the music. In this case the music only mix feeds these speakers with cue disabled to prevent cue spill on to the dance floor and to avoid feedback should he cue his own microphone. A stereo recorder is fed from Mix1 to record the music only performance.

DANCE FLOOR This is the dance area with high tech music system and light show. Typically, 4 speakers are hung, one at each corner, supplemented by a sub bass cabinet on the floor to enhance the low bass. **XONE:464** feeds these speakers with the music only mix derived from Mix1 output. The mono output is switched from Mix1 to feed the sub bass system. A socket is also provided to send the mono mix to the sound-to-light controller for music linked lighting effects. Sound level control is maintained by inserting output limiters to prevent system or hearing damage, or indeed a visit from the regulations authorities!

STAGE This is where the cabaret and live music acts are performed, typically alongside the dance floor. This example shows a solo singer/guitarist using MiniDisc backing tracks, and the club MC (Master of Ceremonies) who introduces the performances. Most of these small club acts do not require, or cannot afford, their own engineer driven mixing consoles. **XONE:464** provides all the facility needed to mix up to 4 microphones and additional stereo sources. As with professional live consoles, compressors are inserted into the mic channels to keep unexpected peaks in check. Similarly a reverb processor is patched in to add ambience to the live act. Dedicated left and right speakers face the dance floor and are fed with the Mix2 output. This is the microphone mix with music added by selecting the Mix1 to Mix2 underpanel routing switch. Note that the mic signals are prevented from getting to the dance floor speakers and lighting controller. Two stage monitor speakers are shown giving the musician and the MC their own independent mix fed from Aux 1 and 2.

Options

The **XONE:464** is designed to offer the utmost flexibility to satisfy your application without modification. However, the following internal link options are provided to allow customisation to satisfy the more specialist applications. Further information and details are printed in the **XONE:464 Service Manual** or available from Allen & Heath.



This work requires access to the internal assemblies and resoldering of circuit card links and should be carried out by competent technical personnel only.

Mono channel AUX options The pre-fade sends are set post-EQ, post-ON as standard. Links on the mono circuit cards can be resoldered to reconfigure pre-EQ and/or pre-ON.

Stereo channel AUX options The pre-fade sends are set post-EQ as standard. Links on the stereo circuit cards can be resoldered to reconfigure pre-EQ. Similarly the post-EQ cue feeds can be reconfigured pre-EQ.

Mono channel DIRECT outputs These are derived post channel fader as standard. A link on each card can be resoldered to reconfigure pre-fader. The direct out pre-fade source is the same as that configured to feed the aux sends.

EXT input level option The external inputs are set for -10dBV line level as standard. These can be reconfigured for $+4\text{dBu}$ operation by cutting track links on the connector card.

MUTE switch function This mutes the local monitor as standard. It can be reconfigured to attenuate the signal by 20dB by cutting a pair of track links on the right master circuit card.

Remote control of the MUTE function The right master circuit card provides solder pads to wire to the 25 pin REMOTE connector so local monitor MUTE can be activated by an external switch.

REMOTE user connector The blanking plate may be replaced with a standard 25 pin chassis mount female D-connector for custom wiring.

SYS-LINK output The blanking plate can be replaced with a 25 pin D-connector with circuit card. This provides access to all the console outputs and is compatible with any Allen & Heath console already fitted with the SYS-LINK expander system. A kit of parts is available from Allen & Heath.

Addendum: Model Changes – October 2000

There are minor changes between the original **XONE:464** and the revised model which replaces it and is referred to in this user guide. The order code XONE2:464/ refers to the revised model.

Styling The original stainless steel finish is replaced with a new textured silver paint. Several knob and pushbutton types have been changed to further co-ordinate the styling. There are minor changes to the graphics.

Master Level Controls The original MIX1 and MIX2 master linear faders have been replaced with rotary master controls.

Crossfader The new high grade Penny & Giles fader is fitted instead of the original Alps version. These are not interchangeable.

Headphones Socket The front panel socket has been moved from the top to lower right.

Tips and Troubleshooting

 For your safety do not remove the **EARTH** (ground) connection in the power lead of the console or connected equipment.

 Have your **MAINS SYSTEM** checked by a qualified electrician. If the earthing is solid to start with you are less likely to experience problems.

 Use high grade **AUDIO CABLES** and check them for reliable connection. It is well known that many audio system problems are due to faulty cables and connectors.

 In a club or similar installation strict **SOUND LEVEL** and noise regulations may apply. Check that your system levels are correctly set up to comply.

 To avoid damage to your hearing start with the **HEADPHONES** level control at minimum and turn up only as much as is needed to maintain comfortable listening level. Do not drive headphones at high listening levels for long periods of time.

 Always switch connected **AMPLIFIERS** on last and off first to avoid thumps when the console and connected equipment is turned on or off.

 Reduce gain if the red meter **PEAK** led flashes. These warn you that you are near clipping which may result in system overload and distortion. The **XONE:464** provides plenty of drive and headroom when operated around the 0 to +6 meter points.

 Increasing **VCF RESONANCE** boosts a narrow band of selected frequencies. Make sure you reduce the channel gain if the red peak meters start to flash. It is best to start experimenting with this control set to minimum.

 Use split-CUE to match the beat between two tracks when beat mixing. Alternatively, you can monitor Aux 3-4 and raise the sends on the two channels to give you a pre-fade **PREVIEW** of the mix which does not affect the main output. Select Aux 3 and 4 monitor switches together to listen in stereo. Pressing any CUE switch will override the preview.

 To control vocal microphone dynamics patch a **COMPRESSOR** into the mono channel insert. Start with its threshold set to 0dB and ratio around 2 or 3:1.

 **There are loud clicks when I plug microphones in.** Check that the rear panel +48V switches are selected only for microphones that require phantom powering. Do not connect unbalanced sources or cables to the XLR inputs when phantom power is selected. To avoid loud clicks always turn the channel off by releasing the ON switch when switching +48V on or off and when plugging or unplugging microphones with power applied.

 **The stereo channel sounds very distorted with excessive bass.** Check that you plug only turntables needing RIAA equalisation into CH 5,6,9 and 10 Phono A inputs. Other equipment should be plugged into these channel B inputs.

 **There is a hum on the turntable channels.** Check that the turntable earth strap has been correctly connected to the console chassis earth post.

 **Only one side of the stereo mix is working.** Check that the XFADE PAN control is not set fully to either L or R.

 **When the VCF is switched on there is very little sound.** Operate the VCF frequency control to restore the frequency content of the sound.

 **There is no microphone output when I raise the channel fader.** Check that the mic channel ON switch is pressed and that the Mix1,2 routing switches are correctly set. Also check that any compressors or other processors plugged into the inserts are turned on and correctly adjusted.

 **There is no monitor output.** Check that a channel CUE switch is not already selected. This is indicated by the red CUE led under the monitor meters.

 **There is no stereo channel signal.** Check that the input selector switch is in the correct position.

 **CUE is not working on the booth speakers.** Set the underpanel CUE DISABLE switch as required.

 **The EXT input is not working.** Check that the underpanel routing switches are correctly set.

 **The crossfader works backwards.** Check that it has been re-fitted the right way round if previously removed.

XONE:464 CUE SHEET

Photocopy and use to log your console settings

1	2	3	4

5	6	7	8	9	10
A RIAA	A RIAA	A	A	A RIAA	A RIAA
B	B	B	B	B	B

EXT

--

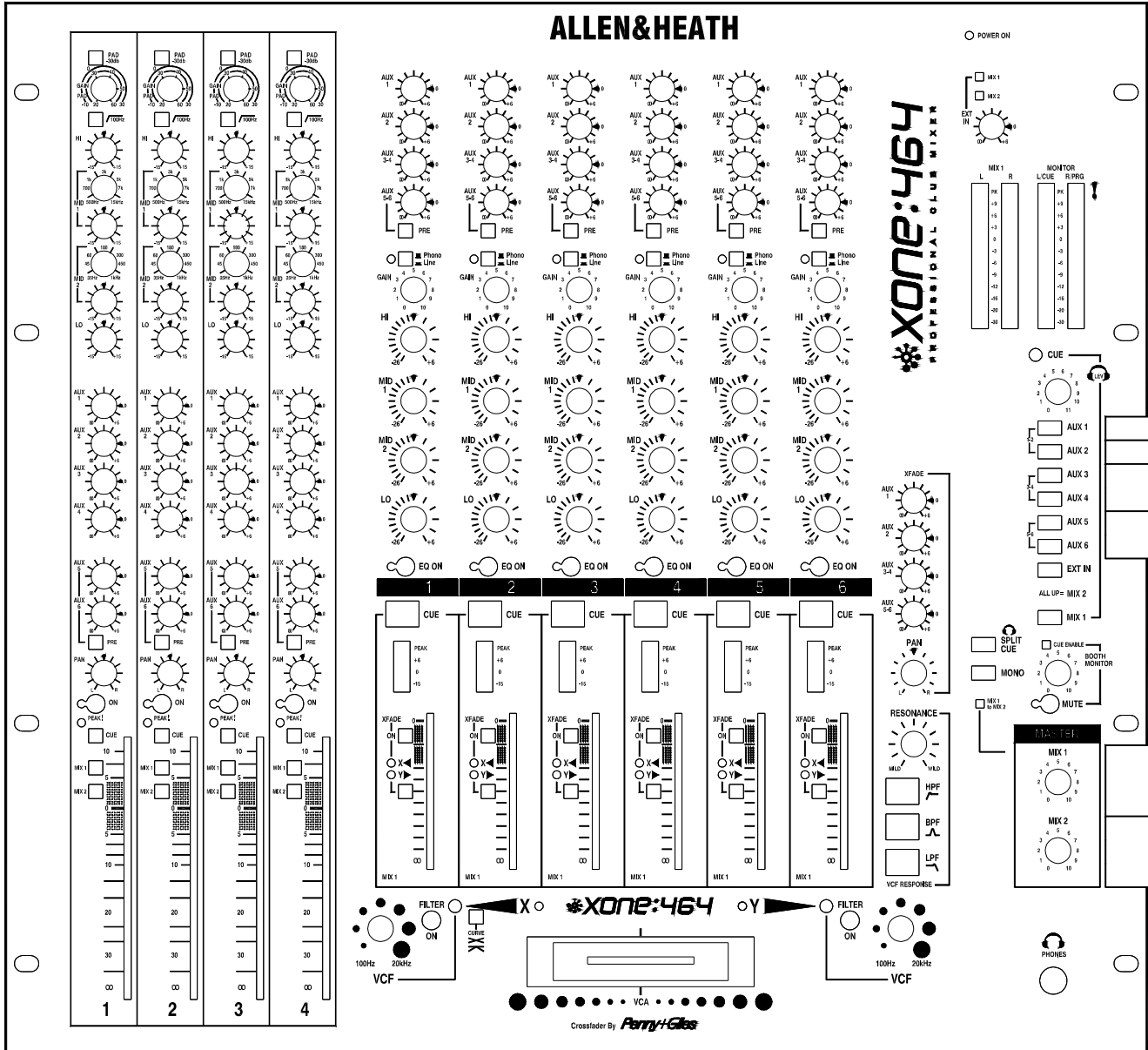

--	--