



CSP-428 & CSP-1248

Commercial Sound Processors

Installation Guide



Please read and keep all safety and use instructions.

This product is intended for installation by professional installers only! This document is intended to provide professional installers with basic installation and safety guidelines for this product in typical fixed-installation systems. Please read this document and all safety warnings before attempting installation.

Do not attempt to service this product yourself. Refer all servicing to authorized service centers, installers, technicians, dealers or distributors. To contact Bose Professional or to find a dealer or distributor near you, visit PRO.BOSE.COM.

- Read these instructions.
- Keep these instructions.
- Heed all warnings.
- Follow all instructions.
- Do not use this apparatus near water.
- Clean only with a dry cloth.
- Do not block any ventilation openings. Install in accordance with the manufacturer's instructions.
- Do not install near any heat sources such as radiators, heat registers, stoves, or other apparatus (including amplifiers) that produce heat.
- Do not defeat the safety purpose of the polarized or grounding-type plug. A polarized plug has two blades with one wider than the other. A grounding type plug has two blades and a third grounding prong. The wide blade or the third prong are provided for your safety. If the provided plug does not fit into your outlet, consult an electrician for replacement of the obsolete outlet.
- Protect the power cord from being walked on or pinched particularly at plugs, convenience receptacles, and the point where they exit from the apparatus.
- Only use attachments/accessories specified by the manufacturer.
-  Use only with the cart, stand, tripod, bracket, or table specified by the manufacturer, or sold with the apparatus. When a cart is used, use caution when moving the cart/apparatus combination to avoid injury from tip-over.
- Unplug this apparatus during lightning storms or when unused for long periods of time.
- Refer all servicing to qualified personnel. Servicing is required when the apparatus has been damaged in any way, such as power-supply cord or plug is damaged, liquid has been spilled or objects have fallen into the apparatus, the apparatus has been exposed to rain or moisture, does not operate normally, or has been dropped.

WARNINGS/CAUTIONS:

-  This symbol on the product means there are important operating and maintenance instructions in this guide.
-  This symbol on the product means there is uninsulated, dangerous voltage within the product enclosure that may present a risk of electrical shock.
-  Contains small parts which may be a choking hazard. Not suitable for children under age 3.

All Bose products must be installed in accordance with local, state, federal and industry regulations. It is the installer's responsibility to ensure installation of the loudspeakers and mounting system is performed in accordance with all applicable codes, including local building codes and regulations. Consult the local authority having jurisdiction before installing this product.

Unsafe mounting or overhead suspension of any heavy load can result in serious injury or death, and property damage. It is the installer's responsibility to evaluate the reliability of any mounting method used for their application. Only professional installers with the knowledge of proper hardware and safe mounting techniques should attempt to install any loudspeaker overhead.

Do not mount the product in locations where condensation may occur.

This product is not intended for installation or use in indoor water facility areas (including, without limitation, indoor pools, indoor water parks, hot tub rooms, saunas, steam rooms and indoor skating rinks).

To reduce the risk of fire or electrical shock, do NOT expose this product to rain, liquids or moisture.

Keep the product away from fire and heat sources. Do NOT place naked flame sources, such as lighted candles, on or near the product.

Do NOT make unauthorized alterations to this product.

Do NOT use a power inverter with this product.

Do NOT use in vehicles or boats.

Provide an earth connection or ensure the socket outlet incorporates a protective earthing connection before connecting the plug to the mains socket outlet.

Dansk: Apparatets stikprop skal tilsluttes en stikkontakt med jord, som giver forbindelse til stikproppens jord.

Suomi: Laite on liitettävä suojamaadoituskoskettimilla varustettuun pistorasiaan.

Norsk: Apparatet må tilkoples jordet stikkontakt.

Svenska: Apparaten skall anslutas till jordat uttag.

Where the mains plug or an appliance coupler is used as the disconnect device, the disconnect device shall remain readily operable.

Do not expose products containing batteries to excessive heat (e.g. from storage in direct sunlight, fire or the like).

Only use the mounting hardware recommended by the rack manufacturer.

Due to ventilation requirements, Bose does not recommend placing the product in a confined space such as in a wall cavity or in an enclosed cabinet.

Do not place or install the bracket or product near any heat sources, such as fireplaces, radiators, heat registers or other apparatus (including amplifiers) that produce heat.

Regulatory Information

CAN ICES-3 (A)/NMB-3(A)

This device complies with part 15 of the FCC Rules. Operation is subject to the following two conditions: (1) This device may not cause harmful interference, and (2) this device must accept any interference received, including interference that may cause undesired operation.

NOTE: This equipment has been tested and found to comply with the limits for a Class A digital device, pursuant to part 15 of the FCC Rules. These limits are designed to provide reasonable protection against harmful interference when the equipment is operated in a commercial environment. This equipment generates, uses, and can radiate radio frequency energy and, if not installed and used in accordance with the instruction manual, may cause harmful interference to radio communications. Operation of this equipment in a residential area is likely to cause harmful interference in which case the user will be required to correct the interference at their own expense.

Changes or modifications not expressly approved by Bose Corporation could void the user's authority to operate this equipment.

WARNING: This is a class A product. In a domestic environment this product may cause radio interference in which case the user may be required to take adequate measures.

Shielded cables are required to maintain regulatory compliance.

This product meets all EN55103-2 immunity requirements for E2 electromagnetic environment.

 This product conforms to all applicable EU directive requirements. The complete declaration of conformity can be found at: www.Bose.com/compliance.

 This symbol means the product must not be discarded as household waste, and should be delivered to an appropriate collection facility for recycling. Proper disposal and recycling helps protect natural resources, human health and the environment. For more information on disposal and recycling of this product, contact your local municipality, disposal service, or the shop where you bought this product.

China Restriction of Hazardous Substances Table

Names and Contents of Toxic or Hazardous Substances or Elements						
Part Name	Toxic or Hazardous Substances and Elements					
	Lead (Pb)	Mercury (Hg)	Cadmium (Cd)	Hexavalent (CR(VI))	Polybrominated Biphenyl (PBB)	Polybrominated diphenyl ether (PBDE)
PCBs	X	0	0	0	0	0
Metal Parts	X	0	0	0	0	0
Plastic Parts	0	0	0	0	0	0
Speakers	X	0	0	0	0	0
Cables	X	0	0	0	0	0

This table is prepared in accordance with the provisions of SJ/T 11364.
 0: Indicates that this toxic or hazardous substance contained in all of the homogeneous materials for this part is below the limit requirement of GB/T 26572.
 X: Indicates that this toxic or hazardous substance contained in at least one of the homogeneous materials used for this part is above the limit requirement of GB/T 26572.



Taiwan Restriction of Hazardous Substances Table

Equipment name: CSP-428, CSP-1248, Type designation: 808934, 808935						
Restricted substances and its chemical symbols						
Unit	Lead (Pb)	Mercury (Hg)	Cadmium (Cd)	Hexavalent chromium (Cr+6)	Polybrominated biphenyls (PBB)	Polybrominated diphenyl ethers (PBDE)
PCBs	-	o	o	o	o	o
Metal Parts	-	o	o	o	o	o
Plastic Parts	o	o	o	o	o	o
Speakers	-	o	o	o	o	o
Cables	-	o	o	o	o	o

Note 1: "o" indicates that the percentage content of the restricted substance does not exceed the percentage of reference value of presence.
Note 2: The "-" indicates that the restricted substance corresponds to the exemption.

Date of Manufacture: The eighth digit in the serial number indicates the year of manufacture; "7" is 2007 or 2017.

China Importer: Bose Electronics (Shanghai) Company Limited, Part C, Plan 9, No. 353 North Ruyi Road, China (Shanghai) Pilot Free Trade Zone

EU Importer: Bose Products B.V., Gorslaan 60, 1441 RG Purmerend, The Netherlands

Mexico Importer: Bose de México, S. de R.L. de C.V., Paseo de las Palmas 405-204, Lomas de Chapultepec, 11000 México, D.F. For importer & service information: +5255 (5202) 3545

Taiwan Importer: Bose Taiwan Branch, 9F-A1, No. 10, Section 3, Minsheng East Road, Taipei City 104, Taiwan. Phone Number: +886-2-2514 7676

Google and Chrome are trademarks of Google LLC.

Mozilla and Firefox are registered trademarks of the Mozilla Foundation.

Arm is a registered trademark of Arm Limited (or its subsidiaries) in the US and/or elsewhere.

All other trademarks are the property of their respective owners.

Bose Corporation Headquarters: 1-877-230-5639

©2018 Bose Corporation. Bose is a trademark of Bose Corporation. No part of this work may be reproduced, modified, distributed or otherwise used without prior written permission.

Warranty Information

This product is covered by a limited warranty. For warranty details, visit PRO.BOSE.COM.

Overview	9
Product Features	9
Package Contents	10
Available Accessories	11
Product Details	12
CSP-428/CSP-1248	12
Front Panel	12
Rear Panel	13
Installation	14
Rack-mounting	14
Analog Audio Connections	14
AVM-1	14
AmpLink Connection	15
CC-1D/CC-2D/CC-3D	15
Mute with Standard Contact Closure	15
Control I/O Connections	16
Control Inputs	16
Control Output	16
Network Connection	17
Power Connection	17
Accessing the CSP Configuration Utility	17
Maintenance	18
Firmware & Software Updates	18
Battery Replacement	18
Troubleshooting	19
Technical Information	20
Technical Specifications	20
CSP-428	20
CSP-1248	22

Overview

Bose Professional CSP-1248 and CSP-428 commercial sound processors offer right-sized I/O and simplified configuration for small-to-medium scale projects. They are designed to serve as standalone DSP in commercial applications such as retail stores and restaurants, or any public place where modest processing, high-quality sound and facilitated installation is desired. Models feature a quick-setup workflow, using an integrated web server with browser-based configuration utility, for making common tasks intuitive and logical – ultimately reducing installation time. Integrated Bose-proprietary algorithms offer predictable control options, while compatible interfaces like ControlCenter digital controllers and ControlSpace Remote offer reliable, convenient operation for end users.

Product Features

Right-sized connectivity for cost-effective commercial installation options. Models feature balanced analog I/O (CSP-1248: 8 × 4, CSP-428: 2 × 2), mono-summed RCA inputs (CSP-1248: 4 pair, CSP-428: 2 pair), 8 control inputs, 1 control output, a mute contact, Ethernet network (for configuration or wall control) and Bose AmpLink.

CSP configuration utility provides an intuitive setup interface via the CSP's integrated web-server so that you can quickly configure the CSP using a web browser.

Rear-panel Ethernet connection provides a local port for configuration via computer and a wider network connection for control from compatible ControlCenter digital wall controllers or ControlSpace Remote clients

AutoVolume compensation continuously adapts zone output level based on the ambient noise of an active space, as to maintain consistent program material (requires the Bose AVM-1 sense microphone accessory)

Opti-voice paging provides a smooth transition between the music and page signals



Opti-source level management monitors the input level of up to four sources. Source levels are continually adjusted to maintain a consistent volume level among different source.

SmartBass equalization enhances the low-frequency output of select loudspeakers

Bose AmpLink output for simplified digital audio connectivity to supported power amplifiers

Package Contents

Your Bose CSP includes the following accessories, depending on the model: **CSP-428** or **CSP-1248**:

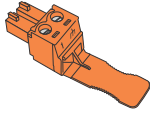
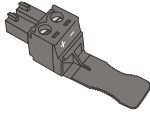
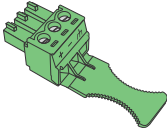
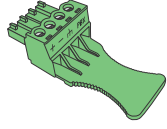
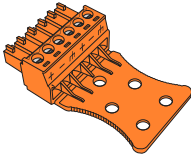
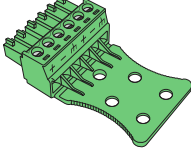
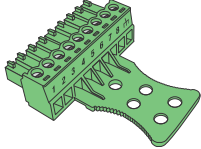
Accessories	CSP-428	CSP-1248	
	AC power cord	1	1
	Cable ties	11	11
	2-pin Euroblock (orange)	1	1
	2-pin Euroblock (black)	1	1
	3-pin Euroblock (green)	1	1
	4-pin Euroblock (green)	1	1
	6-pin Euroblock (orange)	1	2
	6-pin Euroblock (green)	0	3
	9-pin Euroblock (green)	1	1

Available Accessories

The CSP-428 and CSP-1248 are compatible with Bose ControlCenter digital zone controllers and the AVM-1 sense microphone. Below is a list of compatible devices:

Model	Part Number	Notes
ControlSpace ControlCenter CC-1D	PC 079059 (US, white)	Uses Network port. Requires additional Power-over-Ethernet (PoE) switch.
	PC 079051 (US, black)	
	PC 079042 (EU, white)	
	PC 079070 (EU, black)	
	PC 079062 (JP, white)	
	PC 079060 (JP, black)	
ControlSpace ControlCenter CC-2D	PC 079063 (US, white)	Uses Network port. Requires additional Power-over-Ethernet (PoE) switch.
	PC 079043 (US, black)	
	PC 079071 (EU, white)	
	PC 079049 (EU, black)	
	PC 079066 (JP, white)	
	PC 079046 (JP, black)	
ControlSpace ControlCenter CC-3D	PC 079061 (US, white)	Uses Network port. Requires additional Power-over-Ethernet (PoE) switch.
	PC 079047 (US, black)	
	PC 079053 (EU, white)	
	PC 079058 (EU, black)	
	PC 079041 (JP, white)	
	PC 079064 (JP, black)	
AVM-1 sense microphone	PC 079067 (white)	Uses analog input with Euroblock connector.

Product Details

CSP-428/CSP-1248

Front Panel

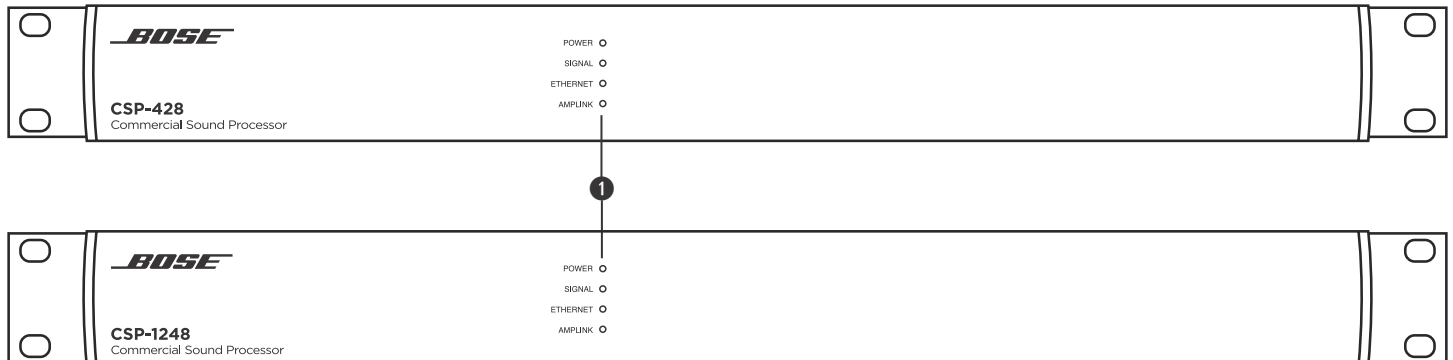

1 LED Indicators

Power:	Power or fault state indication.	Green: Power on, normal operation Yellow: Powering on Red: Error (see Troubleshooting on page 19)
Signal:	Signal status indication of all audio input and output channels in order of signaling priority.	Green: Signal present (-60 dBFS to -20 dBFS) Yellow: Signal level optimal (-20 dBFS to -2 dBFS) Red: Clipping (-2 dBFS to 0 dBFS)
Ethernet:	Connection status indication of Ethernet ports.	Green: Ethernet link established Yellow: Active transmission/reception
AmpLink:	Connection status indication of AmpLink-equipped amplifiers.	Green: AmpLink is active

Rear Panel

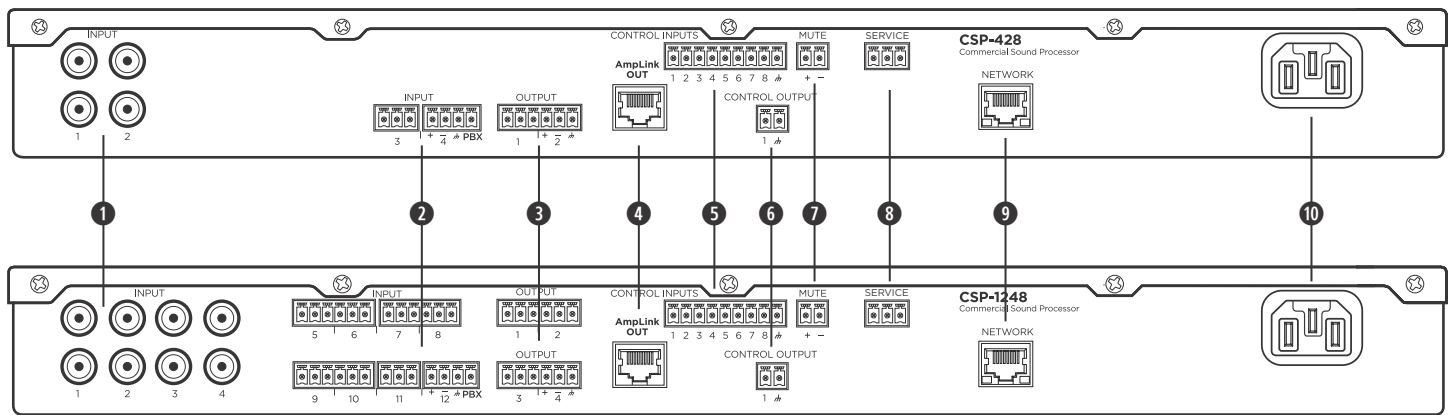

- ❶ **RCA Inputs:** Summed mono inputs for analog audio connections. See **Installation > Analog Audio Connections** (page 14) for more information.
- ❷ **Analog Inputs:** Mic/line-level inputs for balanced analog audio signals. To integrate the CSP into a telephone switching system, use the **PBX** (private branch exchange) terminal. To use the built-in AutoVolume feature, connect one or more Bose AVM-1 sense microphones to any of these inputs (see the AVM-1 installation guide for more information). See **Installation > Analog Audio Connections** (page 14) for more information.
Note: The AutoVolume feature is optimized for use with Bose AVM-1 sense microphones only.
- ❸ **Analog Outputs:** Line-level outputs for balanced analog audio signals. See **Installation > Analog Audio Connections** (page 14) for more information.
- ❹ **AmpLink Out port:** RJ-45 connection for use with AmpLink-equipped amplifiers. Use shielded EIA/TIA 568B straight Cat 5 cables (or equivalent) to make this connection. See **Installation > AmpLink Connection** (page 15) for more information.
CAUTION: Shielded EIA/TIA 568B straight Cat 5 cables (or equivalent) are required for proper AmpLink operation. Unshielded cables are **not** supported and may cause AmpLink audio to operate improperly. Do **not** connect an AmpLink port to an Ethernet-based network.
- ❺ **Control Inputs:** Eight inputs for control of push-to-talk (PTT) paging. See **Installation > Control I/O Connections > Control Inputs** (page 16) for more information.
- ❻ **Control Output:** One output for general purpose control with ControlSpace Remote. See **Installation > Control I/O Connections > Control Output** (page 16) for more information.
- ❼ **Mute port:** Contact closure connection where a short across the mute connector will mute all outputs. See **Installation > Mute with Standard Contact Closure** (page 15) for more information.
- ❽ **Service port:** For Bose service use only.
- ❾ **Network port:** Ethernet network connection for up to 16 ControlCenter digital zone controllers via a PoE switch. See **Installation > Network Connection** (page 17) for more information.
- ❿ **Power input:** Power cord connection (IEC 60320-C14 inlet). See **Installation > Power Connection** (page 17) for more information.

Installation

Rack-mounting

The CSP-428 and CSP-1248 fit standard 48-centimeter (19-inch) rack equipment, occupying one rack unit (1 RU) in height and requiring a mounting depth of 208 millimeters (8.2 inches) from the front rack rail. Use four fasteners with washers (not included) to mount the CSP.

The CSP-428 and CSP-1248 use active side ventilation and can safely operate in ambient conditions from 0 °C to 40 °C (32 °F to 104 °F).

See **Technical Specifications** (page 20) for power dissipation ratings for each model.

Analog Audio Connections

The CSP-428 and CSP-1248 include two types of **analog inputs** for audio devices: summed mono RCA connectors and balanced Euroblock connectors. The **analog outputs** are balanced Euroblock connectors.

The termination end of each Euroblock connector includes printed terminal block descriptions. The following diagrams show the recommended balanced/unbalanced wiring between the audio connectors on the processor and common audio connectors to external audio components.

To integrate the processor into a telephone switching system, use the **PBX** (private branch exchange) terminal.

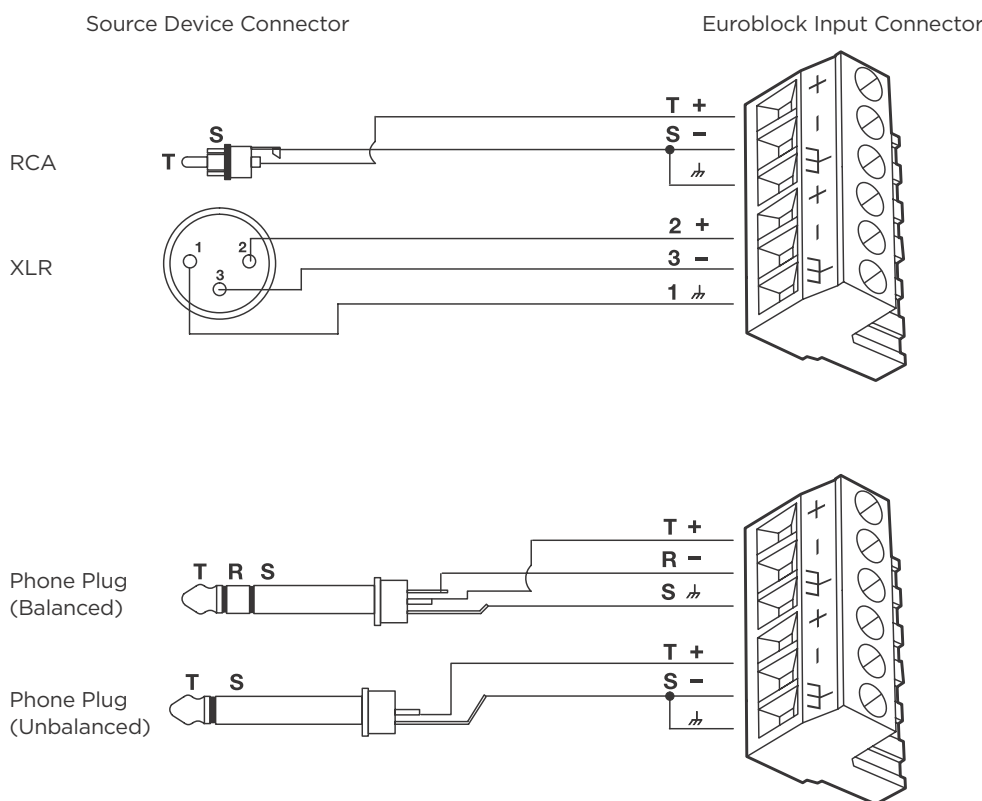

AVM-1

To use the built-in AutoVolume feature, use one or more Bose AVM-1 sense microphones with the CSP. Insert the -, +, and **ground** wires connected to the AVM-1 to the corresponding terminals of a Euroblock included with the Bose CSP. Connect that Euroblock to an **analog input** on the rear panel of the Bose CSP.

See the AVM-1 installation guide for more information.

Note: The AutoVolume feature is optimized for use with Bose AVM-1 sense microphones only.

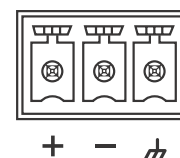

AmpLink Connection

The **AmpLink Out** port provides a low-latency method for transporting up to eight channels of uncompressed digital audio to AmpLink-compatible amplifiers. For simplified audio distribution, the CSP-428 and CSP-1248 can also serve as centralized input-routing/mixing points to one or more AmpLink-compatible amplifiers when installed in the same rack. Each amplifier must have a built-in AmpLink port or an AmpLink 24-channel input card installed.

AmpLink OUT

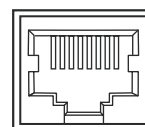

Use shielded EIA/TIA 568B straight Cat 5 cables (or equivalent) to make this connection. You can daisy-chain up to eight AmpLink-compatible products with up to 10 meters (32 feet) of cable between each product.

CAUTION: Shielded EIA/TIA 568B straight Cat 5 cables (or equivalent) are required for proper AmpLink operation. Unshielded cables are **not** supported and may cause AmpLink audio to operate improperly. Do **not** connect an AmpLink port to an Ethernet-based network.

CC-1D/CC-2D/CC-3D

The ControlCenter CC-1D, CC-2D, and CC-3D can be used for volume and mute control. The CC-2D and CC-3D can also be used for source control. You can connect these controllers to the **Network** port via a PoE network switch (not included). You can connect up to 16 controllers or up to 32 controllers, depending on the amplifier you are using with the CSP.

NETWORK

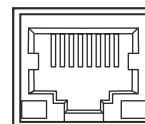

Use a foiled or unshielded twisted-pair (F/UTP) Cat 5e cable (not included) to connect this port on each CSP to your network or computer. Make this connection directly to the CSP or through a switched Ethernet network.

See **Overview > Available Accessories** (page 11) for a list of compatible accessories.

Mute with Standard Contact Closure

The CSP-428 and CSP-1248 are designed to mute all outputs either when the **Mute** contacts are either shorted together or opened, depending on how the CSP is configured.

The default state is Normally Open (NO), where a short across the mute connector will mute all outputs. Using the CSP integrated web server, the mute polarity can be inverted to Normally Closed (NC), where an open across the mute connector will mute all outputs.

Note: All LED indicators will blink red when the amplifier is muted from software or from the rear panel **Mute** connector.

Use the included black 2-pin Euroblock to make this connection.

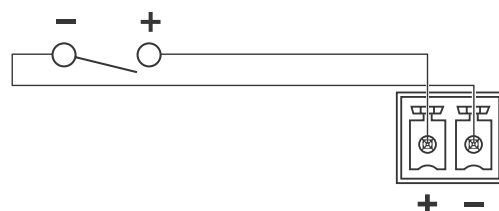

Control I/O Connections

The CSP can interface with external control hardware via the eight control inputs and one control output.

Control Inputs

You can connect the **control inputs** to external hardware such as switches to control push-to-talk (PTT) paging. Use the CSP configuration utility to easily assign how the paging functions work.

Using Switches

You can use toggle switches or push-buttons with control inputs. Each input terminal is tied to an internal two-kiloohm pull-up resistor so that external switches can be wired directly from input to ground.

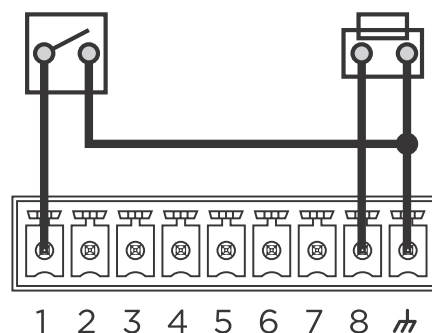

Example: Control input connections for switches

Control Output

Note: The control output is intended for use with ControlSpace Remote only.

Current Source Devices

The **control output** can power some devices such as LEDs and low-current relays directly. The maximum source current is 10 milliamps.

Source Limits: Open circuit, ≤ 8 VDC; 2.5 VDC and 10 mA (maximum) for external devices.

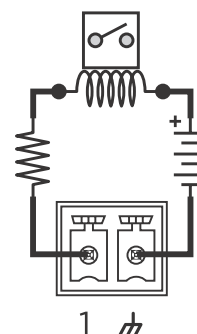

Example: Control output connections for a current source

Current Sink Devices

Devices that require more current than is available from a current-source configuration can use the **control output** to sink up to 100 milliamps when used with external power supplies. Use proper precautions when driving inductive loads.

Sink Limits: 100 mA (maximum). External supplies must be ≤ 24 VDC.



Example: Control output connections for a current sink

Network Connection

The CSP-428 and CSP-1248 include a **Network** port on the rear panel for network connection.

Use a foiled or unshielded twisted-pair (F/UTP) Cat 5e cable (not included) to connect this port on each CSP to your network or computer. Make this connection directly to the CSP or through a switched Ethernet network.

NETWORK

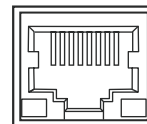

Power Connection

The CSP-428 and CSP-1248 can operate with AC mains line voltages from 85 volts to 264 volts at 50 Hz/60 Hz over a detachable IEC power cord. Power consumption is 37 volt-amperes at an ambient temperature of 40 °C (104 °F).

To power on the CSP, use the included power cord to connect the processor's power inlet to a power outlet. After powering on, the boot time may be as long as 40 seconds. The processor is fully operable when the **Power** LED on the front panel is lit solid green.

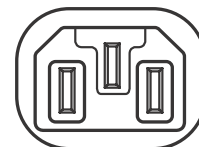
POWER 

Accessing the CSP Configuration Utility

To set the functions of the CSP, follow the steps below to access the CSP configuration utility hosted on its integrated web server.

Note: The integrated web server is compatible only with Google Chrome, Mozilla Firefox, Microsoft Edge, and Internet Explorer.

1. Visit [bosepro.link/cpsw](https://www.bosepro.link/cpsw) and download the **Discovery Tool** application.
2. Connect your computer to the **Network** port of your CSP (see **Network Connection** above).
3. Install and open the **Discovery Tool** application.
4. In the application, click **Discover**. The IP address of each CSP in the network will appear in the window.
5. Enter the network address of the desired CSP into the address bar of your web browser, and press **Enter**. The CSP configuration utility will appear in the browser window.

To learn more, access the help system from within the interface of the CSP configuration utility.

Maintenance

Firmware & Software Updates

Bose periodically releases updates for the CSP firmware. Follow the steps below to update the firmware of your CSP.

1. Open the CSP configuration utility (see **Accessing the CSP Configuration Utility** on page 17).
2. Access **Settings > Firmware > Select File**.
3. Select the firmware file on your computer, and then click **Open**.
4. In the browser window, click **Update**.

 **CAUTION:** Do not disconnect the CSP from your computer until you see a message that the update is complete. Interrupting the connection can damage the firmware on the CSP.

Battery Replacement

The CSP-428 and CSP-1248 each contain a replaceable lithium battery for maintaining the real-time clock (RTC) capability of the system. This battery lasts at least 10 years from the time of production and rarely requires replacement.

Troubleshooting

Problem	What to do
The Power LED on the front panel is not lit solid green.	Use the included power cord to connect the processor's power inlet (on the rear panel) to a power outlet. Make sure that the mains power is active.
The power is on, but there is no sound.	Verify that there is an input signal from the source using the CSP configuration utility. The audio input metering should be in the green/yellow band. Verify that there is an output signal. The audio output signal metering should be in the green/yellow band.
The sound is distorted.	Check the audio input signal indicators using the CSP configuration utility. If any of the audio input metering is in the red band, reduce the gain of the audio input or the output volume of the audio device. If the input and output indicators are green, and if you are sure the output volume of the audio device is undistorted when it enters the processor, make sure that the loudspeakers are not being overdriven or are not damaged.
The Power LED is red.	Disconnect the power cord from the power outlet, and then reconnect it. If the issue continues, call your Bose Professional sales/support representative.
The Ethernet LED is off.	Make sure that the processor's Network port is securely connected to a computer, hub, or switch using a foiled or unshielded twisted-pair (F/UTP) Cat 5e cable (not included). Make sure that the computer's Ethernet connection is enabled. If it is disabled, the Link LED on the computer will probably be off. If the processor is connected to a hub or switch, make sure the Link LED on the hub or switch is on.
The Ethernet LED is on but devices cannot communicate with processor.	If you recently connected the processor to a power outlet, wait 40 seconds to make sure that the processor is fully turned on. The Power LED should be solid green. Make sure that the network settings on the TCP/IP Ethernet device you are using on the computer are set correctly: If you are not using a DHCP server, manually set the computer's IP address to an unused IP address (e.g. 192.168.0.2). The default IP subnet mask should be set to 255.255.255.0 . Open the firewall settings on the computer, and unblock all ports. Make sure that there is not another processor connected with the same address. If you are not sure, disconnect a processor, scan for the other processor, and then change its address. Repeat with the second processor.

Technical Information

Technical Specifications

CSP-428

Integrated DSP	
Signal Process/CPU	32-bit fixed/floating-point DSP + Arm® processor, 456 MHz
Maximum Calculation	3.6 GIPS / 2.7 GFLOPS
Audio Latency	900 μs (analog in to analog out)
A/D and D/A Converters	24-bit
Sample Rate	48 kHz
Audio Performance	
Frequency Response	20 Hz to 20 kHz (±0.5 dB)
THD+N	< 0.01% at +4 dBu (A-weighted/20 Hz to 20 kHz)
Channel Separation (Crosstalk)	< -105 dB at +4 dBu input and output level, 1 kHz
Dynamic Range	115 dB A-weighted 20 Hz to 20 kHz, analog through, 600 Ω load
Audio Inputs	
Inputs (balanced)	2 analog (balanced, Mic/Line Level/Page-In)
Inputs (unbalanced)	2 analog (unbalanced, RCA Line-In, summed to mono)
Connectors, Input	Balance Input: green 3.81 mm pitch (3-pin/6-pin) Page-In: green 3.81 mm pitch (4-pin) Unbalanced Input: red/white RCA connector
Input Impedance	12 kΩ at 1 kHz (with or without phantom power active)
Maximum Input Level	+24 dBu (THD+N ≤0.3%, 20 Hz to 20 kHz, 0 dB gain)
Equivalent Input Noise	< -117 dBu (22 Hz to 20 kHz, 150 Ω input, 64 dB gain)
Phantom Power	+48V, open circuit, 10 mA max per channel, selectable per input, 80 mA max across all channels
Pre-Gain Settings	0/14/24/32/44/54/64 dB
Audio Outputs	
Outputs	2 analog (balanced, Line Level), 8 digital (AmpLink output)
Connectors, Output	Analog Output: orange 3.81 mm pitch (6-pin) Digital Output: RJ-45 without LED (AmpLink output)
Output Impedance	66 Ω
Maximum Output Level	+24 dBu (THD+N ≤0.3%, 22 Hz to 20 kHz)
Control Inputs	
Inputs (Control)	8 analog inputs, 2 kΩ internal pull-up resistor to 5 V, green 3.81 mm pitch connector (9-pin)
Mute (Control)	1 analog input, 2 kΩ internal pull-up resistor to 5 V, black 3.81 mm pitch connector (2-pin)
Analog Input Voltage	0 V to 3.3 V (maximum 5 V)
Digital Input Voltage	0 V to 3.3 V (threshold voltage = 1.6 V)
Control Outputs	
Outputs (Control)	1 digital output, orange 3.81 mm pitch connector (2-pin)
Output Voltage	High: 8 V (open circuit), 2.5 V at 10 mA, Low: < 1 V at 100 mA, push-pull
Output Current	10 mA source, 100 mA sink (24 VDC max external supply voltage)

Indicators and Controls	
LED Status Indicators	Power/Status, Signal, Ethernet, AmpLink
Audio Signal Indication	Green (-60 to -20 dBFS), yellow (-20 to -2 dBFS), red (-2 dBFS to Clip)
Electrical	
Mains Voltage	85 VAC to 264 VAC, 50/60 Hz
AC Power Consumption	< 30 W typical, over all mains voltages, (PSU Max < 45 W)
Mains Connector	IEC 60320-C14 (inlet)
Power Dissipation	~22 W (75 BTU/Hr, 19 kcal/hr)
Physical	
Dimensions (H × W × D)	44 mm × 483 mm × 215 mm (1.7 in × 19.0 in × 8.5 in)
Operating Temperature	0 °C to 40 °C (32 °F to 104 °F)
Cooling System	Active, side venting with fan
Storage Temperature	-40 °C to 70 °C (-40 °F to 158 °F)
Humidity	80% (without condensation)
General	
Configuration Software	Integrated web server with configuration utility
Network Control	Ethernet (RJ-45), 10/100MBase-T

CSP-1248

Integrated DSP	
Signal Process/CPU	32-bit fixed/floating-point DSP + Arm®, 456 MHz
Maximum Calculation	3.6 GIPS / 2.7 GFLOPS
Audio Latency	900 μs (analog in to analog out)
A/D and D/A Converters	24-bit
Sample Rate	48 kHz
Audio Performance	
Frequency Response	20 Hz to 20 kHz (±0.5 dB)
THD+N	< 0.01% at +4 dBu (A-weighted/20 Hz to 20 kHz)
Channel Separation (Crosstalk)	< -105 dB at +4 dBu input and output level, 1 kHz
Dynamic Range	115 dB A-weighted 20 Hz to 20 kHz, analog through, 600 Ω load
Audio Inputs	
Inputs (balanced)	8 analog (balanced, Mic/Line Level/Page-In)
Inputs (unbalanced)	4 analog (unbalanced, RCA Line-In, summed to mono)
Connectors, Input	Balance Input: green 3.81 mm pitch (3-pin/6-pin) Page-In: green 3.81 mm pitch (4-pin) Unbalanced Input: red/white RCA connector
Input Impedance	12 kΩ at 1 kHz (with or without phantom power active)
Maximum Input Level	+24 dBu (THD+N ≤0.3%, 20 Hz to 20 kHz, 0 dB gain)
Equivalent Input Noise	< -117 dBu (22 Hz to 20 kHz, 150 Ω input, 64 dB gain)
Phantom Power	+48V, open circuit, 10 mA max per channel, selectable per input, 80 mA max across all channels
Pre-Gain Settings	0/14/24/32/44/54/64 dB
Audio Outputs	
Outputs	2 analog (balanced, Line Level), 8 digital (AmpLink output)
Connectors, Output	Analog Output: orange 3.81 mm pitch (6-pin) Digital Output: RJ-45 without LED (AmpLink output)
Output Impedance	66 Ω
Maximum Output Level	+24 dBu (THD+N ≤0.3%, 22 Hz to 20 kHz)
Control Inputs	
Inputs (Control)	8 analog inputs, 2 kΩ internal pull-up resistor to 5 V, green 3.81 mm pitch connector (9-pin)
Mute (Control)	1 analog input, 2 kΩ internal pull-up resistor to 5 V, black 3.81 mm pitch connector (2-pin)
Analog Input Voltage	0 V to 3.3 V (maximum 5 V)
Digital Input Voltage	0 V to 3.3 V (threshold voltage = 1.6 V)
Control Outputs	
Outputs (Control)	1 digital output, orange 3.81 mm pitch connector (2-pin)
Output Voltage	High: 8 V (open circuit), 2.5 V at 10 mA, Low: < 1 V at 100 mA, push-pull
Output Current	10 mA source, 100 mA sink (24 VDC max external supply voltage)
Indicators and Controls	
LED Status Indicators	Power/Status, Signal, Ethernet, AmpLink
Audio Signal Indication	Green (-60 to -20 dBFS), yellow (-20 to -2 dBFS), red (-2 dBFS to Clip)

Electrical	
Mains Voltage	85 VAC to 264 VAC, 50/60 Hz
AC Power Consumption	< 30 W typical, over all mains voltages, (PSU Max < 45 W)
Mains Connector	IEC 60320-C14 (inlet)
Power Dissipation	~22 W (75 BTU/Hr, 19 kcal/hr)
Physical	
Dimensions (H × W × D)	44 mm × 483 mm × 215 mm (1.7 in × 19.0 in × 8.5 in)
Operating Temperature	0 °C to 40 °C (32 °F to 104 °F)
Cooling System	Active, side venting with fan
Storage Temperature	-40 °C to 70 °C (-40 °F to 158 °F)
Humidity	80% (without condensation)
General	
Configuration Software	Integrated web server with configuration utility
Network Control	Ethernet (RJ-45), 10/100MBase-T



814842-0010

©2018 Bose Corporation, All rights reserved.
Framingham, MA 01701-9168 USA
PRO.BOSE.COM
AM814842 Rev. 00
December 2018

