

***BOSE***<sup>®</sup>

# L1<sup>®</sup> Compact

---

## Portable Line Array System

Owner's Guide

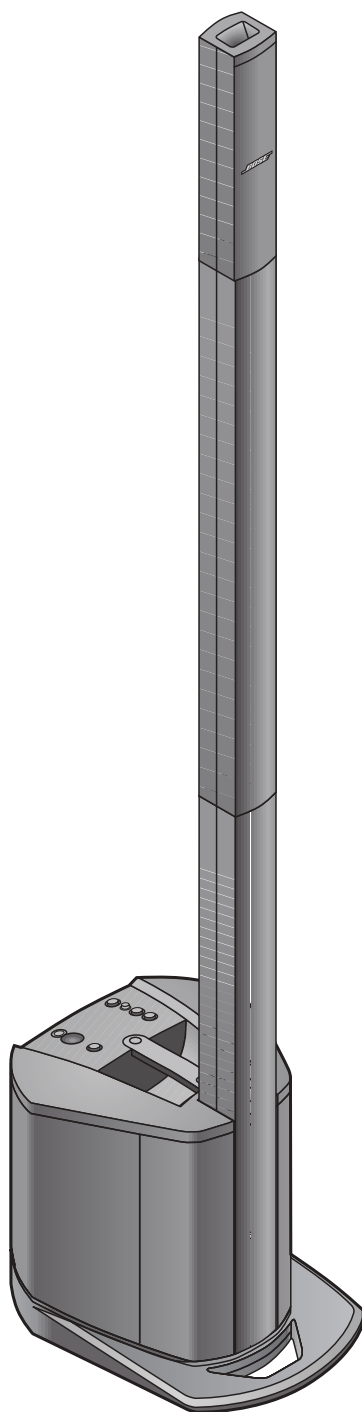

# Quick setup guide

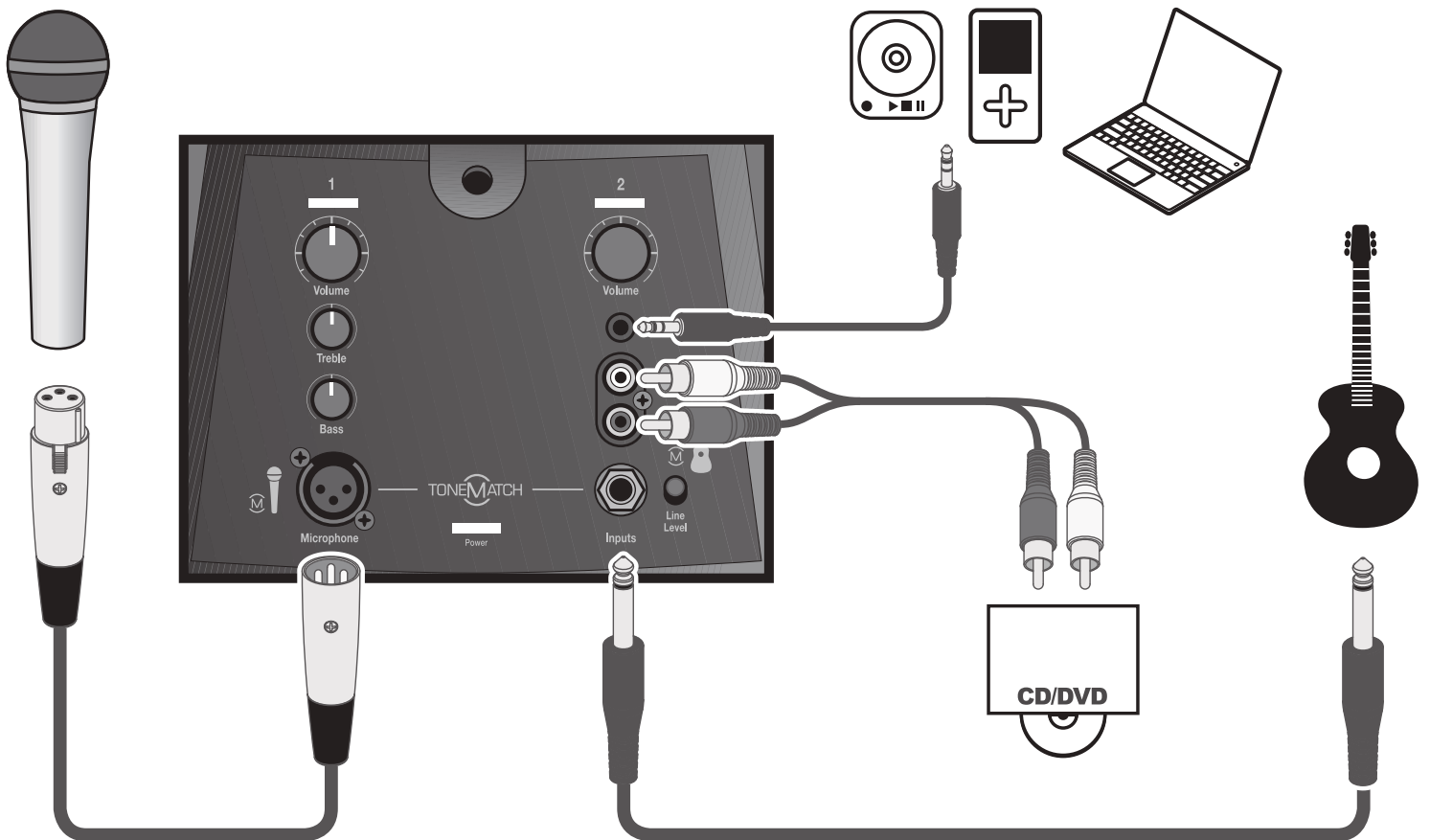

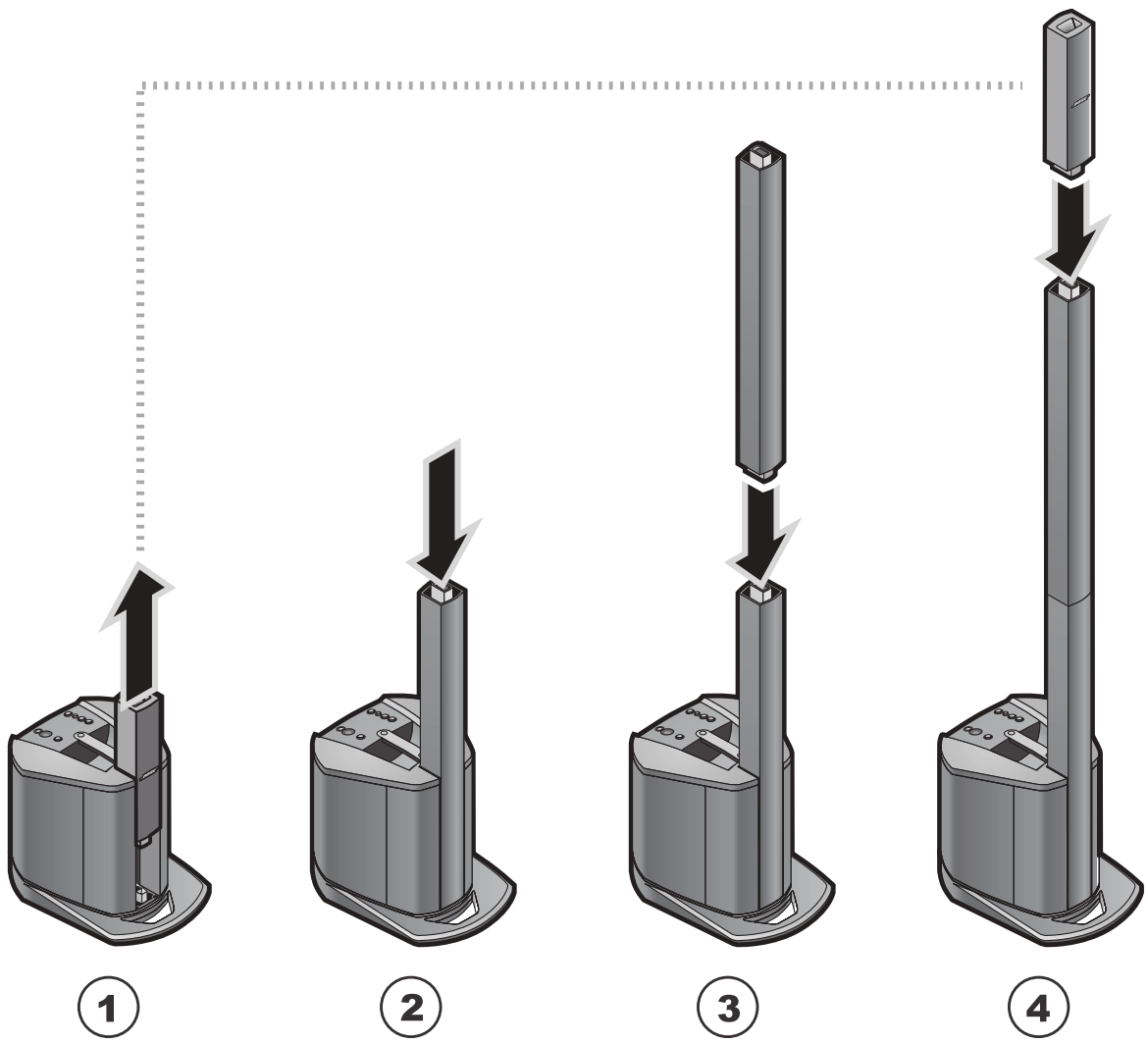





# SAFETY INFORMATION



## **Please read this owner's guide**

Please take the time to follow the instructions in this owner's guide carefully. It will help you set up and operate your system properly and enjoy its advanced features. Please save this owner's guide for future reference.

 **WARNING:** To reduce the risk of fire or electrical shock, do not expose the system to rain or moisture.

 **WARNING:** To reduce the risk of electric shock, do not disassemble this system unless you are qualified. Refer servicing to qualified service personnel.

	<b>CAUTION</b> RISK OF ELECTRICAL SHOCK DO NOT OPEN	
CAUTION: TO REDUCE THE RISK OF ELECTRIC SHOCK, DO NOT REMOVE COVER (OR BACK). NO USER-SERVICABLE PARTS INSIDE. REFER SERVICING TO QUALIFIED PERSONNEL.		

	<b>AVIS</b> RISQUE DE CHOC ÉLECTRIQUE NE PAS OUVRIR	
ATTENTION : POUR RÉDUIRE LE RISQUE DE DÉCHARGE ÉLECTRIQUE, NE RETIREZ PAS LE COUVERCLE (OU L'ARRIÈRE). IL NE SE TROUVE À L'INTÉRIEUR AUCUNE PIÈCE POUVANT ÊTRE RÉPARÉE PAR L'USAGER. S'ADRESSER À UN RÉPARATEUR COMPÉTENT.		

 The lightning flash with arrowhead symbol within an equilateral triangle alerts the user to the presence of uninsulated, dangerous voltage within the system enclosure that may be of sufficient magnitude to constitute a risk of electrical shock.

 The exclamation point within an equilateral triangle, as marked on the system, is intended to alert the user to the presence of important operating and maintenance instructions in this owner's guide.

 **CAUTION:** This product shall be connected to a mains socket outlet with a protective earthing connection.

 **CAUTION:** Make no modifications to the system or accessories. Unauthorized alterations may compromise safety, regulatory compliance, and system performance.

 **CAUTION:** Do not place any naked flame sources, such as lighted candles, on or near the apparatus.

 **CAUTION:** Where the mains plug is used as the disconnect device, such disconnect device shall remain readily operable.

**Note:** The product must be used indoors. It is neither designed nor tested for use outdoors, in recreation vehicles, or on boats.

 This product conforms to the EMC Directive 2004/108/EC and to the Low Voltage Directive 2006/95/EC. The complete Declaration of Conformity can be found at [www.Bose.com/static/compliance/index.html](http://www.Bose.com/static/compliance/index.html).

 **WARNING:** Do not expose this apparatus to dripping or splashing and do not place objects filled with liquids, such as vases, on or near the apparatus. As with any electronic products, use care not to spill liquids into any part of the system. Liquids can cause a failure and/or a fire hazard.

### **Japan only:**

**Note:** Provide an earth connection before the main plug is connected to the mains.

# IMPORTANT SAFETY INSTRUCTIONS

1. Read these instructions.
2. Keep these instructions.
3. Heed all warnings.
4. Follow all instructions.
5. Do not use this apparatus near water.
6. Clean only with a dry cloth.
7. Do not block any ventilation openings. Install in accordance with the manufacturer's instructions.
8. Do not install near any heat sources, such as radiators, heat registers, stoves, or other apparatus (including amplifiers) that produce heat.
9. Do not defeat the safety purpose of the polarized or grounding-type plug. A polarized plug has two blades with one wider than the other. A grounding-type plug has two blades and a third grounding prong. The wider blade or third prong is provided for your safety. If the provided plug does not fit into your outlet, consult an electrician for replacement of the obsolete outlet.
10. Protect the power cord from being walked on or pinched, particularly at plugs, convenience receptacles, and the point where they exit from the apparatus.
11. Only use attachments/accessories specified by the manufacturer.
12. Use only with the cart, stand, tripod, bracket, or table specified by the manufacturer or sold with the apparatus. When a cart is used, use caution when moving the cart/apparatus combination to avoid injury from tip-over. 
13. Unplug this apparatus during lightning storms or when unused for long periods of time.
14. Refer all servicing to qualified service personnel. Servicing is required when the apparatus has been damaged in any way, such as power-supply cord or plug is damaged, liquid has been spilled or objects have fallen into the apparatus, the apparatus has been exposed to rain or moisture, does not operate normally, or has been dropped.
15. To prevent risk of fire or electric shock, avoid overloading wall outlets, extension cords, or integral convenience receptacles.
16. Do not let objects or liquids enter the product – as they may touch dangerous voltage points or short-circuit parts that could result in a fire or electric shock.
17. See product enclosure for safety-related markings.
18. Use proper power sources – Plug the product into a proper power source, as described in the operating instructions or as marked on the product.
19. Apparatus shall not be exposed to dripping or splashing, and no objects filled with liquids, such as vases, shall be placed on the apparatus.
20. No naked flame source, such as lighted candles, should be placed on or near the apparatus.
21. **Power LED** – Indicates power status.  
Blue: Power on.

## Information about products that generate electrical noise

This equipment has been tested and found to comply with the limits for a Class A digital device, pursuant to Part 15 of the FCC rules. These limits are designed to provide reasonable protection against harmful interference in a commercial environment. This equipment generates, uses, and can radiate radio frequency energy and, if not installed and used in accordance with the instructions, may cause harmful interference to radio communications. Operation of this equipment in a residential area is likely to cause harmful interference, in which case the user will be required to correct the interference at his own expense.

This product complies with the Canadian ICES-003 Class A specifications.

# CONTENTS

---

## INTRODUCTION 1

Welcome .....	1
Features and benefits .....	1
Product overview .....	2

## SYSTEM SETUP 3

System configurations .....	3
Setting up the system .....	4
Setting up in the collapsed position .....	4
Setting up in the extended position .....	4
Extending the Loudspeaker Array .....	5
Connecting power to the system .....	5

## OPERATING INFORMATION 6

Connections and controls .....	6
Rear panel outputs .....	7
Plugging in your sources .....	7
Setting the Channel 1 (microphone) controls .....	8
Setting the Channel 2 controls .....	8
Applying the acoustic guitar ToneMatch® preset .....	9
Connection scenarios .....	9
Classroom .....	9
Presentations .....	10
Solo musical performances .....	11
DJ events .....	11
Advanced setup using the T1 ToneMatch® audio engine .....	12
Single musician .....	12
Multiple musicians .....	13
Mixed setup .....	13

## CARE AND MAINTENANCE 14

Caring for your product .....	14
Cleaning .....	14
Troubleshooting .....	14
Bose® Community Message Board .....	15
Getting service .....	15
Accessories .....	15
Limited Warranty and Registration .....	16
What you must do to obtain Limited Warranty Service: .....	16
Technical Information .....	17
Mechanical .....	17
Electrical .....	17
Audio Input/Output .....	17

## **Welcome**

Thank you for purchasing the Bose® L1® *Compact* Portable Line Array System. Whether you are a musician amplifying your instruments, a mobile DJ entertaining an audience, or the host of your own special event, this system will provide quality sound for audiences of approximately 100 people.

This owner's guide provides detailed setup and operating instructions for your L1® *Compact* system and explains how to connect to a variety of audio sources. For additional information on using this system, including tips, techniques, and frequently asked questions, please visit [www.Bose.com/musicians](http://www.Bose.com/musicians) on the Internet.

## **Features and benefits**

- **Carry it in one trip** – The entire system is light enough to be carried in a single trip.
- **Set it up in one minute** – The interlocking components of the L1® *Compact* system allow system setup in less than a minute. There are no external speaker wires required. An integrated bass enclosure with an intuitive user interface eliminates the need for separate components.
- **Fill the room with one loudspeaker** – Whether you're performing live or playing back prerecorded music, whether you're performing in a coffeehouse or a 100-seat room, Bose® Spatial Dispersion™ loudspeaker technology provides nearly 180° of tonally balanced sound coverage so there are no dead spots.
- **PA and monitor combined** – Audience members enjoy a more consistent and intimate listening experience because the system sets up behind the performer and serves as both the monitor for the stage and amplification system for the audience. The performer alone controls the sound.
- **Versatility** – In addition to musical performances, the L1® *Compact* provides quality sound for a wide variety of general-purpose uses including presentations, celebrations, speeches, and music playback for about 100 people.
- **Integrated ToneMatch® signal processing** – Provides a high level of tone customization on your microphone or instrument to provide a listening experience that most musicians only achieve using a recording studio.
- **Two setup options** – The L1® *Compact* system can be used in either the collapsed position for smaller audiences or extended positions for larger audiences.

## Product overview



The L1<sup>®</sup> Compact Portable Line Array System is shipped in two cartons. Carefully unpack the cartons and check that you have all the items listed on this page.

**WARNING:** To avoid danger of suffocation, keep the plastic bags out of the reach of children.

The L1<sup>®</sup> Compact system consists of:

- L1<sup>®</sup> Compact Power Stand
- L1<sup>®</sup> Compact Loudspeaker Array
- L1<sup>®</sup> Compact Extensions

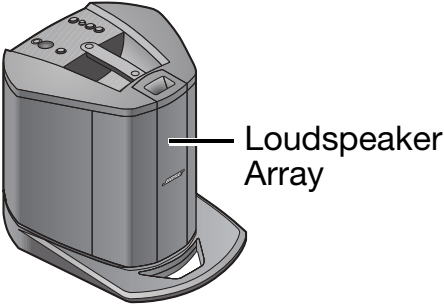
The L1<sup>®</sup> Compact system comes with a slipcover for the Power Stand and a padded carry bag for the L1<sup>®</sup> Compact Extensions.

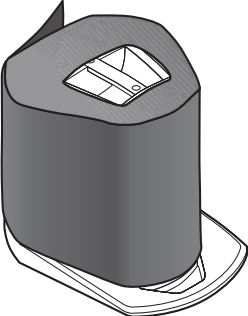
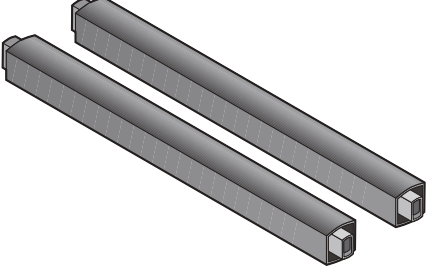
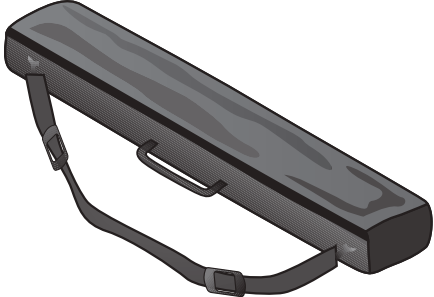
Power stand carton	Extensions carton
<p data-bbox="280 931 646 994">L1<sup>®</sup> Compact Power Stand with Loudspeaker Array</p>  <p data-bbox="280 1339 488 1370">AC power cord</p>  <p data-bbox="280 1532 588 1563">Power Stand slipcover</p> 	<p data-bbox="815 931 1153 963">L1<sup>®</sup> Compact Extensions</p>  <p data-bbox="815 1344 1102 1375">Extensions carry bag</p> 

For a complete list of optional equipment and accessories, please visit: [www.Bose.com/musicians](http://www.Bose.com/musicians).



## System configurations

You can set up the versatile L1® Compact system in two unique positions. The examples below will help you quickly identify the position that can work best for you.

### Collapsed position

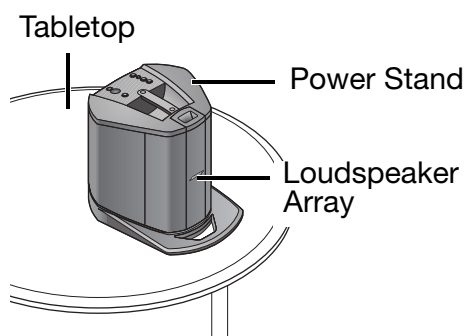

#### Smaller audiences

- Intimate acoustic performances
- Music playback
- Presentations
- Speeches

### Extended position

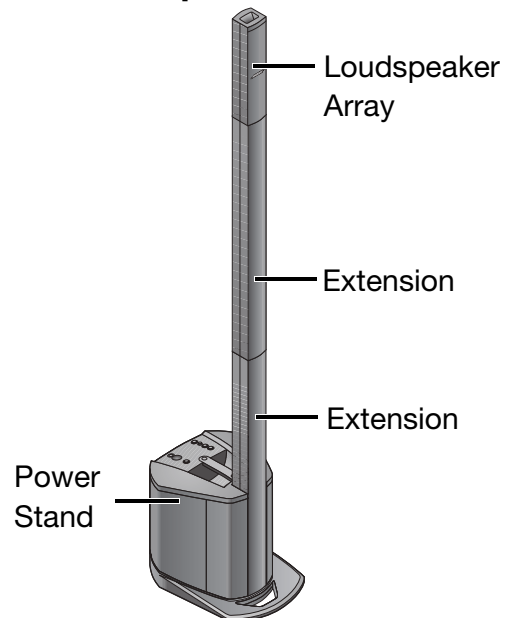

#### Larger audiences

- Musical performances – auditorium/coffeehouse
- DJ events
- Announcements – larger spaces

The L1® Compact Extensions are not required when using the L1® Compact Portable Line Array System in the collapsed position. They are included for situations where you need to elevate the Loudspeaker Array to project sound to larger audiences.

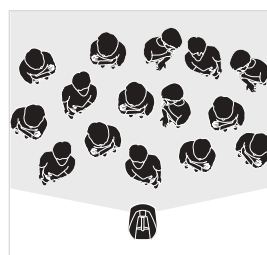
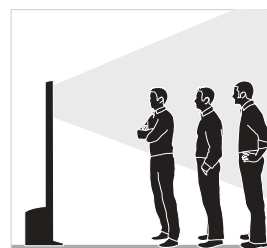
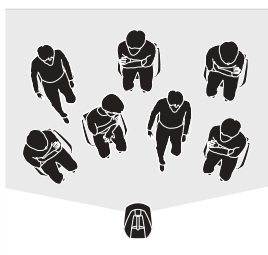
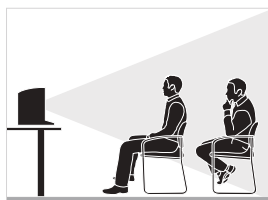

### ***Setting up the system***

Before making any connections, you should set the L1® *Compact Portable Line Array System* up either in the collapsed position (the system is shipped in the collapsed position) or the extended position.

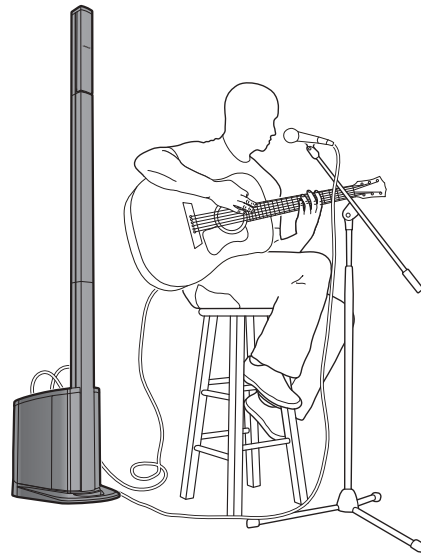
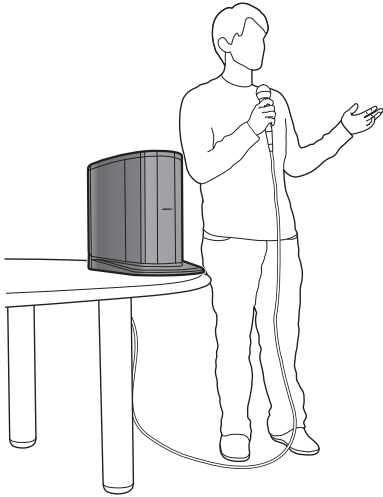

#### ***Setting up in the collapsed position***

To get the most sound quality and ensure that seated audience members enjoy the full frequency range of the system, position it on a table (shown above) at ear-level or at the front edge of a stage (not shown). This will allow sound to project clearly and evenly throughout the audience.

#### ***Setting up in the extended position***

In larger rooms, or with larger audiences where the sound could be blocked by obstacles, it is best to set up the L1® *Compact Portable Line Array System* in the extended position.

### Extending the Loudspeaker Array

Once you have set the system in place:

1. Slide the Loudspeaker Array up and out of the Power Stand and temporarily lay it aside.

**Note:** The two L1® Compact Extensions are identical to each other. Either one can be used on the top or bottom, but if one extension is used, both must be used.

2. Align the plug on the bottom of the Extension with the socket on the Power Stand, then slide the extension into the power stand.

Be sure to fully insert the extension into the Power Stand socket to assure stability and a good connection.



3. Align the remaining Extension and push it firmly in place.
4. Align the Loudspeaker Array and push it firmly in place.

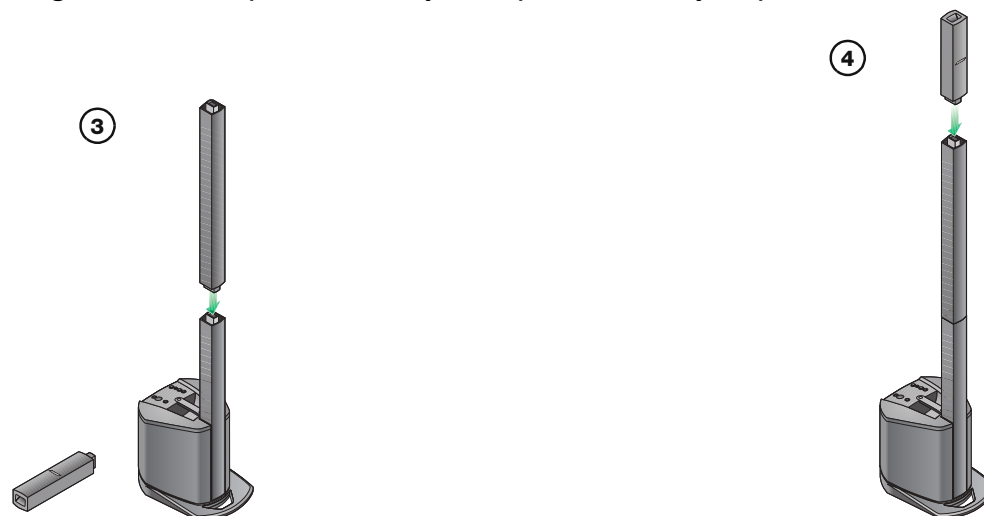

### Connecting power to the system

1. Make sure the power switch is off (down position).
2. Plug one end of the power cord into the connector on the power stand.
3. Plug the other end into a live electrical receptacle.

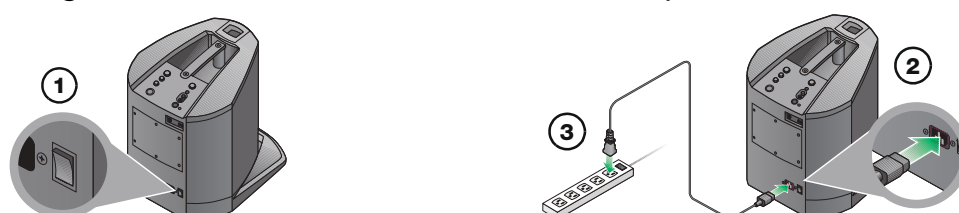

4. Before turning the system on, connect your sound sources. See “Operating Information” on page 6, and “Plugging in your sources” on page 7.

# OPERATING INFORMATION

## Connections and controls

The power stand control panel provides all the necessary connectors, controls, and indicators for operation.



### Channel 1 (Microphone input)

**The channel 1 input is for use only with a microphone.** Integrated ToneMatch® signal processing provides a high level of tone customization to provide a listening experience that most musicians can only achieve using a recording studio.

- 1. Signal/Clip indicator** – Displays the input signal status in color.
  - Green: Input signal present
  - Red: Input signal clipping
- 2. Volume control** – Adjusts the volume of your microphone.
- 3. Treble control** – Adjusts the amount of treble on your microphone.
- 4. Bass control** – Adjusts the amount bass on your microphone.
- 5. Microphone input** – Analog input for connecting a balanced XLR microphone cable. A ToneMatch® microphone preset is built in.

### Channel 2 (Utility channel – multiple input)

- 6. Signal/Clip indicator** – Displays the input signal status in color.
  - Green: Input signal present
  - Red: Input signal clipping
- 7. Volume control** – Adjusts the overall volume of all input sources connected to Channel 2.
- 8. 1/8-inch stereo input** – Balanced analog input for connecting audio sources such as portable mp3 players, satellite radio, laptop computers, video projectors, and smart boards.
- 9. RCA stereo input** – Analog input for connecting audio sources such as DVD players, VCR players, video game consoles, DJ mixers, Keyboards and other instruments. For best results, connect both the left and right signals.
- 10. 1/4-inch input** – Balanced analog input for connecting guitars and other instruments. Accepts either 1/4-inch TRS balanced or TS unbalanced cables.
- 11. ToneMatch® switch** – When connecting an acoustic guitar to the 1/4-inch input, move the switch to the  position to enable a ToneMatch® preset. When connecting anything other than an acoustic guitar to the 1/4-inch input, move the switch down to the Line Level position.
- 12. Power LED** – Indicates power status.
  - Blue: Power on

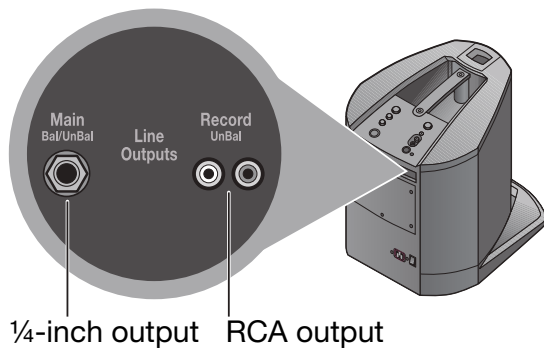

**Rear panel outputs**

**1/4-inch output** – Mono analog output that accepts either 1/4 inch TRS balanced or TS unbalanced cables. Can be used to link multiple L1® *Compact* systems together by connecting the 1/4-inch output from one L1® *Compact* system to the 1/4-inch input (Channel 2) on a second L1® *Compact* system. This will provide additional coverage in larger spaces. You can also use the 1/4-inch output to connect to a house PA system and use the L1® *Compact* system as your personal monitor.

**Note:** Using a TS unbalanced cable will result in a drop in the audio level of -6dBu.

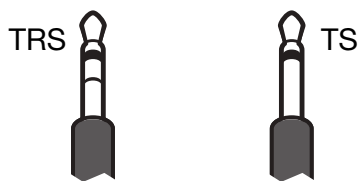

**RCA output** – Mono line level analog output for connecting audio devices such as CD recorders and flash recorders. For best results, connect both the left and right signals.

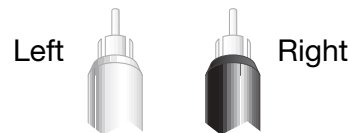

**Plugging in your sources**

Before plugging in a sound source, adjust the channel’s **Volume** control fully counterclockwise.

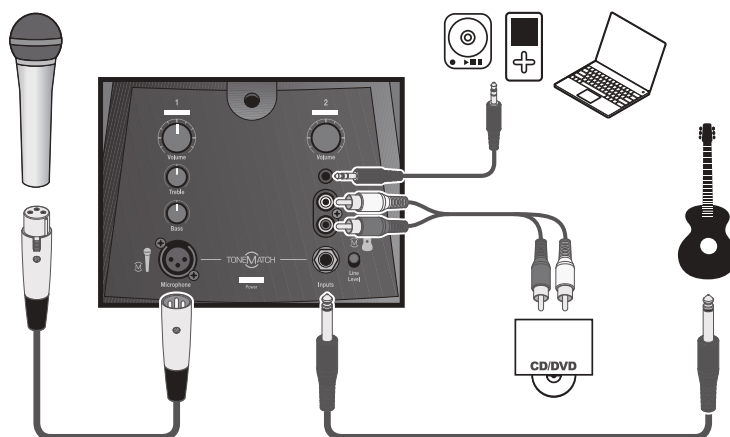

### Setting the Channel 1 (microphone) controls

Channel 1 is only intended for use with a dynamic handheld microphone. Do not connect any other sources to this input.

1. Before using the microphone, adjust the Channel 1 **Volume** control fully counterclockwise.
2. While speaking into the microphone, adjust the **Volume** control to the desired level.

For best results, keep the microphone close to your lips when speaking. Holding the microphone more than 3 inches (7.6 cm) away from your lips when speaking will lead to less overall volume and may impact overall clarity.

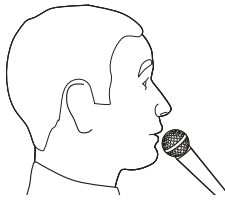

The Channel 1 Microphone Input is equipped with an integrated ToneMatch® preset to automatically optimize the sound of your microphone.

3. Adjust the **Treble** and **Bass** controls to make further refinements based on your personal preference.

### Setting the Channel 2 controls

When connecting an audio source to any of the Channel 2 inputs, follow these steps to adjust the volume.

1. On the power stand, adjust the Channel 2 **Volume** control fully counterclockwise.
2. Connect the audio source to the appropriate Channel 2 input.

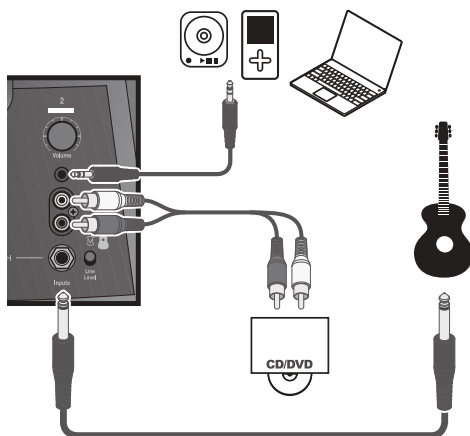

3. Turn the Channel 2 **Volume** control clockwise until the volume indicator glows green or yellow.

If the volume indicator steadily glows red, decrease the volume.

**Note:** You can connect multiple audio sources, one to each of the Channel 2 Inputs, at the same time. However, you must then adjust the volume on each source device to achieve the mix you desire.

### Applying the acoustic guitar ToneMatch® preset

You can access the ToneMatch® preset by plugging into the 1/4-inch input on Channel 2 and moving the ToneMatch® switch to the **M** position. The ToneMatch® preset is designed specifically for use with an acoustic guitar.

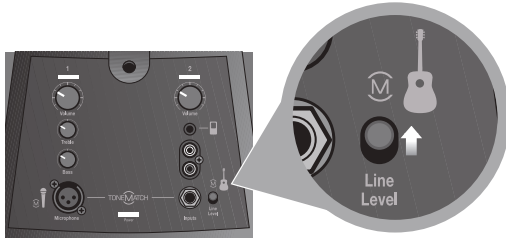

**Note:** The ToneMatch® preset switch only affects the 1/4-inch input. Sound from devices connected to the 1/8-inch stereo input and the RCA stereo input are not affected.

## Connection scenarios

There are many ways to connect and use the L1® Compact system. The following pages show a few examples of typical scenarios.

### Classroom

A typical setup scenario for a classroom could include a DVD player connected to the L1® Compact system.

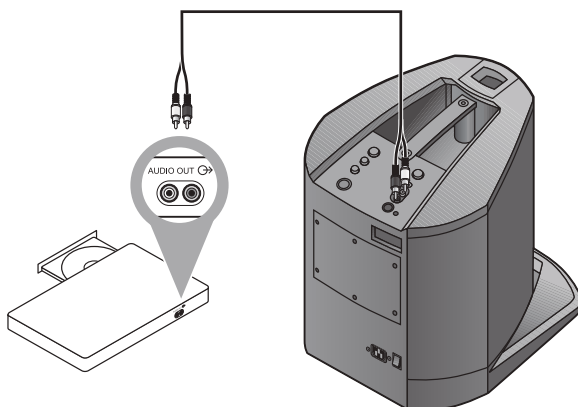

## OPERATING INFORMATION

### ***Presentations***

Connect the audio output from your laptop computer and deliver multimedia presentations.

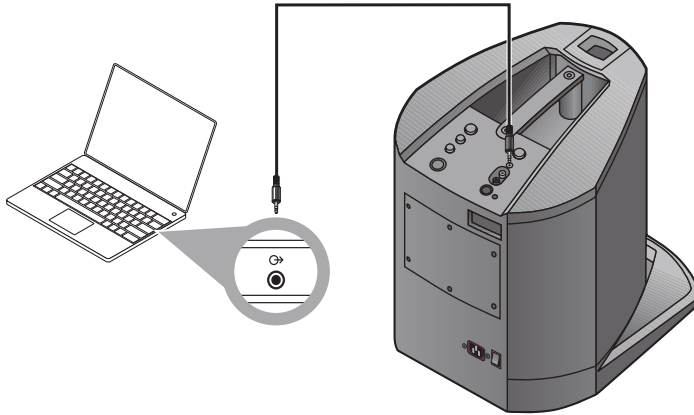

Within auditoriums, the setup could include two L1<sup>®</sup> Compact systems, several microphones, and a small mixer.

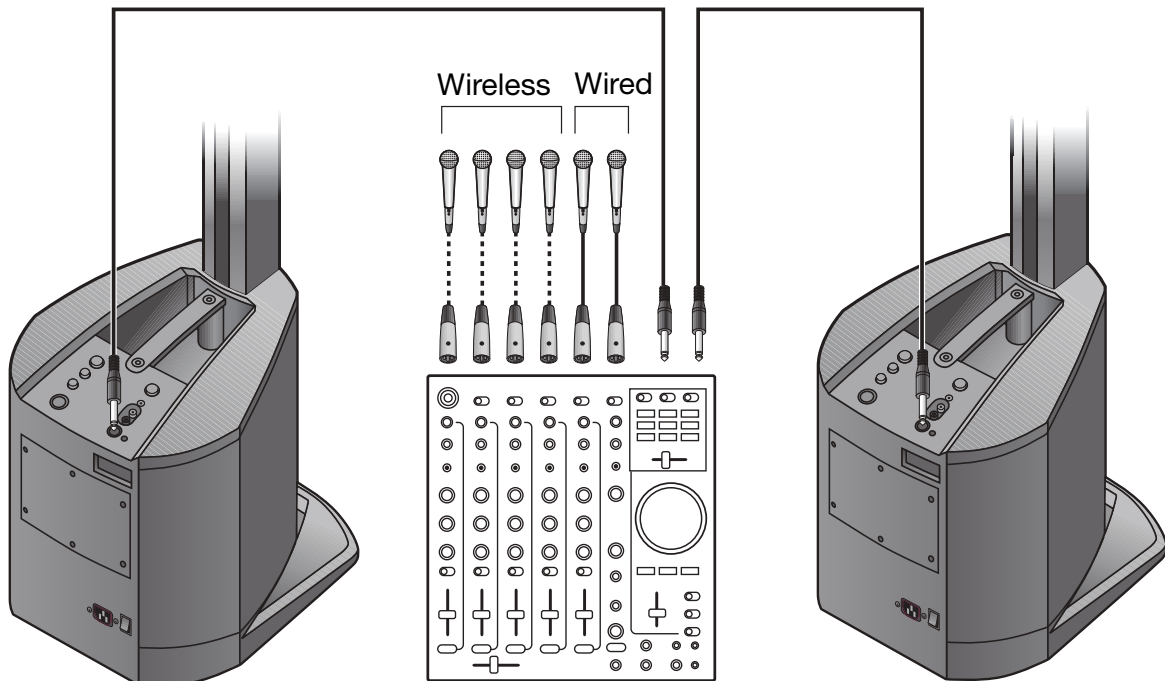



**Solo musical performances**

The multiple inputs on the L1® Compact system allow a soloist to connect a vocal microphone, musical instrument, and backing tracks.

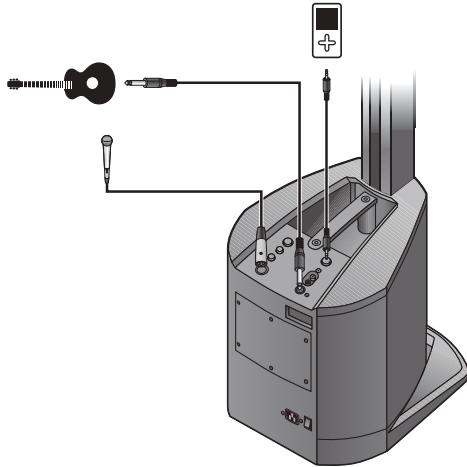

**DJ events**

DJs use multiple input sources (CD player, MP3 player, etc.) plugged into a mixer. In this scenario, two mixer outputs are fed into two L1® Compact systems for stereo sound.

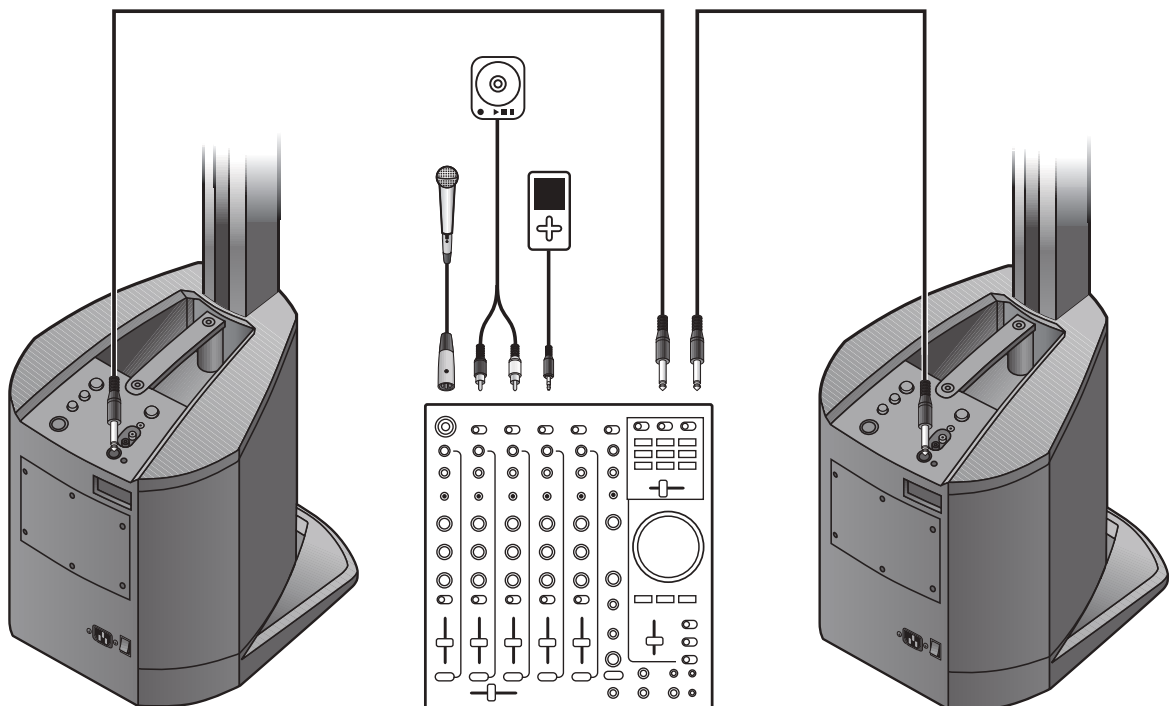

### **Advanced setup using the T1 ToneMatch® audio engine**

For more demanding performances, a musician can add the optional T1 ToneMatch® audio engine to his or her setup. The T1 offers expanded inputs and outputs, access to quality effects, dynamics processing, and our most advanced tone-shaping library. In addition, the T1 ToneMatch® audio engine provides additional input/output capabilities.

The optional T1 ToneMatch® audio engine requires the optional power supply. To learn more about the T1 ToneMatch® audio engine, please visit [www.Bose.com/musicians](http://www.Bose.com/musicians).

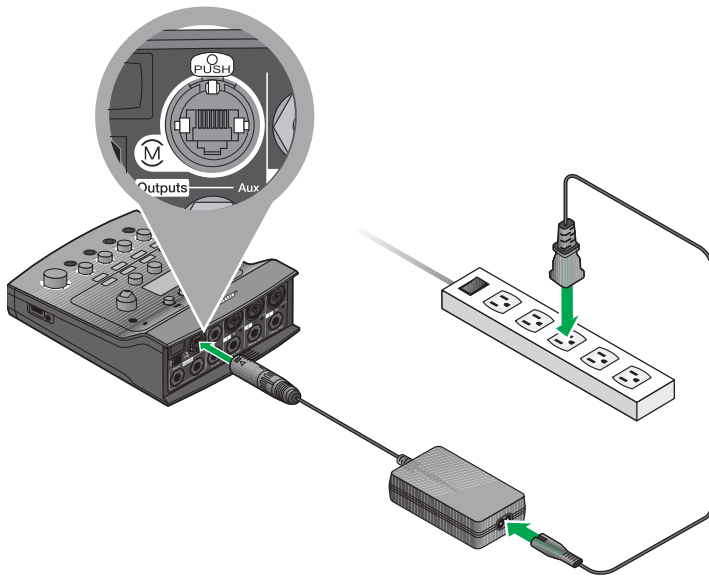

### **Single musician**

A single musician could add a microphone and T1 ToneMatch® audio engine to their setup.

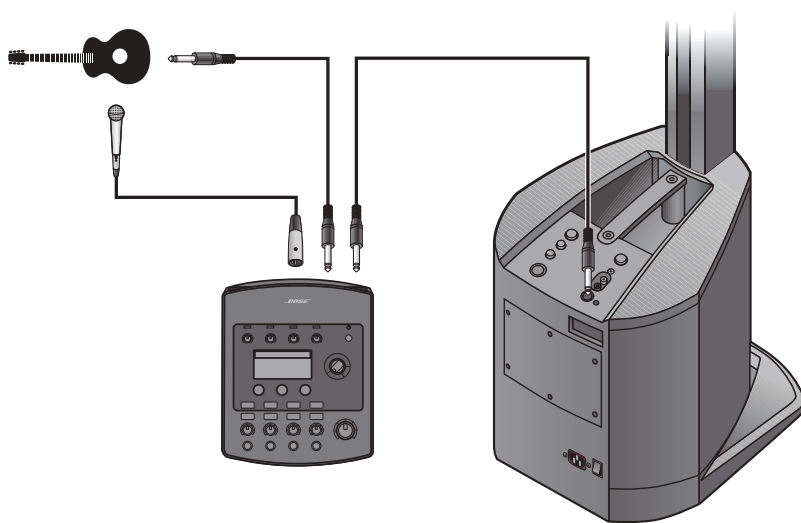

### Multiple musicians

In this scenario, a keyboard-guitar duo sings and plays through a single T1 ToneMatch® audio engine and an L1® Compact system.

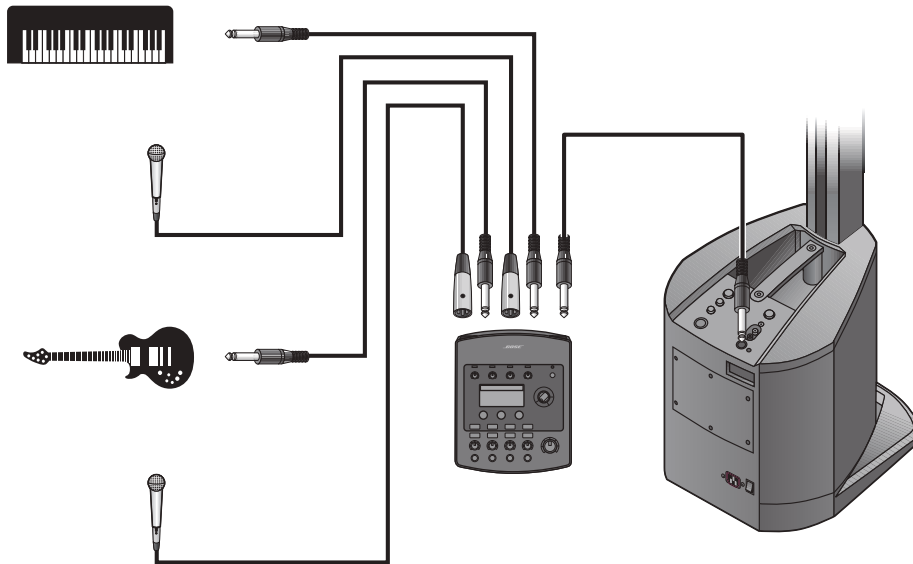

### Mixed setup

A more elaborate multiple musician setup could be as shown below. This scenario employs two L1® Compact systems and a T1 ToneMatch® audio engine.

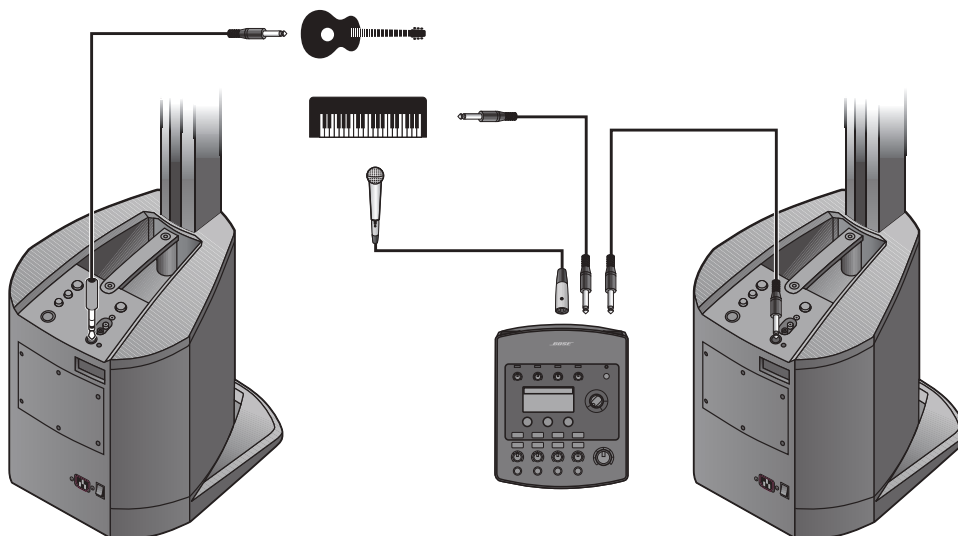

# CARE AND MAINTENANCE

## Caring for your product

### Cleaning

- Clean the product enclosures using only a soft, dry cloth.
- Do not use any solvents, chemicals, or cleaning solutions containing alcohol, ammonia, or abrasives.
- Do not use any sprays near the product or allow liquids to spill into any openings.
- If necessary, you may carefully vacuum the grille of the L1® Compact Power Stand.

## Troubleshooting

If you experience problems while using this product, try the following solutions.

### Recommended troubleshooting tools

- Spare AC power cord
- XLR and 1/4-inch phone plug cables

<b>Problem</b>	<b>What to do</b>
System is plugged in, power switch is on, but power LED is off	<ul style="list-style-type: none"><li>• Make sure you are using the included L1® Compact Power Stand power cable.</li><li>• Make sure the power cable is fully engaged into both the Power Stand and the AC outlet.</li><li>• Make sure you have power at the AC outlet. Try operating a lamp or other equipment from the same AC outlet.</li><li>• Try a different power cable.</li><li>• If available, try a different Power Stand.</li></ul>
Power LED is on, but no sound	<ul style="list-style-type: none"><li>• Make sure the <b>Volume</b> control is turned up on the Power Stand.</li><li>• Make sure the volume control is turned up on your instrument.</li><li>• Make sure your instrument or audio source is plugged into the appropriate input jack.</li><li>• Connect your instrument or audio source to the Power Stand using a different cable.</li></ul>
Middle to high frequencies absent from the L1® Compact Loudspeaker Array	<ul style="list-style-type: none"><li>• When in the collapsed position, always place the system on a tabletop so it is level with the listeners' ears.</li><li>• Make sure the L1® Compact Extensions and L1® Compact Loudspeaker Array are firmly seated in their connectors.</li><li>• Make sure connections are not bent or broken.</li><li>• Try cleaning the contacts on the loudspeaker top and bottom with electronic contact spray cleaner.</li></ul>
Instrument or audio source sounds distorted	<ul style="list-style-type: none"><li>• Lower the volume of the connected audio source.</li><li>• If you are connecting an external mixer, make sure the equalization controls for low, mid, and high on the mixer are set to mid position.</li><li>• Reduce the output of the mixer.</li></ul>
Microphone is encountering feedback	<ul style="list-style-type: none"><li>• Position the microphone so it is not pointing directly at its respective L1® Compact Loudspeaker array.</li><li>• Try positioning the microphone so it nearly touches your lips.</li><li>• Try a different microphone.</li><li>• Try a different position for the L1® Compact Portable Line Array System and/or vocalist on stage.</li><li>• Increase the distance from the loudspeaker to the microphone.</li><li>• If using a vocal effects processor, make sure it is not contributing to the feedback.</li></ul>

### ***Bose® Community Message Board***

To interact with other L1® product owners and for tips on getting the most out of your L1® *Compact* Portable Line Array System, please visit the Bose® Musicians Community Message Board at: <http://Bose.infopop.cc/eve>.

### ***Getting service***

For additional help in solving problems, contact the Bose® Live Music Customer Service Product and Technical Support Team at (877) 335-2673 or visit our support area online at [www.Bose.com/musicians](http://www.Bose.com/musicians).

### ***Accessories***

Visit [www.Bose.com/musicians](http://www.Bose.com/musicians), or call (800) 905-0886 for accessory information.

## **Limited Warranty and Registration**

Your L1® *Compact* Portable Line Array System is covered by a limited transferable warranty. Details of the limited warranty are provided on the product registration card that is included in the carton. Please refer to the card for instructions on how to register. Failure to register will not affect your limited warranty rights.

### **What you must do to obtain Limited Warranty Service:**

Return product, with proof of purchase from an authorized Bose® dealer, using the following procedures:

1. Contact the Bose organization in your country/region (visit [Global.Bose.com](http://Global.Bose.com) for Bose contact information in your country/region) for specific return and shipping instructions;
2. Label and ship the product, freight prepaid, to the address provided by the authorized service facility; and
3. Place any necessary return authorization number prominently on the outside of the carton. Cartons not bearing a return authorization number, where required, will be refused.

The L1® *Compact* Portable Line Array System is covered by patents issued or pending in the U.S. and other countries.

#### **Serial numbers and product registration**

Now is a good time to record the serial numbers of your system here and on your product registration card.

L1® *Compact* Loudspeaker Array \_\_\_\_\_

L1® *Compact* Power Stand \_\_\_\_\_

L1® *Compact* Extensions \_\_\_\_\_

Bose recommends that you keep your sales receipt together with this guide.

## Technical Information

### Mechanical

<b>Part</b>	<b>Dimensions</b>	<b>Weight</b>
L1® Compact Power Stand with Loudspeaker Array	16½" H x 13¼" W x 16¾" D (41.8 cm x 33.9 cm x 42.6 cm)	24.6 lbs. (11.2 kg)
L1® Compact Loudspeaker Array	16" H x 2¾" W x 2¾" D (40.8 cm x 7 cm x 7.1 cm)	3.0 lbs. (1.35 kg)
L1® Compact Extensions (2)	32½" H x 2¾" W x 2¾" D (83 cm x 7 cm x 7.1 cm)	2.3 lbs. (1.05 kg) each
Collapsed position (assembled)	16½" H x 13¼" W x 16¾" D (41.8 cm x 33.9 cm x 42.6 cm)	24.6 lbs. (11.2 kg)
Extended position (assembled)	78½" H x 13¼" W x 16¾" D (199.5 cm x 33.9 cm x 42.6 cm)	29.2 lbs. (13.3 kg)

### Shipping Cartons

	<b>Weight</b>
L1® Compact loudspeakers	30.4 lbs. (13.8 kg)
L1® Compact extensions	7.5 lbs. (3.4 kg)

### Electrical

- AC power rating  
100-240V ~ 50/60Hz 200W max
- Peak inrush current  
230V: 18.2 Amps  
120V: 9.7 Amps

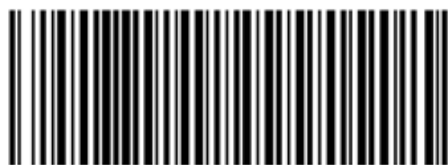

317638-0010