

# **MA**

**Digital Vertical Array**

# **T8**

**MANUALE D'USO - Sezione 1**  
**USER MANUAL - Section 1**  
**BEDIENUNGSANLEITUNG - Abschnitt 1**  
**CARACTERISTIQUES TECHNIQUES - Section 1**



**Made in Italy**

## DESCRIPTION

The DVA T8 is equipped with three class D amplifiers of DIGIPRO® G2 series, high efficiency, which delivers high output power in a compact size and low weight. Thanks to its high efficiency the cooling of the amplifier module is obtained statically, thus avoiding the use of a fan.

The power supply circuits of the DIGIPRO® G2 amplifier has been conceived to work in full-range mode; thanks to the SMPS (Switched-Mode Power Supplies) technology with PFC (Power Factor Correction) the operation with supply voltages between 100 Vac and 240Vac is guaranteed by ensuring the same sound performances even with floating and non-stabilized power supply systems.

The amplifier module is able to deliver 350W (RMS) for the bass section, 175W (RMS) for the mid-section and 175W (RMS) for the treble section.

The bass section controls a 8" neodymium woofer (2.5" voice coil) guarantees a high SPL and the obtainment of frequencies of up to 70Hz.

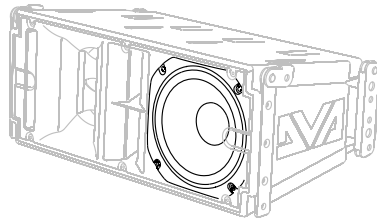

The mid-section controls one 6.5" neodymium midranges (2" voice coil), enclosed in its own acoustic chamber and horn loaded with a power factor corrector. The plug phases located in front of the cones prevent the vertical phases from overlapping, creating in fact a local array with 3 output slot that increases directivity. The horn design was specifically created to couple it correctly with the DVA T4 and DVA T12 modules.

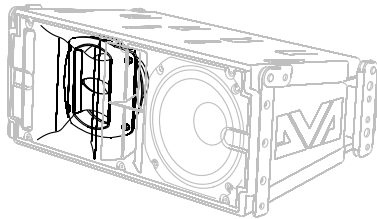

The treble section controls two 1" neodymium drivers (1.4" voice coil) positioned vertically and spaced to optimize the vertical cover. The horn design was specifically created to couple it correctly with the DVA T4 and DVA T12 modules.

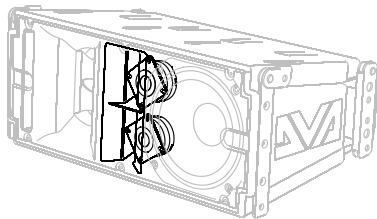

This specific design has made it possible to obtain a constant and precise 100° coverage in a horizontal direction and 15° coverage in a vertical director for each diffuser.

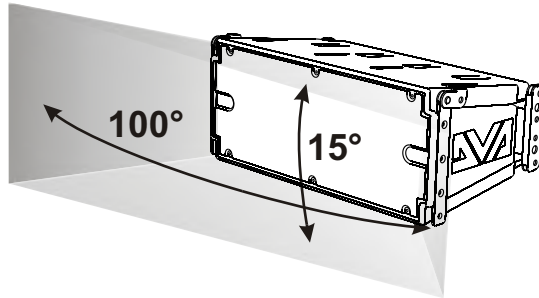

### DVA Network

DVA T8 is equipped with proprietary network interface, called RDNET, for PC interface through a device (RDNET control).

For this purpose, a proprietary communication protocol has been developed for receiving and sending data; this connection permits real-time monitoring of the diffuser parameters, such as output power, amplifier temperature, limiter status, etc...

It is also possible to select various equalizations or create new ones, set the desired volume levels using the specific plug-in.



It is recommended to download DVA Network free software directly from dB Technologies ([www.dbtechnologies.com](http://www.dbtechnologies.com)) in the special section «Software & Controller»

### DVA USB Manager

The firmware of the amplifier module can be updated via the USB port.

To make this update possible and simple, a dedicated program has been developed.



It is recommended to download DVA USB Manager free software directly from dB Technologies ([www.dbtechnologies.com](http://www.dbtechnologies.com)) in the special section «Software & Controller»

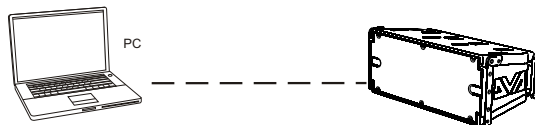

### DVA Composer Acoustical Simulation and aiming for DVA Systems

DVA Composer is a 2D software for aiming and simulating acoustical response of all line arrays and Subwoofers from DVA Series.

The software allows you to set up a stereo system composed by tops and subs, and simulates separately the acoustical response of both

DVA Composer also gives to the user all the information about phase alignment between flown systems and ground stacked subwoofers, as well as it suggests an optimized aiming of the line arrays modules and their suggested EQ presets, in order to guarantee maximum performances even for non-expert customers.



It is recommended to download DVA\_Composer free software directly from dB Technologies ([www.dbtechnologies.com](http://www.dbtechnologies.com)) in the special section «Software & Controller»

## CONTROLS AND FUNCTIONS

### "Balanced Audio" section

- 1) **"INPUT" INPUT CONNECTOR**  
Balanced input at line level. It is able to accept "XLR" sockets.
- 2) **"LINK" OUTPUT CONNECTOR**  
The "XLR" connector connected in parallel with input (1) can be used to send the input audio signal to another amplified speaker.

### "Status" section

- 3) **"LIMITER" INDICATOR LIGHT**  
This indicator comes on red to indicate that the internal limiter circuit has tripped. This prevents amplifier distortion and protects the speakers against overloads.  
 Always avoid operating conditions where the system works for long periods of time with LED flashes or it is always ON
- 4) **"SIGNAL" INDICATOR LIGHT**  
This indicator comes on green to indicate the presence of an input signal to a level higher than -20dBu.
- 5) **"MUTE/PROT" INDICATOR LIGHT**  
This yellow indicator indicates amplifier status. In normal operating conditions, the LED is off; if it flashes or is always on, refer to the diagnostics table to check amplifier status.
- 6) **"READY" INDICATOR LIGHT**  
This indicator comes on green to indicate that the main power voltage is correct. In normal operating conditions, the LED is on; if it flashes or is off, refer to the diagnostics table to check amplifier status.

### "Input control" section

- 7) **"INPUT SENS" INPUT SENSITIVITY CONTROL**  
This control regulates the sensitivity of the signal amplifier input.  
This control does not affect the "BALANCED LINK/OUT" output level

### "RDNET" section

- 8) **INPUT CONNECTOR "DATA INPUT"**  
RJ45 connector 'data input.
- 9) **OUTPUT CONNECTOR "DATA INPUT"**  
RJ45 connector 'data output for cascading connections.
- 10) **"LINK" INDICATION LIGHT**  
This green indicator turns on only when the amplifier has recognized and is connected with the main RDNET unit via the computer.
- 11) **"ACTIVE" INDICATOR LIGHT**  
This yellow indicator flashes when there is an active data transmission between RDNET and the amplifier module.

**"DSP configuration" section****12) "Remote Preset Active" INDICATION LIGHT**

This yellow indicator indicates the exclusion of the Volume control and the "DSP Preset" rotary switch (13) when the amplifier is remotely controlled by a computer via RDNET.

The indicator flashes slowly if the rotary switch is set to 9 and a previously saved user equalization has been stored.

**13) "DSP Preset" 10-position ROTARY SWITCH**

This 10-position rotary switch makes it possible to select the nine preset equalization curves (selector 0-8) or to select the equalization previously saved by the user via RDNET (selector 9).

If this option is not used, curve 9 will be equal to curve 0

Refer to the table for the correspondence of the equalization curve.

**14) "Service Data USB" Connector**

Via this USB connector, it is possible to update the firmware of the DVA T8 amplifier module using the computer and a dedicated program.

**15) "MAINS INPUT" POWER SOCKET**

For connecting the power cable.

The connector used for mains connection is a POWER CON® (blue)

**16) "MAINS OUTPUT LINK" RELAUNCH POWER SOCKET**

For relaunching the mains power. The output is connected in parallel with input (15) and can be used to power another amplified speaker.

The connector uses a POWER CON® (grey)

**17) "MAINS FUSE" FUSE CARRIER**

Mains fuse housing.

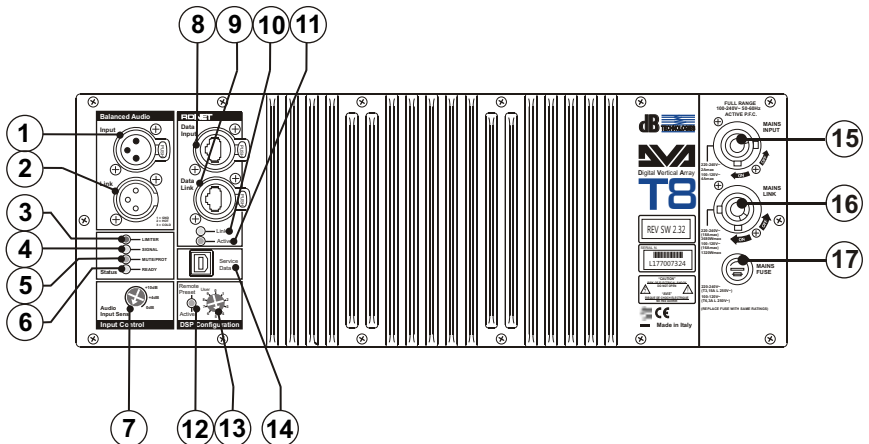

## CHARACTERISTICS AND PROTECTION

### Front Grille

The speakers's components in the box are protected by 1.2mm metal steel grille covered by foam on backside.

### Cooling

Thermal control is managed by the main microprocessor that interacts with the local microprocessors (amplifiers and power supply) and communicates the data to the DSP for any corrections.

If the amplifier module heats up excessively, the volume is gradually reduced step wise to 0.1dB until the module is thermally stabilised.

The volume is automatically restored when the normal operating temperature is reached.

### Power on

The diffusor is powered up normally by an initialization process during which the module is powered by the auxiliary power supply.

When all of the amplifier peripherals are correctly detected, the main power supply is activated.

The IPOS technology (Intelligent Power-On Sequence) introduces a random and differentiated delay for each module prior to the power on of the main PSU (Power Supply Unit).

This prevents the breakaway starting currents of the various modules from accumulating, overloading the AC power supply line.

At the end of the power on procedure, only the green "READY" LED will remain on fixed on the amplifier module.

### Failure indications and safeties

The microprocessor is able to signal three different kinds of failure by flashing the "READY", "MUTE/PROT" and "LIMIT" LED as reported in the table of diagnostic.

The three types of failure are:

- 1) **WARNING:** a non severe error or auto-ripristinate malfunction is detected and the performance of the speaker is not limited
- 2) **LIMITATION:** an error is detected and diffuser performance is limited. The sound level is reduced or one or more amplifiers are disabled.  
This state partially influences the correct functioning of the diffuser.  
If the problem persists the next time the module is turned on, contact the support centre for assistance.
- 3) **FAILURE:** a severe malfunction is detected. The speaker switches to "mute".

If the case of a malfunction, before contacting the support centre, try to turn the module off and on to check if the problem still exists.

### Connecting to the mains supply

Each active speaker features its own power cable. Connection is done by a Neutrik POWER CON® (blue) model which permits easy and fast connection to the speaker as well as being an excellent locking system.

The same connector serves as a switch to turn ON and OFF the active loudspeaker by turning the connector to the left (OFF) or right (ON).

The active speaker must be connected to a power supply able to deliver the maximum required power.

### Main power supply linking

On the rear of the speaker, a Neutrik POWER CON® connector (grey) offers linking the mains power supply.

This socket links the power supply to another speaker, thereby reducing the direct connections to the mains. Maximum amplifier input power is shown on the amplifier panel.

The maximum number of speakers connected together varies of max input power and of the maximum allowed current of the first power socket.

**DIAGNOSTICS TABLE**

MODULE STATUS	LED «READY»	LED «MUTE/PROT»	LED «SIGNAL»	LED «LIMIT»	MODULE FUNCTIONS
Power ON	OFF	ON for 5 sec.	OFF	OFF	Audio MUTED Initialization of the amplifier module
Normal use	ON	OFF	Normal operation	Normal operation	Audio ACTIVE Module initialization complete and correct
Partial fault	ON	Cyclic flashing (3 or more quick flashes)	Normal operation	Normal operation	Audio ACTIVE The module has detected a partial anomaly and remains active with limited functions
Total fault	OFF	ON	OFF	Cyclic flashing	Audio MUTED The module has detected a serious anomaly and is in protected mode
<b>Amplifier temperature management:</b>					
First thermal threshold	ON	Cyclic flashing (1 slow flashes)	Normal operation	Normal operation	Audio ACTIVE The amplifier module begins a gradual decrease of the volume in 0.1dBm steps to compensate temperature increase up to a maximum reduction of 3dBm.
Second thermal threshold	ON	Cyclic flashing (2 quick flashes)	Normal operation	Normal operation	Audio ACTIVE The amplifier module reduces the volume further 3dBm always in 0.1dBm steps up to a maximum reduction of 6dBm respect original volume.

NB The temperatures shown on the plug-in RDnet software refer to the internal temperature of the power semiconductors. These temperatures are not displayed the temperatures of accessible parts user

**MODULE STATUS**

RDNET not active	LED «Remote Preset Active»	LED «LINK»	LED «ACTIVE»	MODULE FUNCTIONS
	OFF	OFF	OFF	The module is functioning normally. The volume (INPUT SENS) and the rotary switch (DSP Preset) are active
RDNET connect	ON	ON	Cyclic flashing	The amplifier module is remotely controlled by RDNET. The volume (INPUT SENS) and the rotary switch (DSP Preset) are bypassed
Equalization «USER Eq» (rotary switch «DSP Preset» set to 9)	Cyclic flashing	OFF	OFF	The module functions normally. The equalization saved by means of RDNET is being used.

**TECHNICAL SPECIFICATION**

System	Active 3-Amps
Type of amplifier	Digital - Class D DIGIPRO G2 technology
RMS power	700W
High (HF) RMS	175W
Mide (MF) RMS	175W
Low (LF) RMS	300W
Musical power	1400W
Frequency response (-6dB)	66-18.000Hz
Frequency response (-10dB)	61-19.900Hz
Crossover MF-HF (Mid-High)	1900Hz 24dB/Oct
Crossover LF-MF (Low-Mid)	400Hz 24dB/Oct
Sound pressure (SPL)	132dB max
Component parts	1 woofer 8" - VC 2.5" - Neodymium 1 midrange 6,5" - VC 2" - Neodymium 2 compression driver 1" - VC 1.4" - Neodymium
Input sensitivity nominal	0dBu
Input impedance	
Balanced	20Kohm
Unbalanced	10Kohm
Power supply	Full-range with PFC and SMPS 100-240V~ 50-60Hz
Inrush current	3,3A
Dimension (WxHxD)	580x386x327mm (23,2x9,6x13,08 inch.)
Weight	14,2Kg (31,3 lbs)

**DSP PROCESSOR**

DSP	Analog Device <sup>®</sup> 56 bits
Audio conversion	24 bit / 96kHz S/N=114dB
Volume control	Digital
Equalization	9 preset EQU

**MECHANICAL PARTS**

Box material	Polipropilene (PP)
Box internal reinforcement	Steel
Flying support material	Steel
Stirrup angle	0° - 1,5° - 3° - 4,5° - 6° - 8° - 10° - 12,5° - 15°
Housing shape	Trapezoidal - angle 15°
Handle	1 x side
Rear grille	Performed sheet 1.2mm with internal foam

**EMI CLASSIFICATION**

According to the standards EN 55103 this equipment is designed and suitable to operate in E3 (or lower E2, E1) Electromagnetic environments.



## INSTALLATION



### WARNING

Make sure that the loudspeaker is securely installed in a stable position to avoid any injuries or damages to persons or property.

Before hanging the loudspeaker check all the components for damages, deformations, missing or damaged parts that may compromise safety during installation.



### ATTENTION

The installation of the speaker on speaker stand must be carried out exclusively by professionally qualified staff, being careful to place a speaker stand foot in the direction of the output side of the sound (front side of the speaker) so as to maximize stability in relation to the centre of gravity of the speaker (ref. page 58).



### ATTENTION

When using the speaker with a pole mount for subwoofer (ref. page 59), in order to avoid the danger of overturning and damage to people, animals and properties, before proceeding with the installation of the system, check the allowed configurations, the indications and the related requirements on the site of dBTechnologies. However, make sure that the subwoofer which supports the speaker is placed on a horizontal surface without inclinations.



### CAUTION

TO REDUCE THE RISK OF ELECTRICAL SHOCK, GROUNDING OF THE CENTER PIN OF THIS PLUG (POWERCON AC MAINS CONNECTOR) MUST BE MAINTAINED

## DRK 10

DVA system has obtained the TÜV certification for suspension of DVA T4, DVA T8, DVA T12, DVA S09dp, DVA S10dp, DVA S1518N and DVA S2585N speakers through flybar stirrup DRK 10 for maximum weight applying is 250Kg.



**WARNING! Observe with particular attention the maximum load allowed.**

**Failure to comply with all warnings may cause danger of structure and content falling with potential damage to people, things and animals.**

### DVA T8 configuration

The DRK 10 flybar attests that the maximum number of DVA T8 is 16.

Refer to table 1 to determine the total weight borne by flybar according to the different DVA T8 configurations.

Quantità	Peso	
	[kg]	[lbs.]
1	15	33
2	30	66
3	45	99
4	60	132
5	75	165
6	90	198
7	105	231
8	120	264
9	135	297
10	150	330
11	165	363
12	180	396
13	195	429
14	210	462
15	225	495
16	240	528

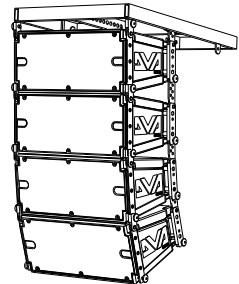

Table 1

### DVA S10dp configuration

The DRK 10 flybar attests that the maximum number of DVA S10dp with Neodymium woofer is 4 and DVAS10dp with Ceramic woofer is 5.

Refer to table 2 to determine the total weight borne by flybar according to the different configurations.

Quantity DVA S10dp (Neodymium woofer)	Weight		Quantità DVA S10dp (Ceramic woofer)	Weight	
	[kg]	[lbs]		[kg]	[lbs]
1	48	106	1	54	119
2	96	212	2	108	238
3	144	317	3	162	357
4	192	423	4	216	476
5	240	528			

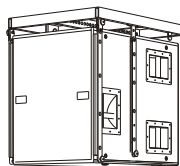

Table 2

### DVA S1518N configuration (Neodymium woofer)

The DRK 10 flybar attests that the maximum number of DVA S1518N is 5.

Refer to table 3 to determine the total weight borne by flybar according to the different configurations.

Quantity (Neodymium woofer)	Weight	
	[kg]	[lbs.]
1	46	102
2	92	203
3	138	304
4	184	405
5	230	506

Table 3

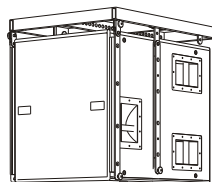

### Mixed configuration

The modular structure of DVA system permits mixed suspension configuration between speakers.

For this reason it is necessary to calculate the total weight according to the different configurations.

Examples:

	Quantity	Weight x qty	Configuration weight
DVA T8	8	120Kg	<b>216Kg</b>
DVA S10dp (Neodymium woofer)	2	96Kg	

	Quantity	Weight x qty	Configuration weight
DVA T8	12	180Kg	<b>226Kg</b>
DVA S1518N (Neodymium woofer)	1	46Kg	

### **DRK 20**

The DRK 20 flybar system and its rigging systems used for DVA T4, DVA T8, DVA T12, DVA S09dp, DVA S10dp, DVA S1518N e DVA S2585N speakers is designed and verified by tests in accordance with safety requirements documents, Italian Ministerial Decree DM of 14.01.2008 "New technical standards for construction" and "Eurocode 1" and Eurocode 3 " with regard to steel structures.

The system are technically tested and certified to comply with the maximum load declared by Certificate of Compliance issued by CERMET n.reg. PA 68913 V 00001 2011.



**The DRK 20 must be used only by qualified persons!**

The structural calculations certify that maximum weight applicable to the flybar DRK20 depends on the attachment point of the lifting hook.

Refer to the dedicated manual for details



**WARNING!** Observe with particular attention the maximum load of point of attachment of the lifting hook.

Failure to comply with all warnings may cause danger of structure and content falling with potential damage to people, things and animals.

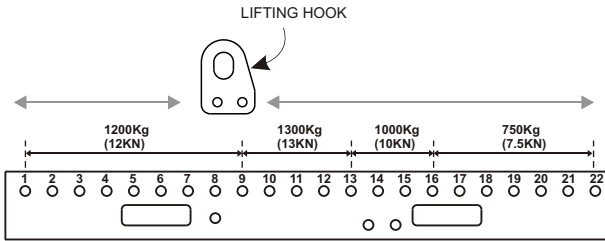

Lifting hook position	Maximum load
1 - 9	1200kg
9 - 13	1300kg
13 - 16	1000kg
16 - 22	750kg

### **Mixed configuration with DVA T8 and DVA T12**

The modular structure of DVA System permits mixed suspension configuration between DVA T8 and DVA T12.

For this reason, it is necessary to calculate the total weight.

Example:

	Quantity	Weight x qty	Configuration weight
DVA T12	10	300Kg	<b>390Kg</b>
DVA T8	6	90Kg	

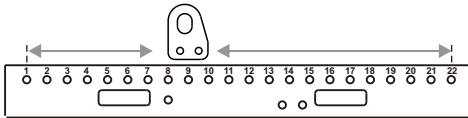

### **Mixed configuration with DVA T8 and DVA S10dp (Neodymium woofer)**

The modular structure of DVA System permits mixed suspension configuration between DVA T8 and DVA S10dp (Neodymium woofer).

For this reason, it is necessary to calculate the total weight.

Example:

	Quantity	Weight x qty	Configuration weight
DVA T8	14	210Kg	<b>402Kg</b>
DVA S10dp (Neodymium woofer)	4	192Kg	

### **Mixed configuration with DVA T8 and DVA S1518N (Neodymium woofer)**

The modular structure of DVA System permits mixed suspension configuration between DVA T8 and DVA S1518N (Neodymium woofer).

For this reason, it is necessary to calculate the total weight.

Example:

	Quantity	Weight x qty	Configuration weight
DVA T8	20	300Kg	<b>484Kg</b>
DVA S1518N (Neodymium woofer)	4	184Kg	

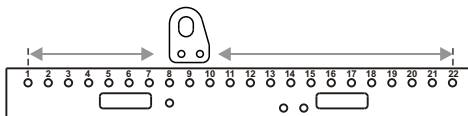

### Structural modification of flybar

It is prohibited to make any changes to the structure of the flybar and on the stirrups assembling of the speakers.

Tampering and/or modify the structure or the accessories may be causes risk of failure or breakage.

### Original parts dB Technologies

It is forbidden to use parts and accessories other than those supplied.

Use only dB Technologies original parts.

Always install parts in accordance with these installation instruction!

Compile and store all DVA system documents in a safe place!



#### Warning

dB Technologies is not responsible for any possible damage to people, things and animals if the security norms and total weight calculations are not observed!

### Note

During installation ensure that carrying structure of the system has added in the total weight also the flybar weight, chain hoists, motors, cables and further weights.

### Initiation and Operation

§ 39, VBG 9a of the German employers' liability insurance association's accident prevention regulations requires that load-carrying equipment be inspected by a qualified expert and possible defects be eliminated prior to initial commissioning by the recipient.

§ 41 VBG 9a requires that load-carrying equipment be subjected to a non-routine inspection following damage, repair work and other incidents that can affect load-carrying capacity.





#### Warning

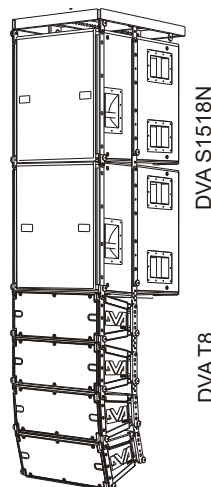
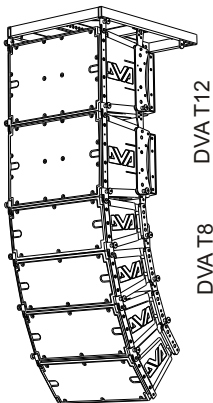





The safety regulations might be different in other countries. Please check with your national safety authority the valid regulations!



## DVA T8 QUICK CONFIGURATIONS

SINGLE MODULE FREQUENCY RESPONSE	EQUs SET
	FLAT <b>0</b>
	HF BOOST <b>1</b>

### FLYBAR at 0°

NUMBER OF MODULES	SHAPE	ANGLES	EQUs SET
<b>FROM 4 TO 6</b>	 *	STRAIGHT from 0° to 4,5°	<b>2</b>
		CURVED from 6° to 15°	<b>3</b>
<b>FROM 7 TO 10</b>	 *	STRAIGHT from 0° to 4,5°	<b>4</b>
		CURVED from 6° to 15°	<b>5</b>
<b>MORE THAN 10</b>	 *	STRAIGHT from 0° to 3°	<b>6</b>
		MID CURVED from 4,5° to 6°	<b>7</b>
		CURVED from 8° to 15°	<b>8</b>

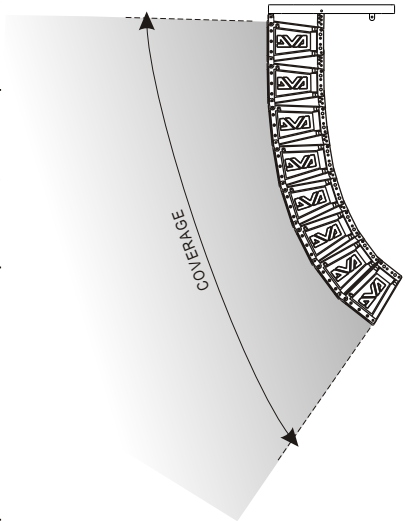

\* APPLY "STRAIGHT" SHAPE EQ ON THIS BOX

## SET-UP EXAMPLES

CONFIGURATION : FRONT FIELD  
N° OF BOX: 2

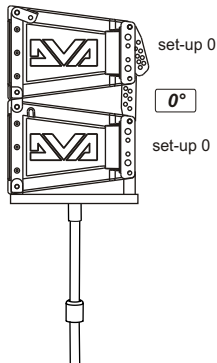

CONFIGURATION : FRONT FIELD  
N° OF BOX: 2

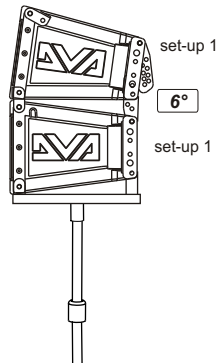

## SET-UP EXAMPLES

CONFIGURATION : LINE ARRAY  
N°OF BOX: 4

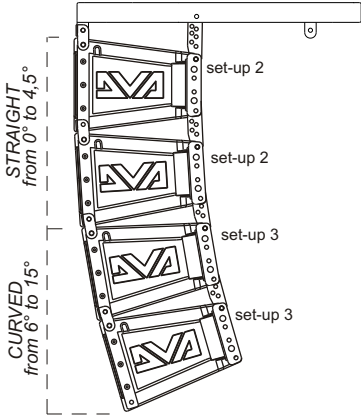

CONFIGURATION : LINE ARRAY  
N°OF BOX: 11

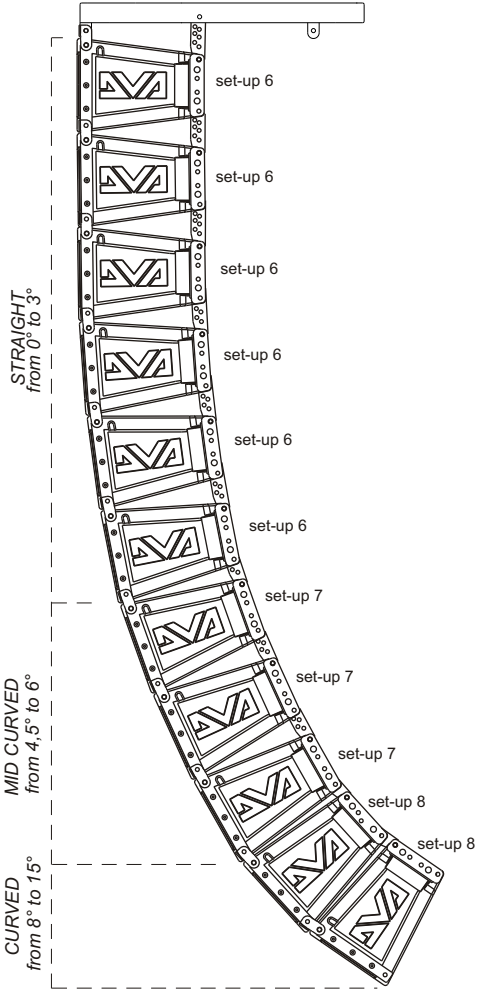

CONFIGURATION : LINE ARRAY  
N°OF BOX: 8

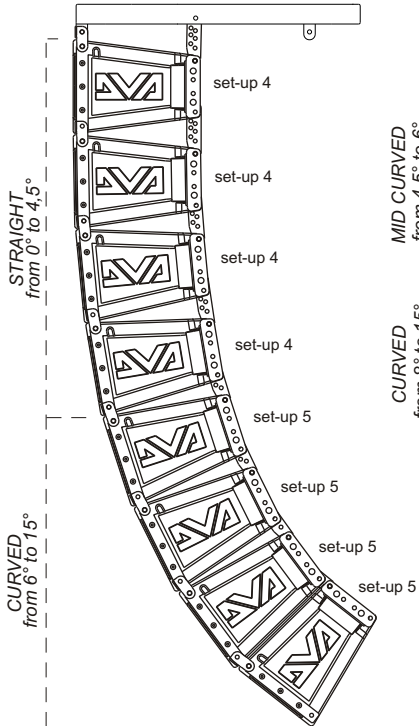

DIMENSIONI  
DIMENSIONS  
ABMESSUNGEN  
DIMENSIONS

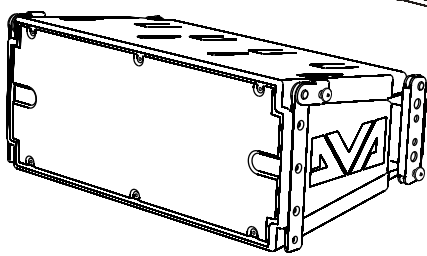
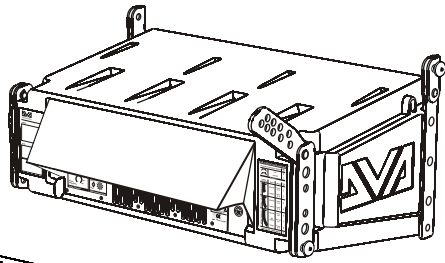
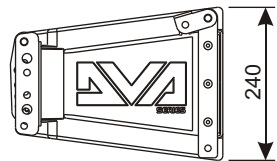
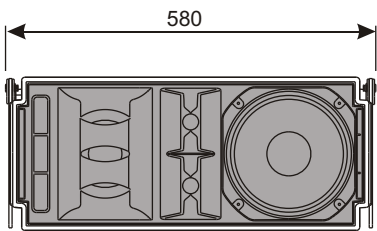
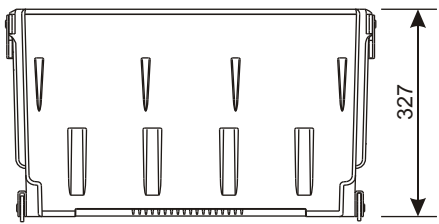
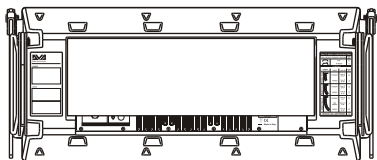

**SCHEMA A BLOCCHI  
BLOCK DIAGRAM  
BLOCKSCHALTBIKD  
SCHEMAS FONCTIONNELLS**

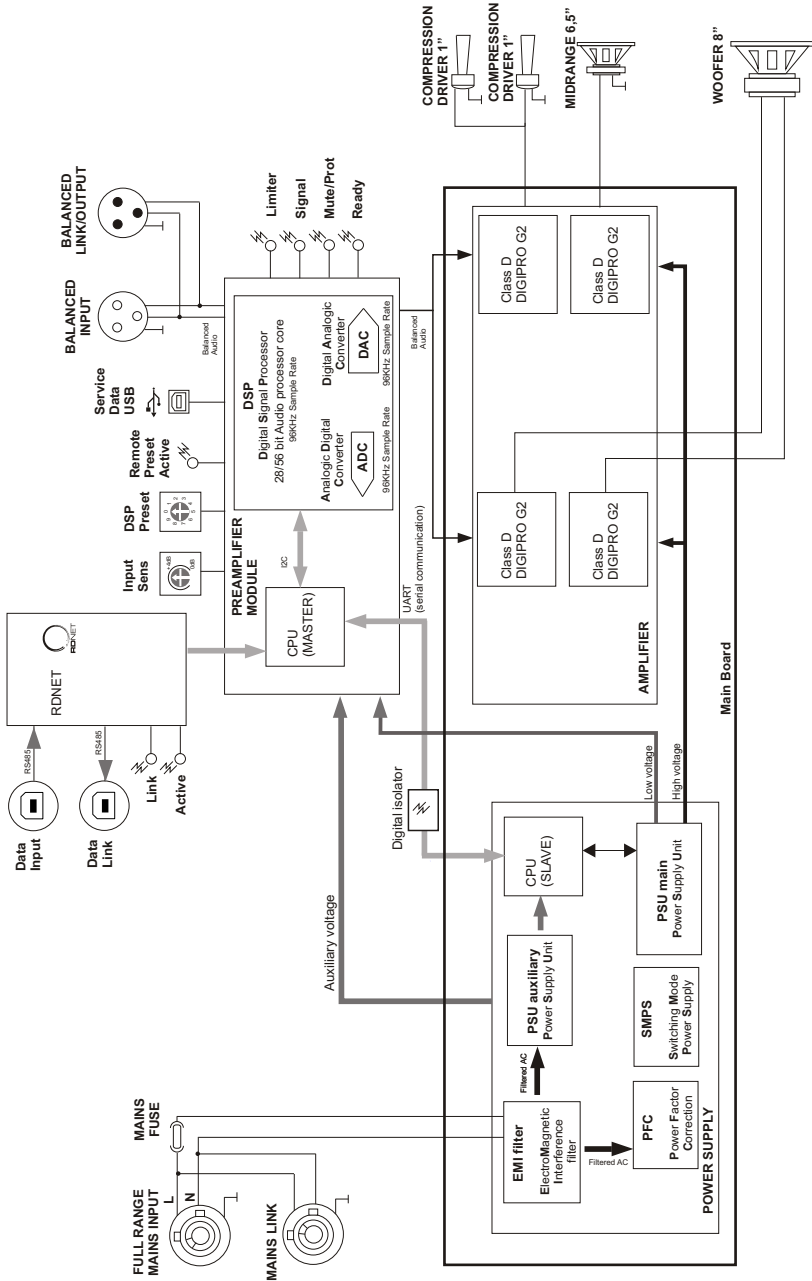



**DRK 10 accessorio  
Accessory DRK 10**

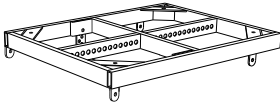

Appeso  
Hanging on

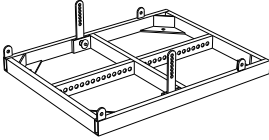
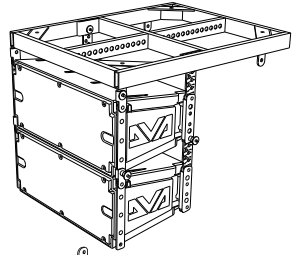

In appoggio  
Groundstack

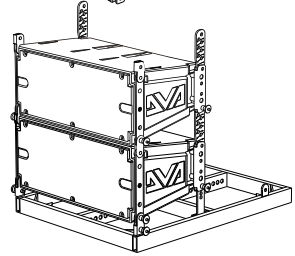

Appeso  
Hanging on

**INSTALLAZIONE  
INSTALLATIONEN**      **INSTALLATION  
INSTALLATIONS**

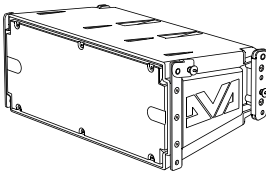

Phase 1

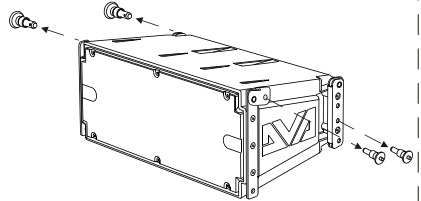

Phase 2

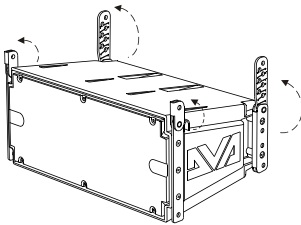

Phase 3

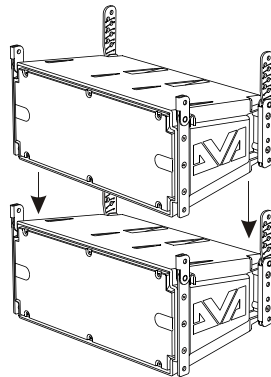

Phase 4

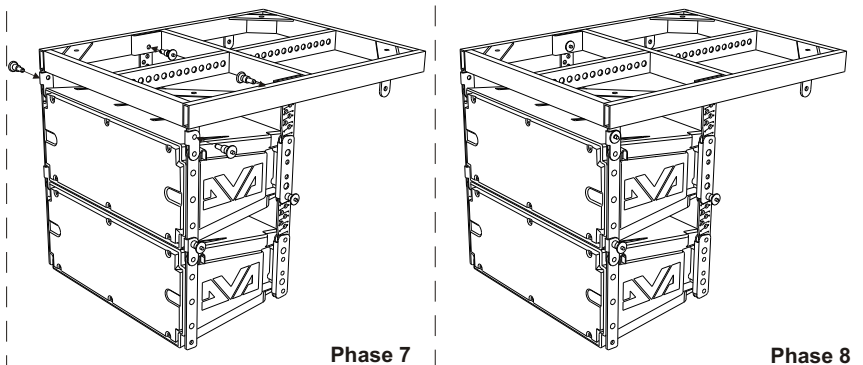
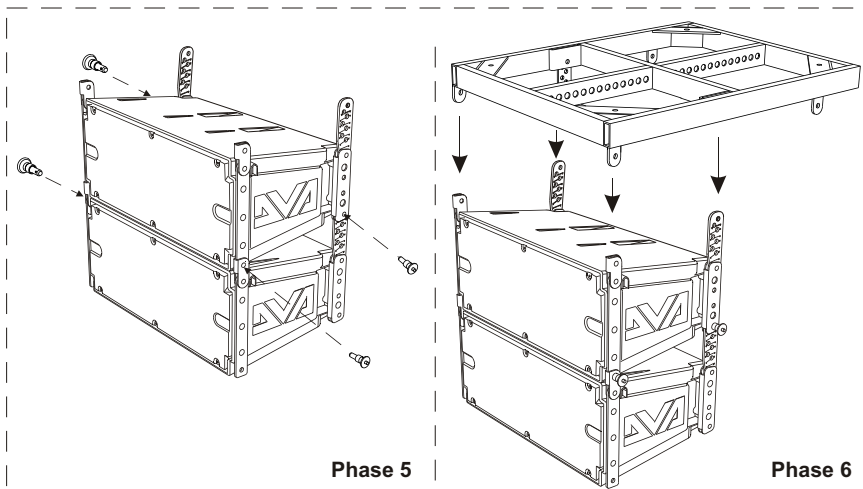

**INCLINAZIONE INCLINATION  
NEIGUNG INCLINAISON**

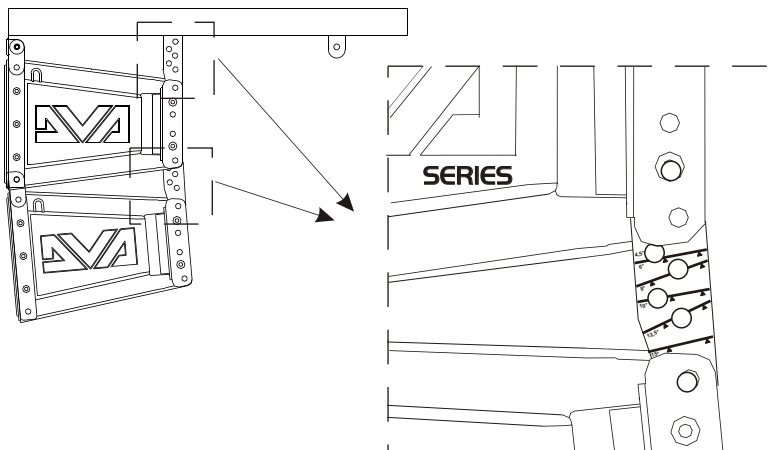

In appoggio  
Groundstack

INSTALLAZIONE  
INSTALLATIONEN

INSTALLATION  
INSTALLATIONS

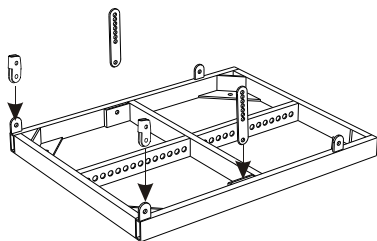

Phase 1

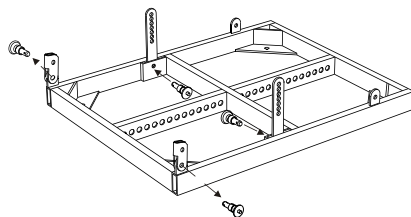

Phase 2

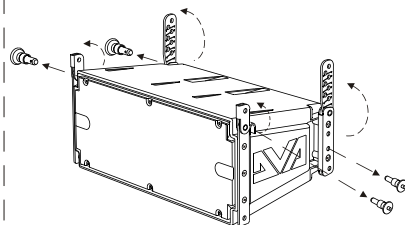

Phase 3

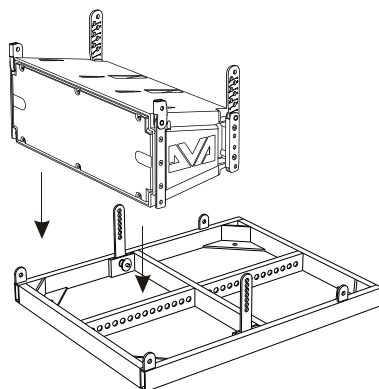

Phase 4

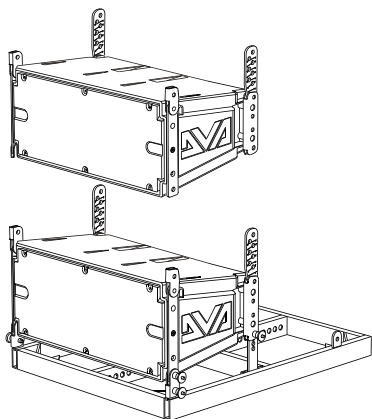

Phase 5

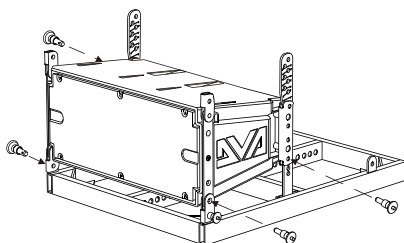

Phase 6

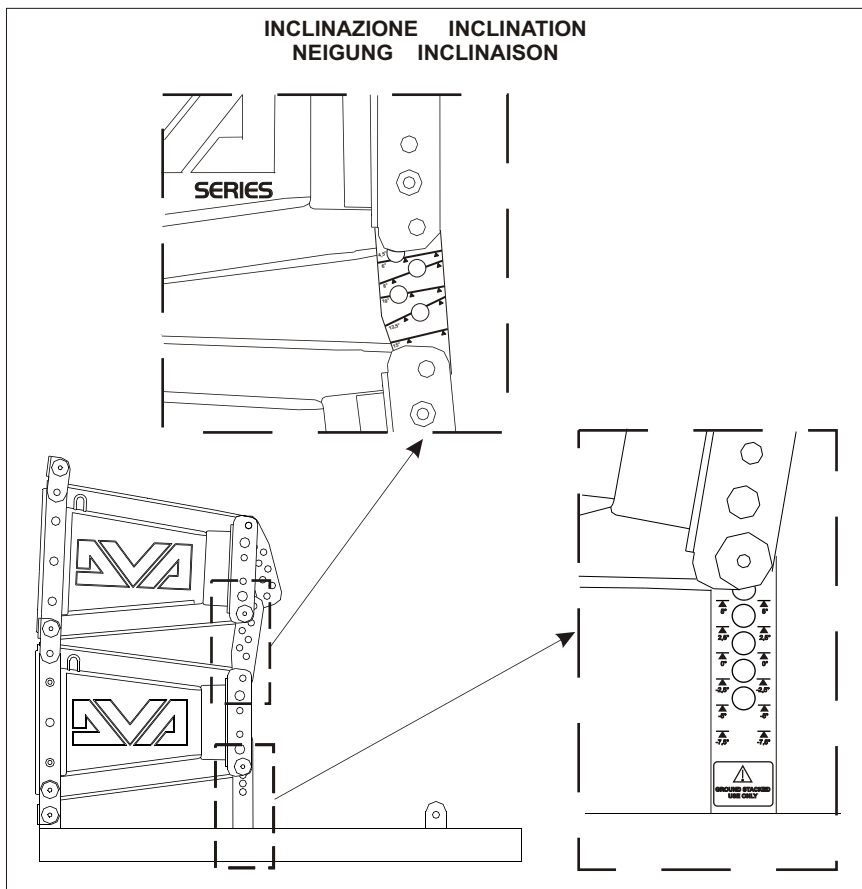
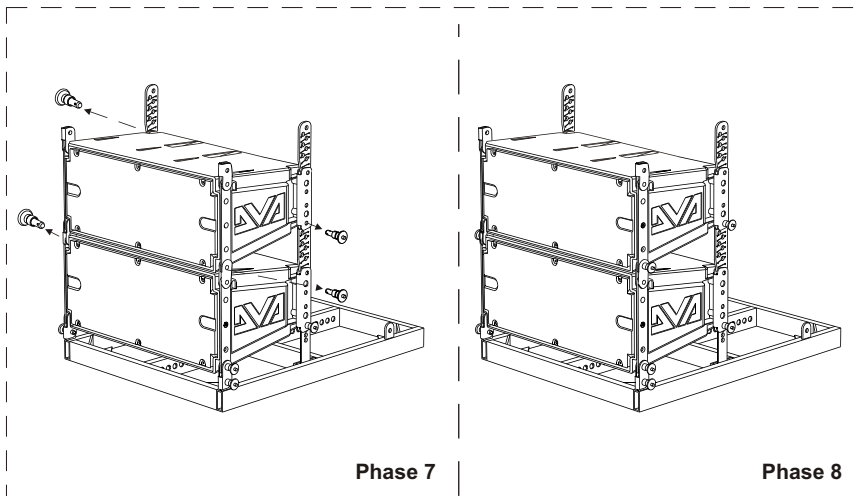

**DRK 20 accessorio  
Accessory DRK 20**

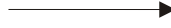
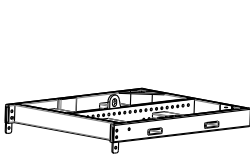

Appeso  
Hanging on

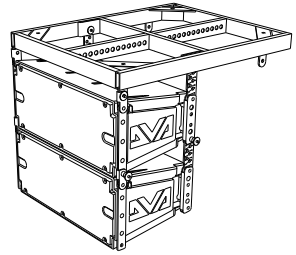

Appeso  
Hanging on

**INSTALLAZIONE  
INSTALLATIONEN**      **INSTALLATION  
INSTALLATIONS**

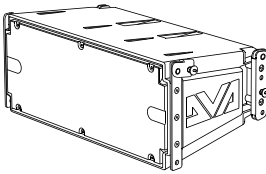

Phase 1

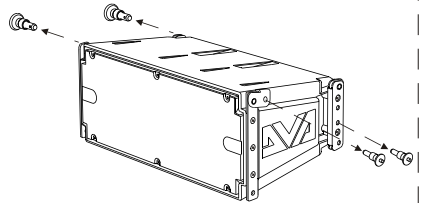

Phase 2

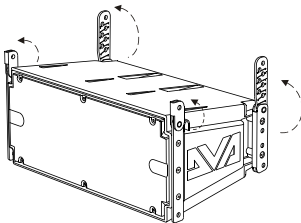

Phase 3

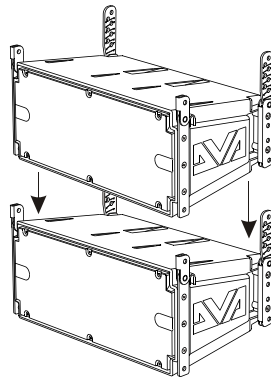

Phase 4

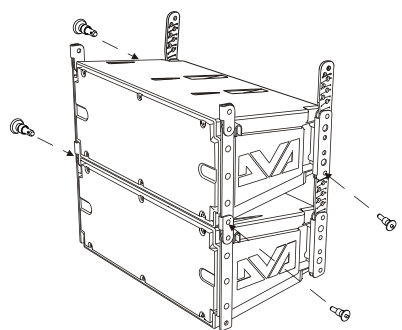

Phase 5

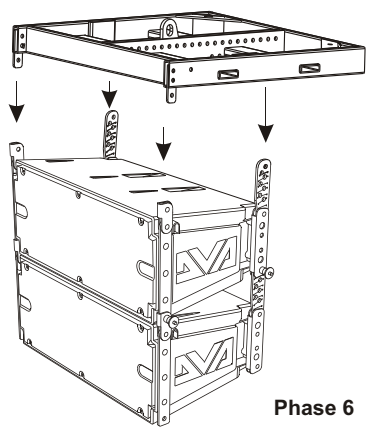

Phase 6

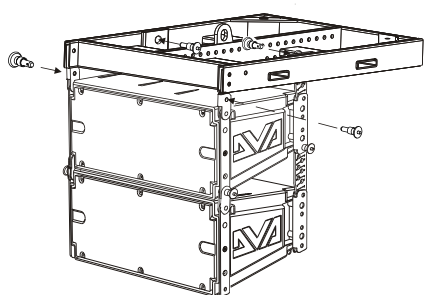

Phase 7

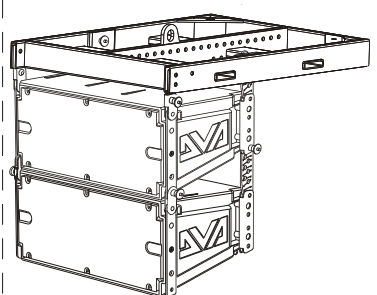

Phase 8

**INCLINAZIONE INCLINATION  
NEIGUNG INCLINAISON**

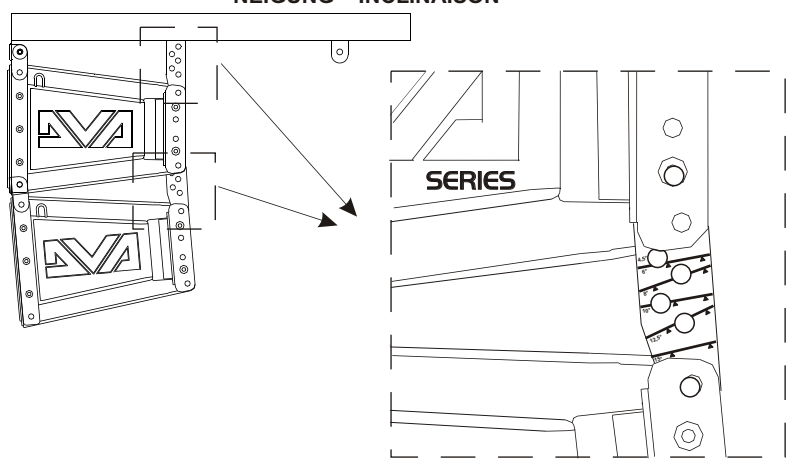

## DVA T8 + DVA S1518N

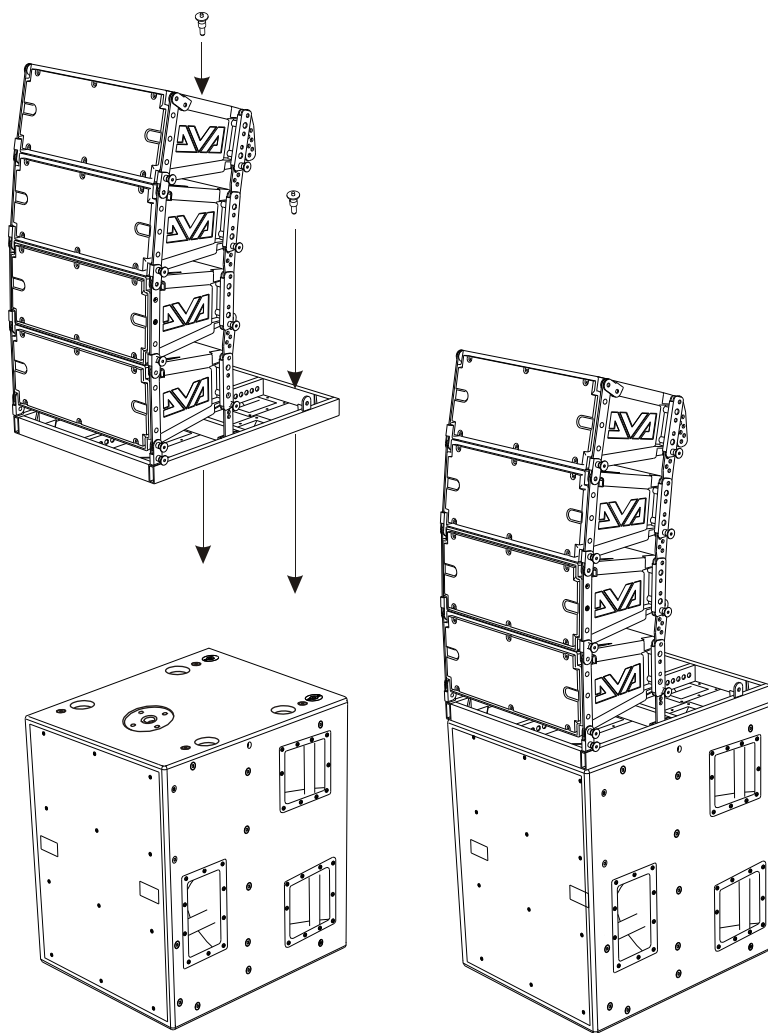

Utilizzo in appoggio verticale (DVA T8 montaggio "Ground stacking")  
Supported use (DVA T8 "Ground stacking" assembling)

## DVA T8 + DVA S30N

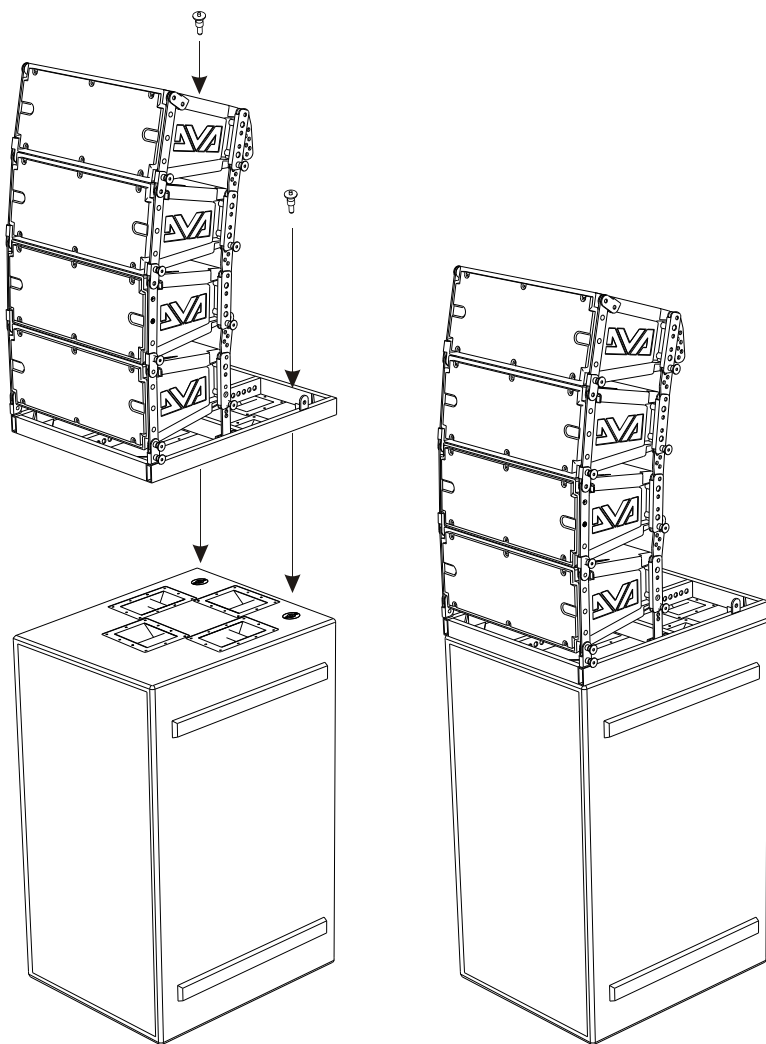

Utilizzo in appoggio verticale (DVA T8 montaggio "Ground stacking")  
Supported use (DVA T8 "Ground stacking" assembling)



**Opzione DSA 4  
DSA 4 Option**

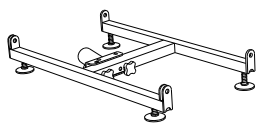

→  
In appoggio  
Floor stack

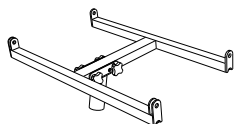
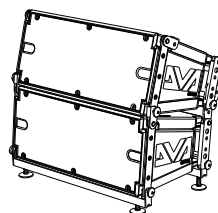

→  
Per supporto asta  
Stand adaptor

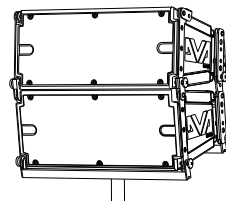

In appoggio  
Floor stack

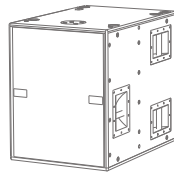
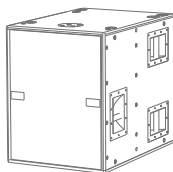
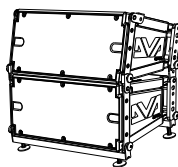
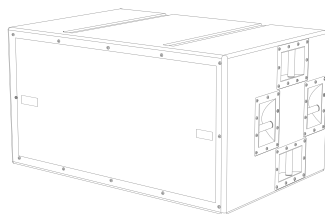
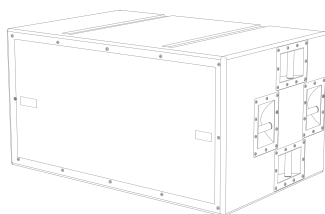
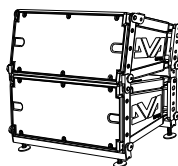

Per supporto asta  
Stand adaptor

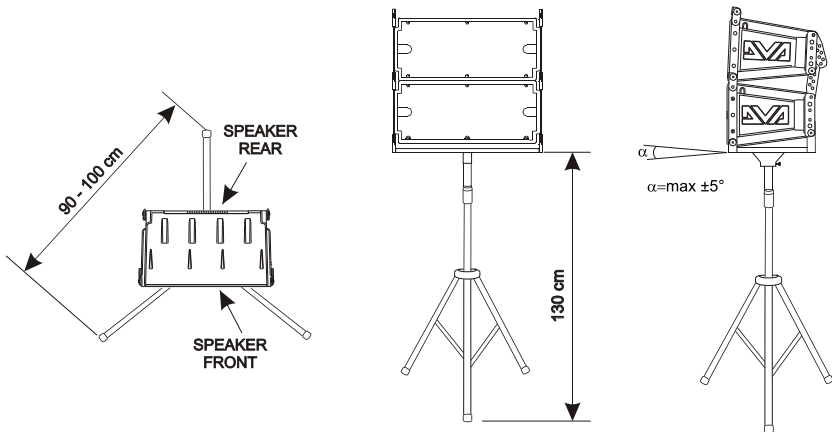
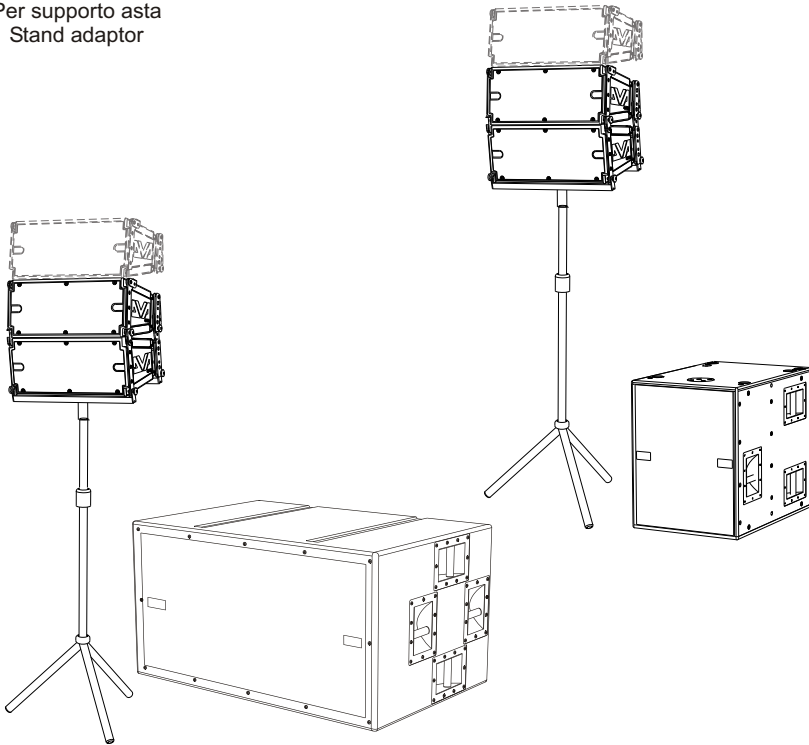

Per supporto asta  
Stand adaptor

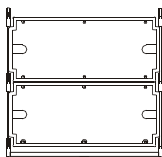
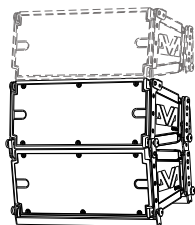

87 cm

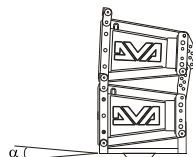

$\alpha = \max \pm 5^\circ$

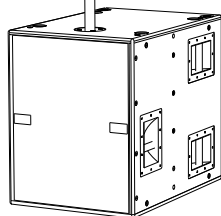

Solo con / Only with  
DVA S10dp or DVA S1518N

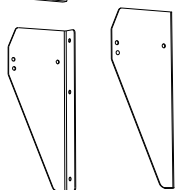
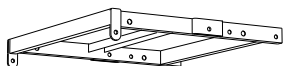

Staffa a muro - opzione DWB 3  
Wall bracket - DWB 3 option

*Gli accessori per il fissaggio della staffa  
non sono forniti in dotazione  
The fixing accessory for wall bracket are  
not supplying with the kit*

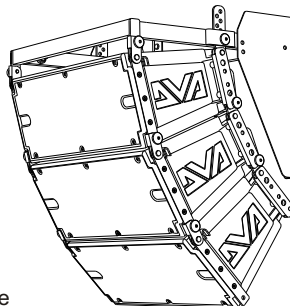
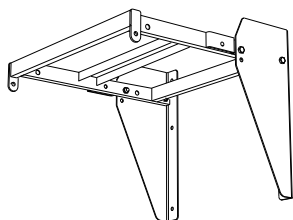

Fissaggio a muro con staffe  
Wall brackets fixing

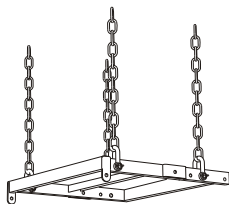

Fissaggio a muro con staffa e catene  
Wall bracket and chains fixing

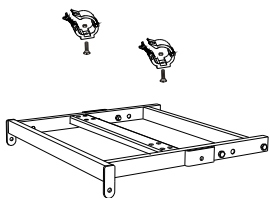
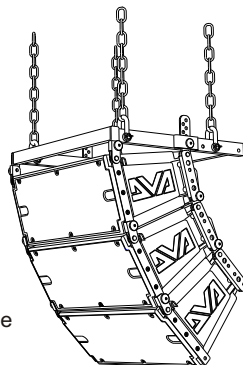

Fissaggio su strutture a traliccio  
Fixing on truss structures

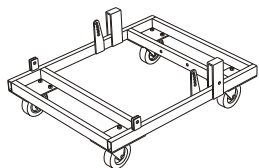
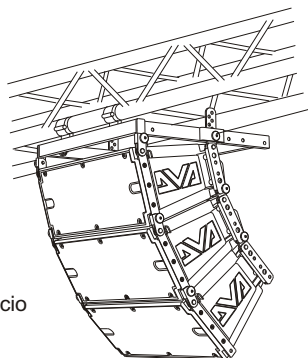

Carello - opzione DT 6  
Trolley - DT 6 option

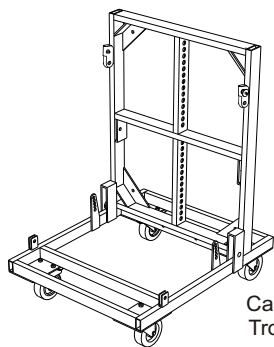

Flybar

Carello  
Trolley

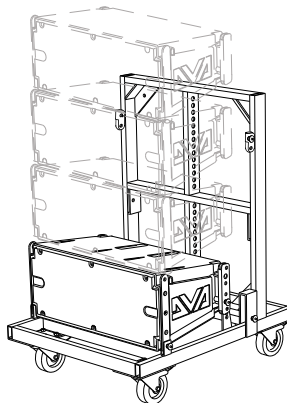

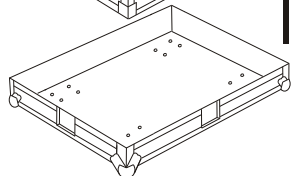
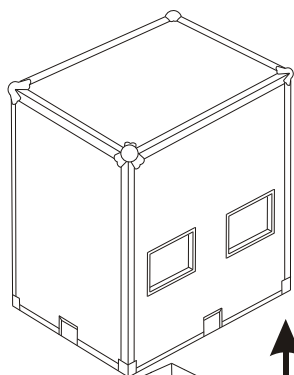
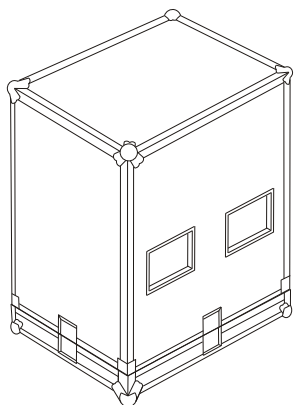

Flightcase per 4 DVA T8 - opzione DF 4  
Flightcase for 4 DVA T8 - DF 4 option

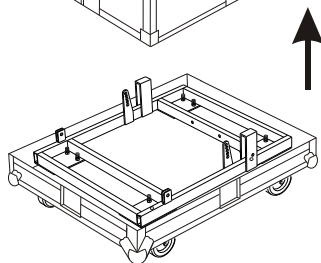
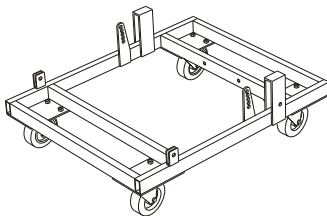
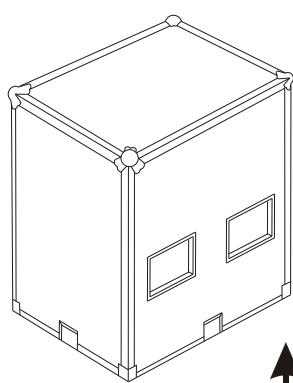
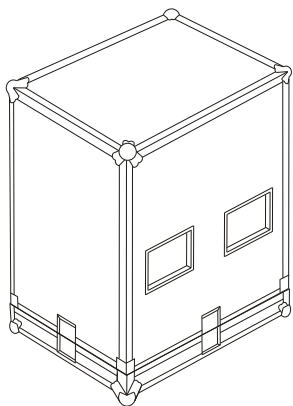

Opzione DTF 4  
DTF 4 Option

DTF 4 = DT 6 + DF 4

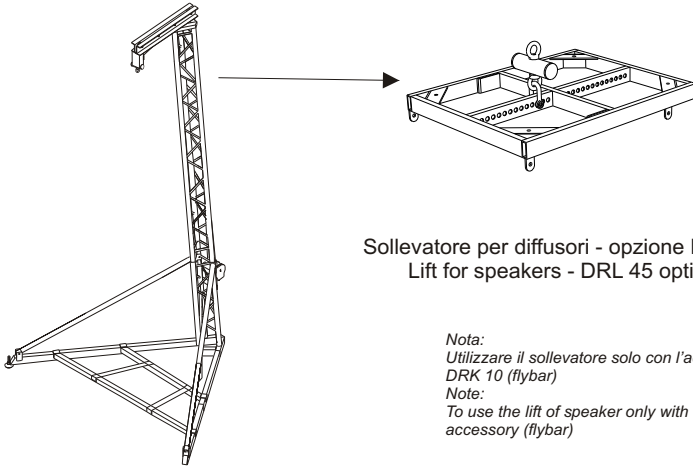

Sollevatore per diffusori - opzione DRL 45  
Lift for speakers - DRL 45 option

*Nota:  
Utilizzare il sollevatore solo con l'accessorio  
DRK 10 (flybar)*  
*Note:  
To use the lift of speaker only with DRK 10  
accessory (flybar)*

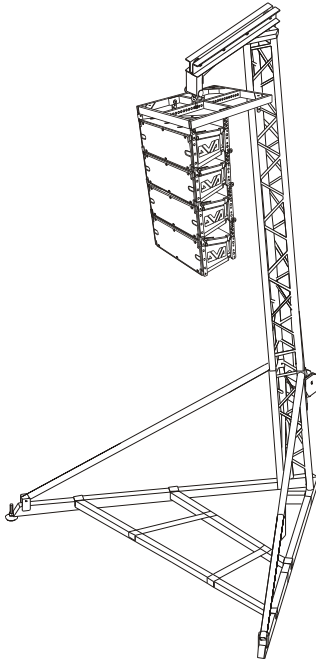

Quando viene utilizzato un carrello, usare cautela durante lo spostamento dell'apparecchio per evitare infortuni a causa di capovolgimenti.

When a cart is used, use caution when moving the cart-apparatus to avoid injury from tip-over.

Beim Verfahren des Geräts auf einem Wagen darauf achten, dass es nicht zu Unfällen kommt, weil das Gerät umkippt.

Quand on utilise un chariot, déplacer l'appareil avec précaution afin d'éviter des accidents à cause de renversements.



**A.E.B. INDUSTRIALE s.r.l.**

Via Brodolini, 8 - 40056 Crespellano (Bo) - ITALIA

Tel. + 39 051 969870 - Fax. + 39 051 969725

Internet: [www.dbtechnologies.com](http://www.dbtechnologies.com)

E-mail: [info@dbtechnologies-aeb.com](mailto:info@dbtechnologies-aeb.com)