



Technical Notes Volume 1, Number 28

Forward Steered Arrays in Precision Directivity™ Speaker Systems

Introduction

Effective high-powered low-frequency systems are a desired feature of many sound reinforcement applications. However the resulting interaction of the many drivers in the resulting system creates problems of sound energy directivity that are either unforeseen, difficult to control, or otherwise not desired.

For instance, the act of stacking a large number of low-frequency elements together creates the undesirable effect of excessive beaming. Although this narrowing may be desirable – especially when controlled by frequency tapering throughout the band – it creates an inherent limitation of the quantity of LF devices that can be effectively added to an array where a wider or more consistent polar response is desired without detrimental lobing. Using Bessel arrays or large curved arrays may also accomplish the purpose. Bessel arrays may not provide the desired polar coverage, are inefficient, and do not provide a great deal of off-axis attenuation.

Curved arrays must be on the order of two wavelengths long or greater to effectively control the polar pattern. Curved arrays also beam when the length of the array becomes less than two wavelengths and do not provide much useful off-axis (rear) attenuation at low frequencies.

Two desirable characteristics of a low-frequency system would be to provide a single “lobe” of energy to the coverage area – that is one where there is no major dips or peaks in the response – and to minimize response in areas that are outside of the coverage area.

A good example of an application that may require a large number of LF drivers to meet high SPL requirements and requiring a wider vertical polar pattern is a cluster in a sports arena. Generally the system requirements are 105 dB at 120 feet with a vertical polar coverage requirement of 90 degrees. High SPL applications that require a narrower vertical pattern are performing arts venues and touring systems. Both systems benefit from a high degree of rejection from the rear of the array.

Modular, extensible low-frequency arrays have been conceived which allow the creation of multi-driver arrays that create high sound pressure levels, maintain a wider pattern if desired, and maximize the off-axis rejection of energy by steering the sound energy forward. These forward-steered arrays have been developed to create a single, main lobe of energy that provides relatively constant SPL levels over a defined coverage angle. The arrays are robust in the fact that they may be configured in a range of sizes, steered, and tapered to create an energy lobe that is most appropriate for its application.

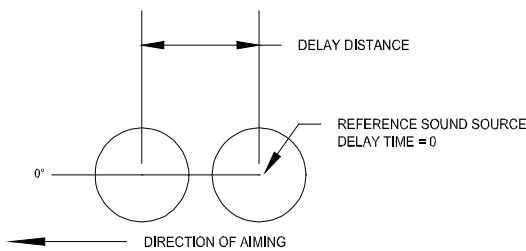

TWO-DRIVER END-FIRED ARRAY

Theory

Forward-steered arrays are based on the end-fired array principle that has been briefly described by Olson¹. The simplest example to consider is where two drivers are spaced on-axis to the direction of aiming. When the front driver's signal is delayed corresponding to the sound propagation time between the drivers, there is coherent summing in the direction of the array. If the spacing of the two drivers is chosen to be one-quarter of a wavelength, then at that frequency there will be a null behind the array. This is the result of the forward element being delayed $\frac{1}{4}$ wavelength added to the physical separation of $\frac{1}{4}$ wavelength. The energy directly behind the array is then offset $\frac{1}{2}$ wavelength creating a null at that single frequency. With a two-element array, this null changes into useful attenuation for about half and octave or so centered on this frequency center.

TWO-SOURCE END-FIRED ARRAY

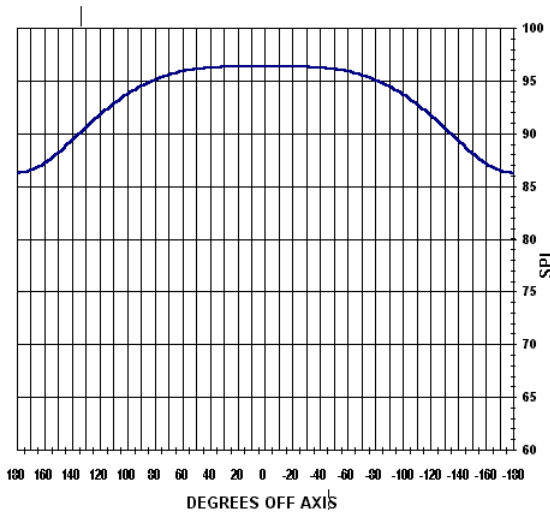

SPACING = $\frac{1}{4} \times 0.8$ WAVELENGTH

TWO-SOURCE END-FIRED ARRAY

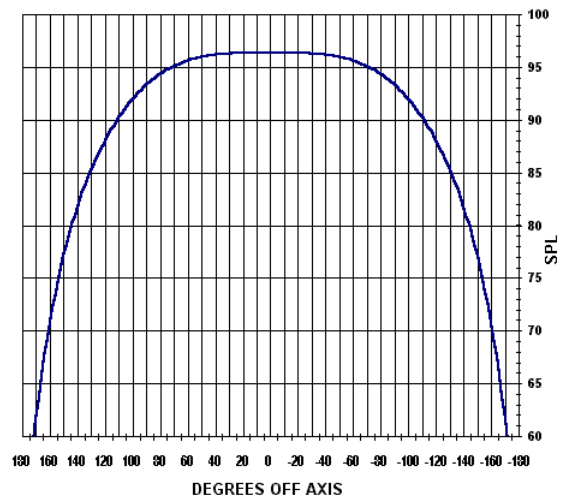

SPACING = $\frac{1}{4}$ WAVELENGTH

TWO-SOURCE END-FIRED ARRAY

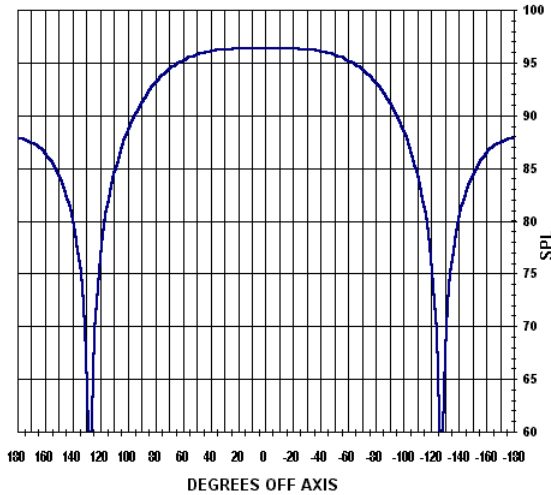

SPACING = $1/4 \times 1.25$ WAVELENGTH

TWO-SOURCE END-FIRED ARRAY

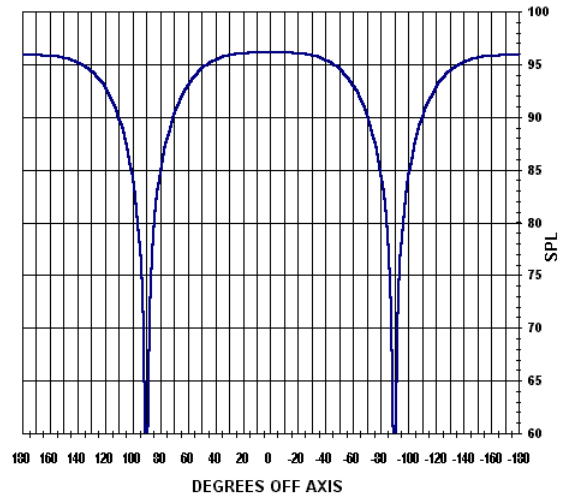

SPACING = $1/2$ WAVELENGTH

When multiple elements are used in an end-fired line-array configuration, the length of the array determines its low-frequency useful limit and the resolution or spacing of the elements determines its useful upper limit – that is, where the side lobes are at least 6 dB lower than the main lobe. At the lower limit, approximately 6 dB of off-axis rejection is provided when the length of the array is approximately one-quarter wavelength. At the upper frequency limit, the side lobes remain 6 dB less than the main lobe when the resolution or spacing of the array elements is less than approximately 0.4 to 0.5 times the wavelength.

Consider a five-element end-fire line-array with a spacing of 1 foot. The overall length of the array is then four feet. At 70 Hz, one-quarter wavelength, the array provides approximately 6dB attenuation, less at lower frequencies. At 450 Hz, where the spacing of the array is 0.4 times the wavelength, the side lobes remain suppressed by at least 6 dB. Intermediate frequencies of 140 Hz and 280 Hz are also shown to help describe the polar characteristics of the array.

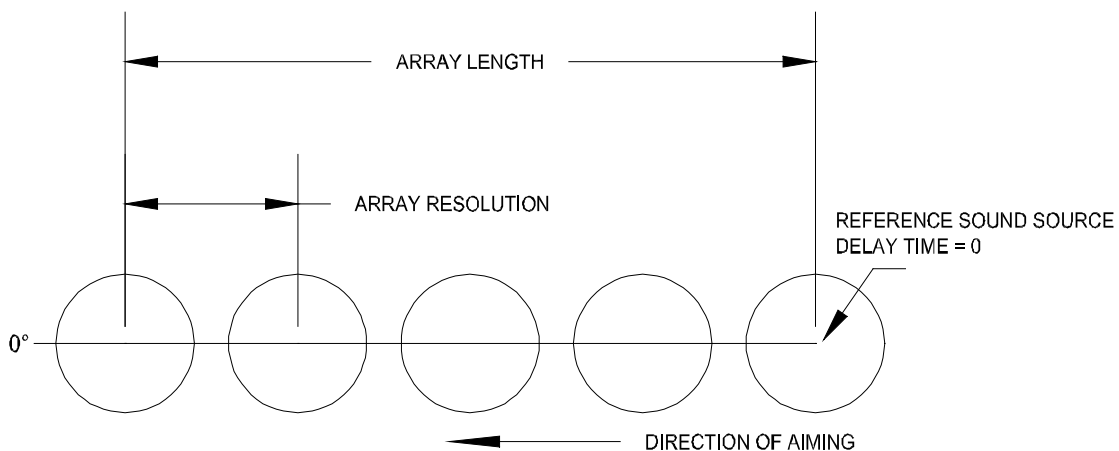

FIVE-DRIVER END-FIRED ARRAY

As described in this example, in the frequencies between its useful limits, a multiple-element end-fire array produces substantial off-axis rejection. Note that the main lobe has a relatively flat response throughout much of its effective coverage area with a relatively steep polar cut-off. Increasing the number of elements will provide greater off-axis rejection, however, the main lobe directivity will also increase.

The nature of this basic end-fired array is that the width of the main lobe changes as the array goes through its useful frequency range as expressed by the off-axis performance. This may

be tolerable in applications where the highest total directivity and power from the array is desirable. By adding additional elements above, and/or below to create a three-dimensional array, arrays can be conceived that narrows the pattern of the array, while coherently adding power. By trading off height, width, depth, and resolution of the array, an unlimited number of array characteristics can theoretically be developed. The array may also use frequency shading to create a single lobe of sound energy at a desired power level and polar pattern that is appropriate for the application.

FIVE-SOURCE END-FIRED ARRAY

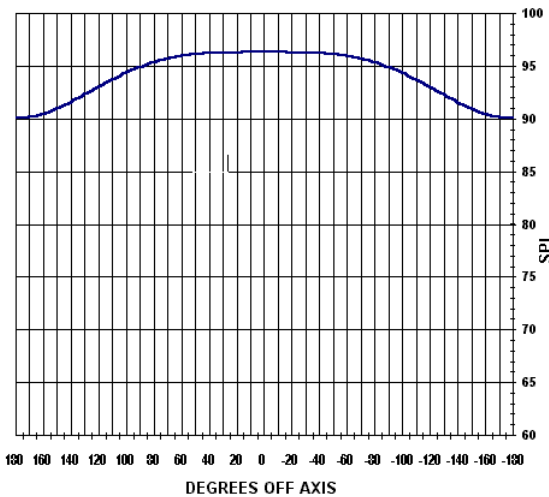

4' LENGTH/1' SPACING @ 70 HZ

FIVE-SOURCE END-FIRED ARRAY

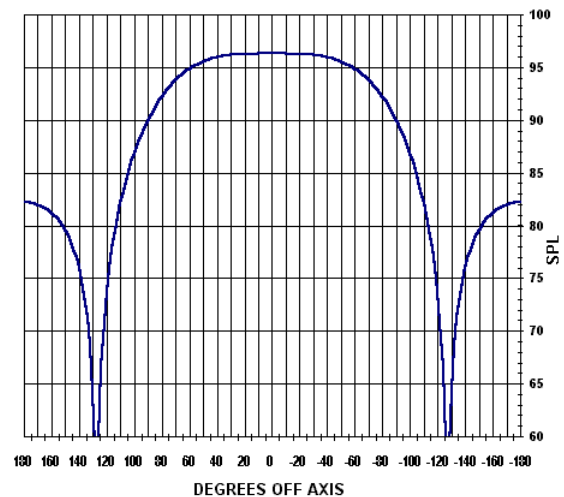

4' LENGTH/1' SPACING @ 140 HZ

FIVE-SOURCE END-FIRED ARRAY

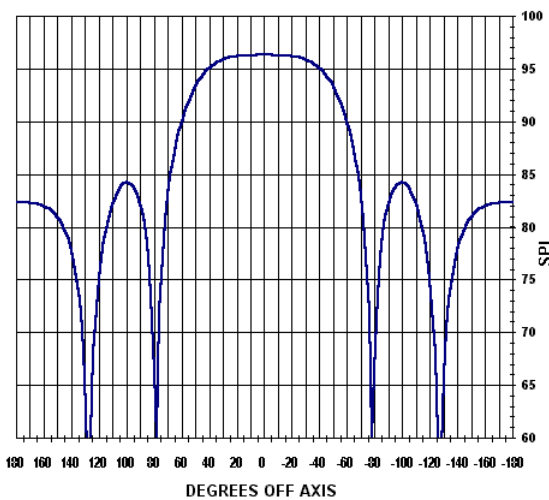

4' LENGTH/1' SPACING @ 280 HZ

FIVE-SOURCE END-FIRED ARRAY

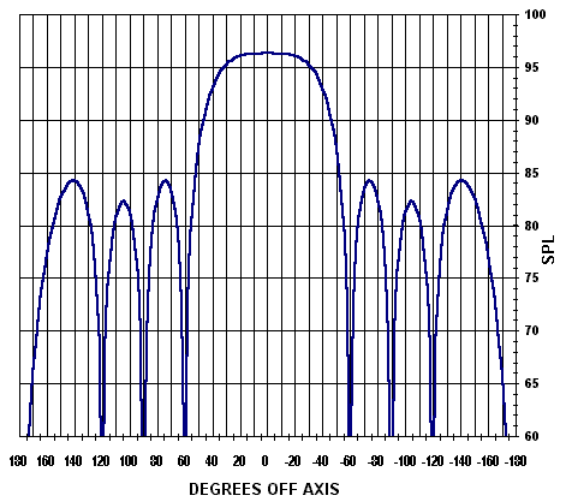

4' LENGTH/1' SPACING @ 450 HZ

APPLICATIONS

The concept of a forward-steered array is to create a three-dimensional array of loudspeakers and delay the drivers back to a point, line, or plane so that the energy from those drivers coherently sums in the direction perpendicular to the reference. The most challenging aspect of this concept is to create a device that works well acoustically by itself while retaining the ability to be physically positioned with other like devices in a modular system that allows them to be steered effectively throughout their band of operation.

JBL has developed three such systems; an 18" subwoofer system – PD 128, a 15" LF system – PD 125, and a 12" mid-bass system - PD 162. These systems were designed to maximize off-axis response throughout their band of operation. The particular applications they were created for demanded wide patterns – roughly 90 degrees, both horizontally and vertically. The current configuration of the PD 128 and PD 162 array modules allow for the creation of arrays with wide or narrow vertical patterns – depending on the configuration of the array.

The PD162 Based Low-Frequency Array:

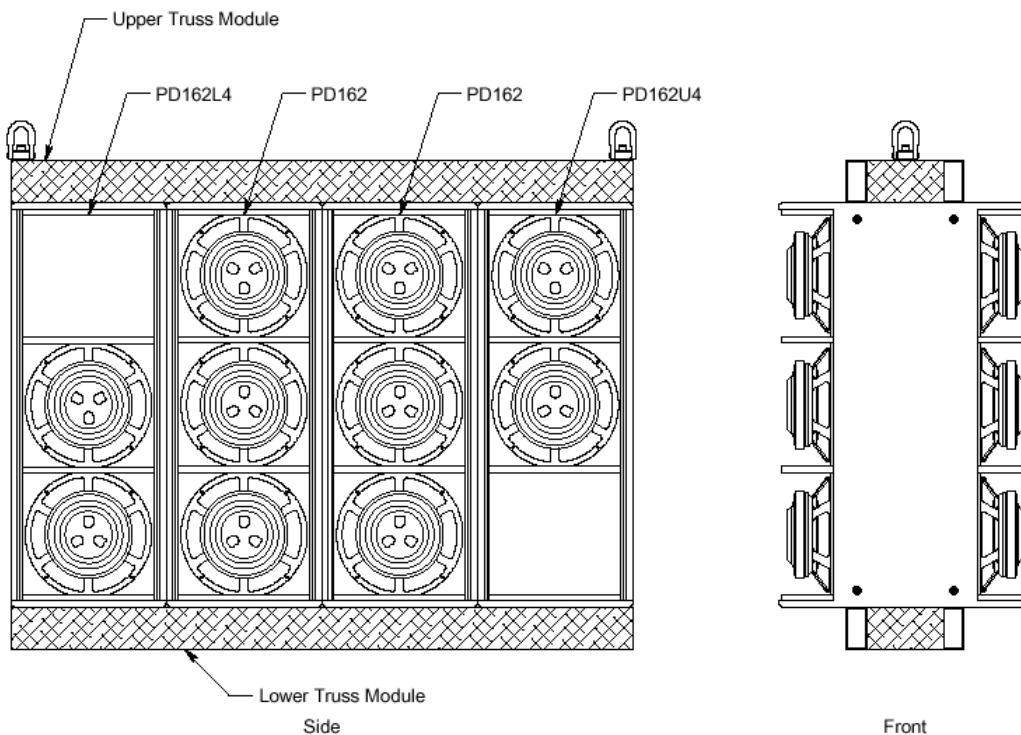

PD162 Family FSA Array
1x PD162L4, 2x PD162, 1x PD162U4
Showing Arrangement of Modules and Truss Components

The PD162 array development was an effort to pack low-frequency devices together as tightly as possible in a versatile configuration in order to create arrays that can suit a variety of applications. These arrays generally consist of four or more dual-driver array elements and are steered at an angle between 0 and -90 degrees to the array's reference axis. The steering is accomplished by delaying each LF element back to a reference plane that is normal to the direction that the array is being steered. The resulting sound energy is pushed forward, coherently summing in the direction of aiming and minimizing energy directed off-axis

The array is designed to be steerable in the vertical direction. Note that when the arrays are steered downward, the apparent spacing between drivers is reduced – a fortuitous event that pushes the theoretical upper working

frequency limit of the arrays upwards. So that the horizontal polar is kept wide, the horizontal driver to driver spacing is minimized. Horizontally, the array behaves like a spaced pair of sources. This configuration, when steered at an angle of 35 degrees, creates a polar response as shown.

This array was developed for use in an indoor arena at a typical cluster position. Note that the desired coverage sector, from 0 degrees to -90 degrees in this case, is covered smoothly with one contiguous energy lobe. Significantly, there is a very large amount of off-axis rejection. The combination of even response in the seating area and a high amount of off-axis energy attenuation has the potential of substantially increasing the quality of the low-frequency sound by maximizing the direct to reverberant energy.

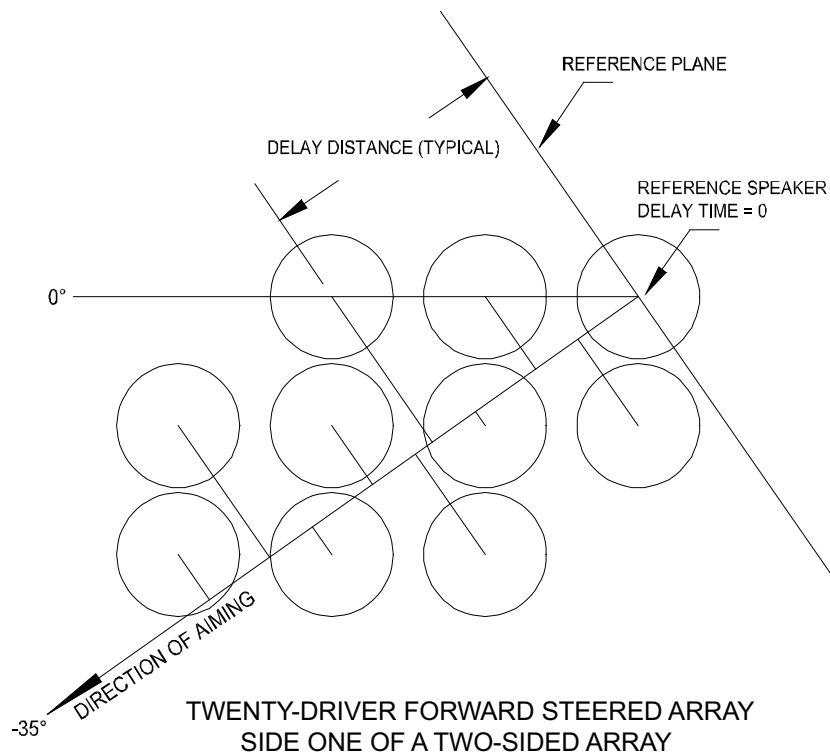

10-ELEMENT PD-162 ARRAY

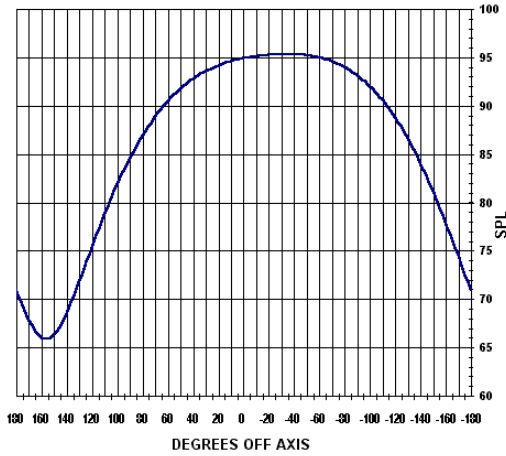

35 DEGREE DOWN ANGLE @ 125 HZ

10-ELEMENT PD-162 ARRAY

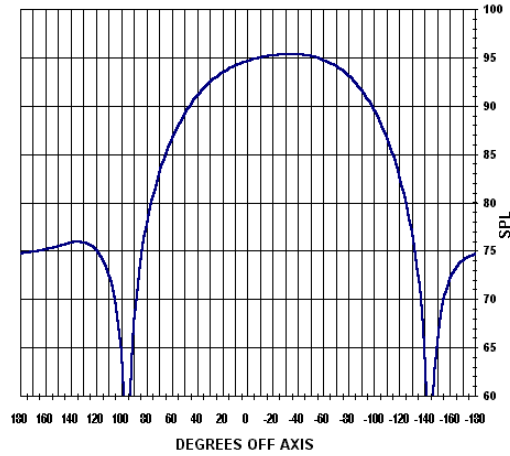

35 DEGREE DOWN ANGLE @ 160 HZ

10-ELEMENT PD-162 ARRAY

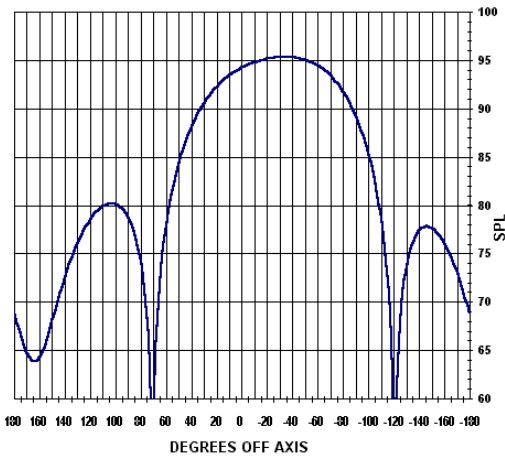

35 DEGREE DOWN ANGLE @ 200 HZ

10-ELEMENT PD-162 ARRAY

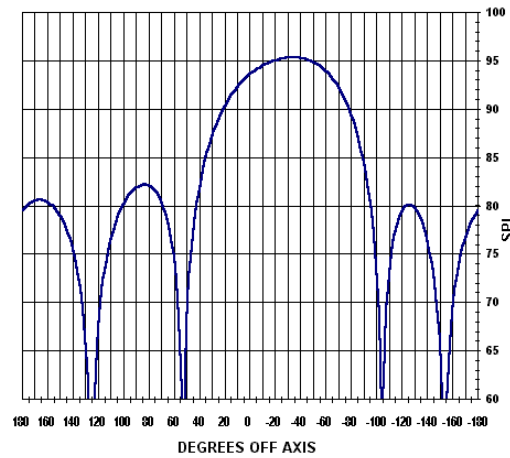

35 DEGREE DOWN ANGLE @ 250 HZ

The energy from each driver sums coherently in the direction of aiming and exhibits no phase shift or anomalies throughout the main energy lobe. A twenty-driver array as shown can conservatively develop 112 dB SPL continuous at 100 feet. The following response plot of the PD162 array includes phase (dashed). A zero-degree phase shift throughout the main lobe is typical for these arrays – that is, provided the array is not otherwise shaded or filtered on an element by element basis.

10-ELEMENT PD-162 ARRAY

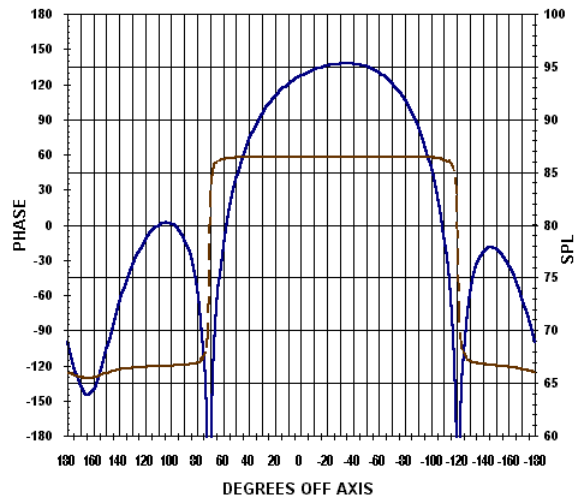

200 HZ with PHASE

This same configuration may, of course, be steered in other directions according to the application, 0 degrees and -50 degrees at 200 Hz is shown below:

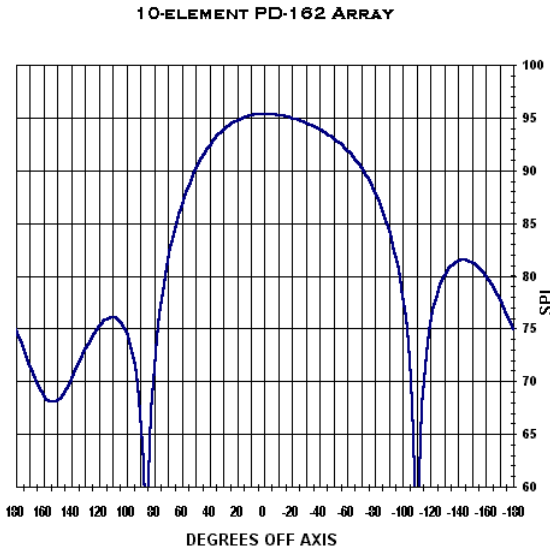

0 DEGREE DOWN ANGLE @ 200 HZ

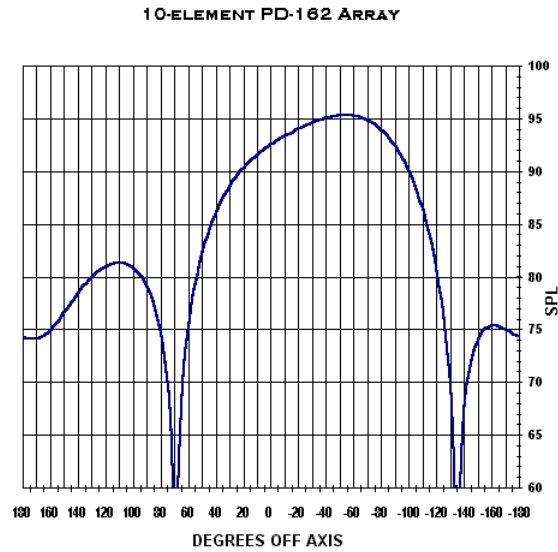

55 DEGREE DOWN ANGLE @ 200 HZ

This type of array may be expanded or reduced – depending on the power and directivity requirements of the system. A greater number of elements will allow a greater degree of off-axis rejection and provide greater SPL levels. To create a low-frequency array that has high power and wider vertical coverage, the array must be kept relatively small in that direction – at least at the upper end of its bandwidth. Conversely, a taller array will provide a narrower vertical pattern. Modules can be built in sizes other than those shown.

Because of the unusual orientation of the drivers, the array has an upper practical limit as the drivers themselves start to exhibit higher directivity. Also, a closed box with small volume was required so that the spacing between drivers could be minimized. These two issues give the array a practical working frequency range of 65 to 250 Hz, which works well in-between a subwoofer system such as the PD128 and the PD700 series of mid-high loudspeakers.

The PD 128 Based Subwoofer Array:

An array similar in concept has been created for use as a subwoofer based on the PD128 module. Due to the inherent size increase of the elements and the enclosure a different configuration is required. The larger spacing of the elements is acceptable since the wavelengths involved are larger. At these wavelengths – approximately 8 to 32 feet, the shadowing effect of the boxes is not problematic.

Again, the array is forward-steered at the angle desired by delaying each element back to a plane normal to the direction of aiming. Due to the geometry of the array, the main lobe will look slightly different at different steering angles. This array configuration has greater off-axis rejection when steered downward due to the increase in apparent array length. Shown below are six-element arrays at an aiming angle of 40 down which is suitable in a typical arena cluster position, working well to cover evenly between 0 and -90 degrees. Note the effectiveness of the steering and the desirable off-axis rejection.

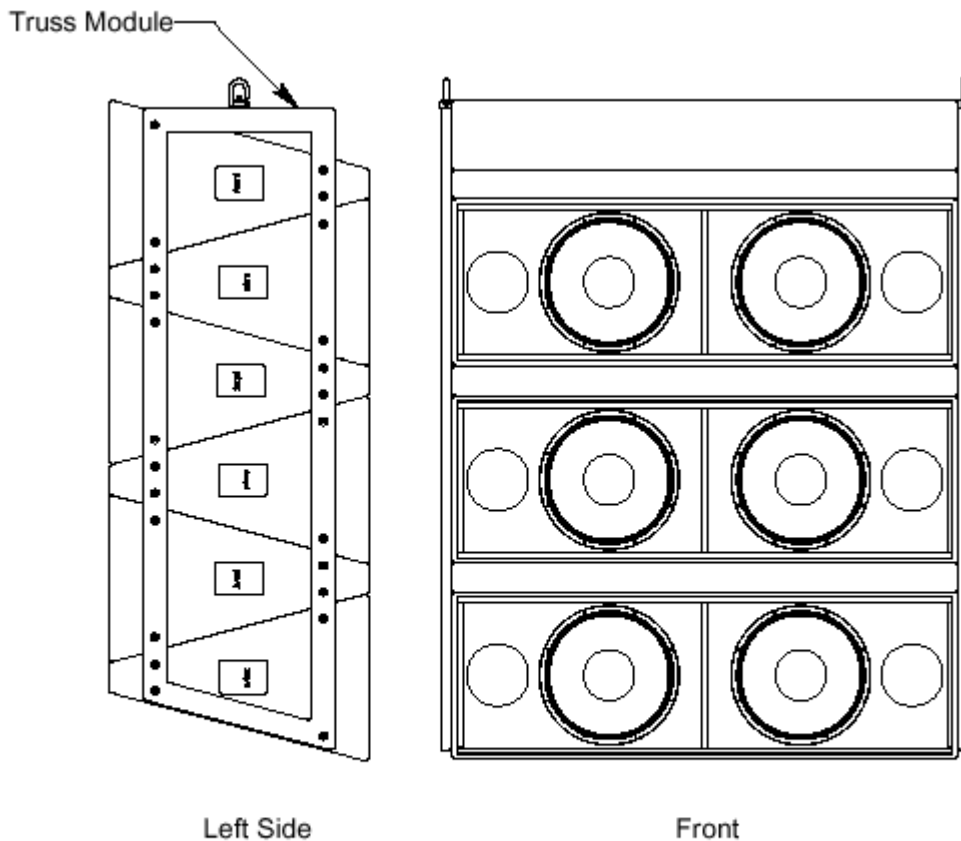

FSA Array of 6 PD128 Subwoofer Modules
Showing Arrangement of Modules and Truss Components

6-ELEMENT PD-128 ARRAY

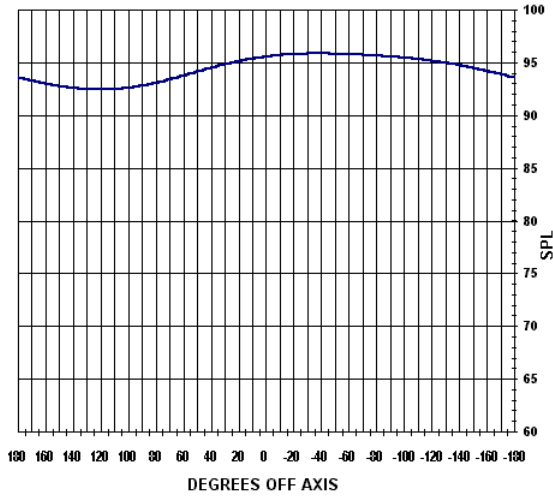

40 DEGREE DOWN ANGLE @ 40 HZ

6-ELEMENT PD-128 ARRAY

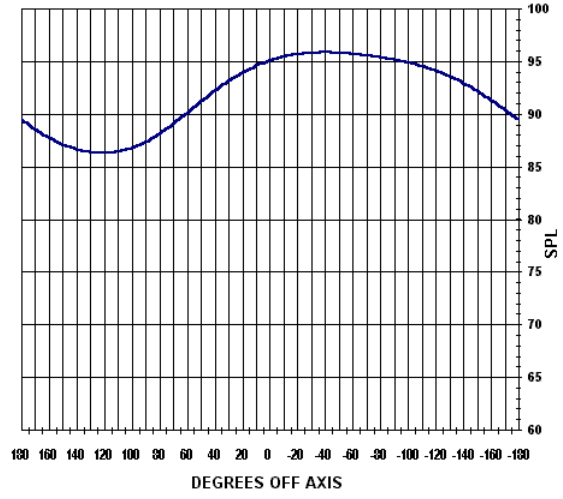

40 DEGREE DOWN ANGLE @ 63 HZ

6-ELEMENT PD-128 ARRAY

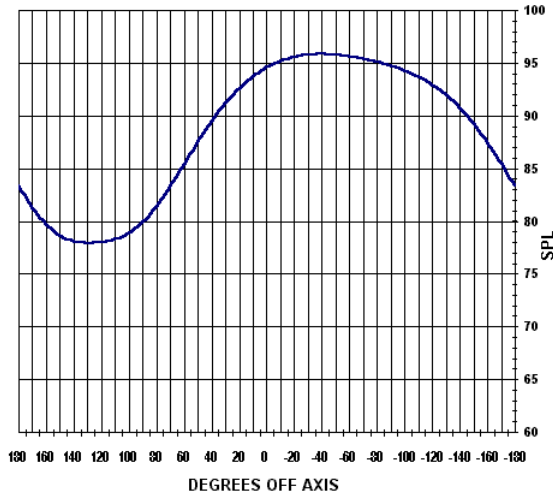

40 DEGREE DOWN ANGLE @ 80 HZ

6-ELEMENT PD-128 ARRAY

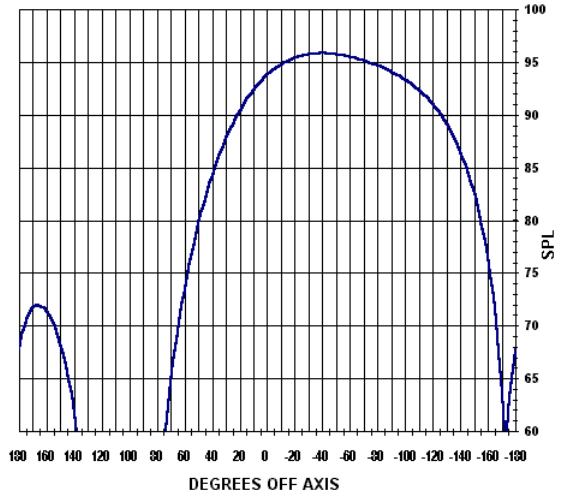

40 DEGREE DOWN ANGLE @ 100 HZ

The PD 125 High Q Low Frequency Array

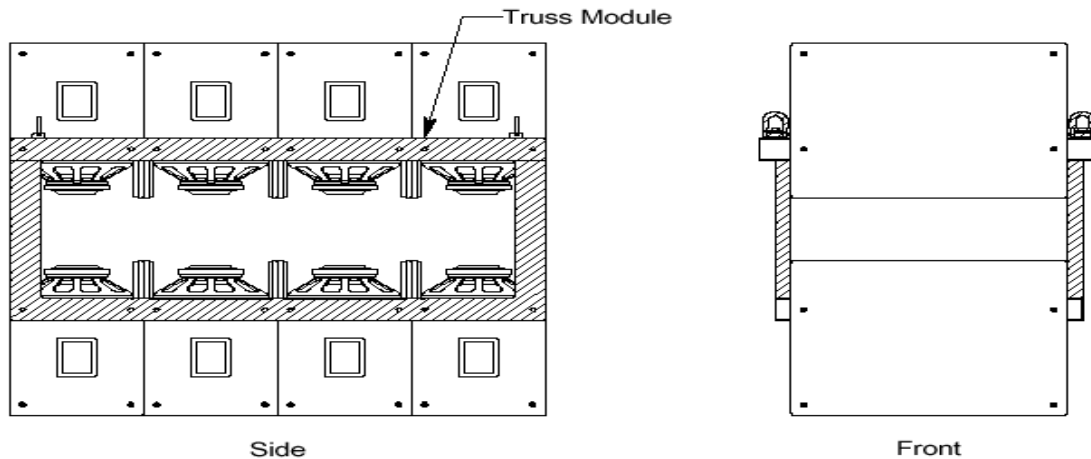

FSA Array of 8 PD125 Low Frequency Modules
Showing Arrangement of Modules and Truss Components

The PD125 array module, a dual 15" cabinet, was developed to create arrays that maximize power response and off-axis rejection while maintaining at least a 90-degree horizontal coverage pattern throughout its working bandwidth of 60Hz to 250 Hz. Its configuration is a simple extension of a multi-element end-fired array.

Frequency Shading:

The arrays described have not been tapered or frequency shaded in order to maintain the maximum available power throughout the bandwidth. This also maintains the highest total Q of the array at each frequency. However, it is often desirable to maintain a more consistent polar coverage pattern. Conventional frequency-shading techniques may be used to maintain the apparent height of the array with respect to the wavelength and can offset the inherent pattern narrowing at higher frequencies. This is especially applicable to the PD 162 arrays.

Over/Under Delay:

By scaling the delay time calculated for the drivers, the resultant lobe and associated off-axis attenuation may be manipulated. As described above, the basic driver delays are calculated by referencing them to a plane normal to the direction of aiming. Using "over-delay", that is, scaling these delay times by a factor greater than 1, creates greater attenuation near the lower working limit at the expense of lowering the upper working frequency. Conversely, "under-delaying", or multiplying these numbers by a number less than 1, will extend the upper working frequency at the expense of poorer low-frequency performance. Also, using under-delay has the sometimes-favorable side effect of widening the main lobe at the higher frequencies.

Shown are plots of the same subwoofer arrays described above over-delayed by a factor of 1.3 at 63 and 100 Hz. The off-axis rejection is greater at 63 Hz at the expense of higher side lobes at 100 Hz.

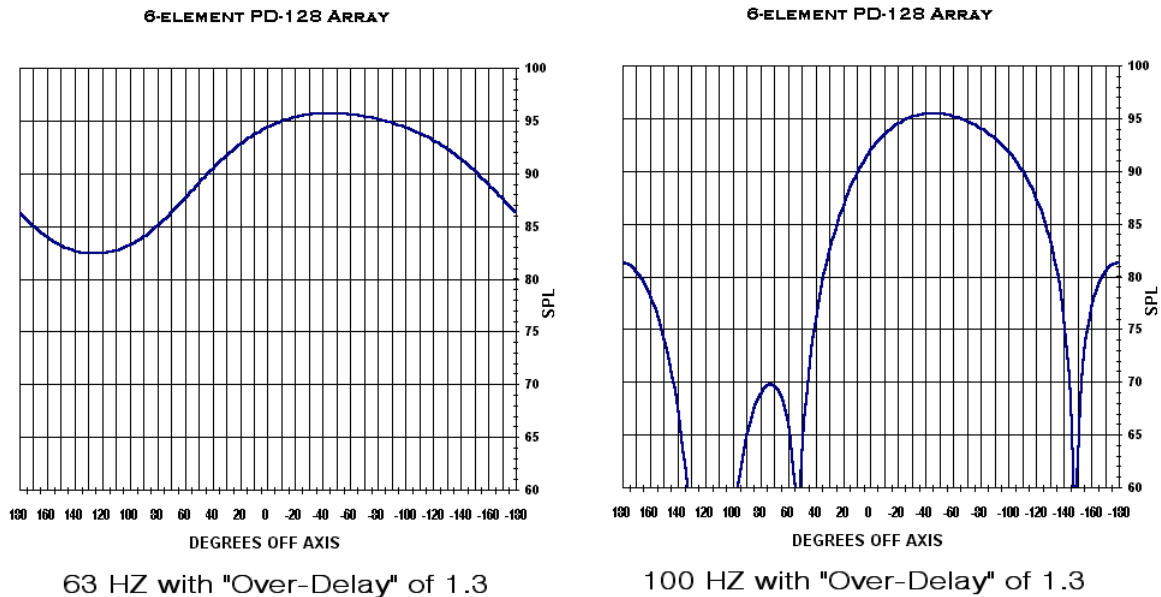

SUMMARY

There are several advantages of forward-steered arrays. Using only delay between the loudspeaker elements creates high-powered arrays that coherently sum on axis while providing a high degree of off-axis rejection. Through the optional addition of frequency shadings, solutions can be devised to further improve the consistent polar coverage of the main lobe of energy or otherwise optimize its response. The systems are also extensible as can be put together in a large number of physical configurations depending on the application. And, in addition to the technical features of the arrays described, the arrays are compact with respect to their output power capabilities.

These arrays provide a powerful alternative to conventionally configured low-frequency systems and have a unique set of capabilities. These configurations may also be customized and expanded to address and refine a great variety of applications.

¹ Olson, H. F., *Acoustical Engineering*, Copyright 1991, Professional Audio Journals, Inc. p. 38-39 (first published by D. Van Nostrand Company, Inc., 1957).



JBL Professional
8500 Balboa Boulevard
Northridge, California 91329 U. S. A.

HA Harman International Company