



Scan for full manual

AFM-20DSP Quick Start Guide

This guide helps you install and use your AFM-20DSP for the first time.

Go to www.kramerav.com/downloads/AFM-20DSP to download the latest user manual and check if firmware upgrades are available.

Step 1: Check what's in the box

- ✓ AFM-20DSP 20 Port Audio Matrix
 - ✓ 1 Power cord
- ✓ 1 Set of rack ears
 - ✓ 4 Rubber feet
- ✓ 1 Quick start guide

Step 2: Get to know your AFM-20DSP

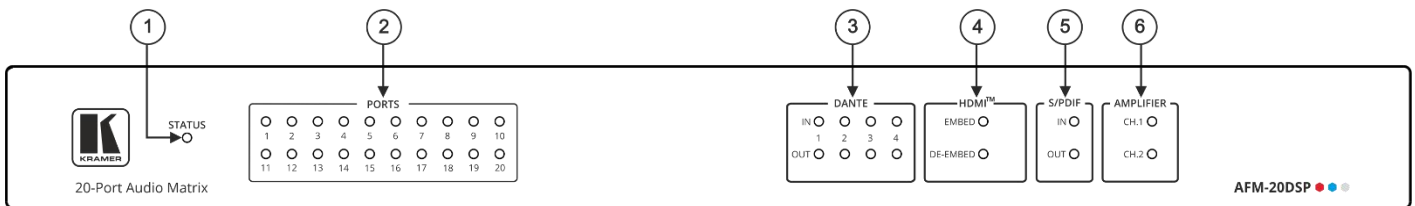

The terms HDMI, HDMI High-Definition Multimedia Interface, and the HDMI Logo are trademarks or registered trademarks of HDMI Licensing Administrator, Inc.

#	Feature	Function	
1	STATUS LED	<p>Indicates system status:</p> <ul style="list-style-type: none"> • Almost 3 cycles of red/blue/off/green LEDs flashing in sequence for about 30 seconds when system is starting up, and the application has not been launched yet. • Flashing green when application is initializing. • Green when system is ready for operation. 	
2	PORTS LEDs (1 to 20)	<p>Indicate port status:</p> <ul style="list-style-type: none"> • Green when an input signal is present, and the port is defined as line in. • White when defined as line out. • Blue when defined as mic in. • Red when in clipping state. • Orange when in limiting state. • Off when there is no signal on the input. 	
3	IN OUT DANTE™ LEDs (1 to 4)	<p>Indicate Dante signal status:</p> <ul style="list-style-type: none"> • Green when a signal is detected. • Red when clipping occurs. • Orange when in Limiting state. • Off when no signal is detected. 	
4	HDMI™ LEDs	EMBED	Lights green when an analog audio signal is associated with the HDMI OUT signal. Otherwise remains OFF.
		DE-EMBED	Lights green when the HDMI IN audio signal is present. Otherwise remains OFF.
5	IN OUT S/PDIF LEDs	<p>Indicate S/PDIF status:</p> <ul style="list-style-type: none"> • Green when a signal is detected. • Off when no signal is detected. <p>i If a signal is detected only on one channel, either left only or right only, the status LED lights green.</p>	
6	CH 1(L)/CH 2(R) AMPLIFIER LEDs	<p>Indicates amplifier signal status:</p> <ul style="list-style-type: none"> • Green when a signal is detected. • Off when no signal is detected. <p>In the web page, Ch1 and CH2 are referred to as AMP 1 and AMP 2, respectively.</p>	

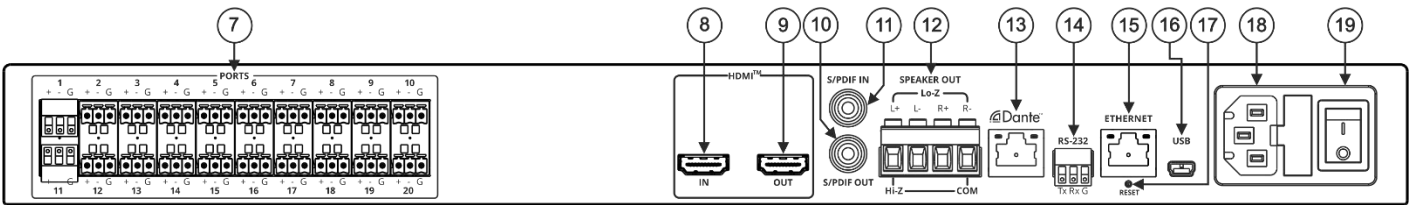

#	Feature	Function
7	PORTS 3-pin Terminal Block Connectors (1 to 20)	Interchangeable balanced mono audio ports. Connect to an audio source or acceptor in one of 7 selectable I/O configurations: 16x4, 14x6, 12x8, 10x10, 8x12, 6x14, 4x16 Each port can be defined as line in, mic in, mic + 48V in, or line out.
8	HDMI™ IN Connector	Connect to an HDMI source for de-embedding the audio signal (the video signal is passed through to the output).
9	HDMI™ OUT Connector	Connect to an HDMI acceptor for embedding an audio signal from the matrix.
10	S/PDIF OUT RCA Connector	Connect to a digital stereo audio acceptor.
11	S/PDIF IN RCA Connector	Connect to a digital stereo audio source.
12	SPEAKER OUT	Outputs two selected audio signals in two channels. For Lo-Z: connect stereo output to Lo-Z speakers: L+ and L- to the left speaker; R+R- to the right speaker. For Hi-Z (70V or 100V): connect Hi-Z and COM to mono Hi-Z speakers.
13	Dante PoE RJ-45 Port	Connect to Dante audio via the network. Provides 4 Tx channels and 4 Rx channels. By default, DHCP is enabled.
14	RS-232 3-pin Terminal Block Connector	Connect to a PC/serial controller to control the device.
15	ETHERNET RJ-45 Connector	Connect to a PC via a LAN to control the device and for firmware upgrade.
16	Mini USB Connector	Connect to your PC to control the device.
17	RESET Recessed Button	Press and hold for about 5 seconds to reset the configuration to its default parameters.
18	Mains Power Connector and Fuse	Plug in the power cord.
19	POWER Illuminated Power Switch	Turn the device on and off.

Step 3: Mount AFM-20DSP

To rack mount the machine, attach both rack ears (by removing the screws from each side of the machine and replacing those screws through the rack ears) or place the machine on a table.

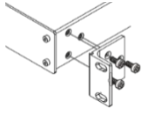

- Ensure that the environment (e.g., maximum ambient temperature & air flow) is compatible for the device.
- Avoid uneven mechanical loading.
- Appropriate consideration of equipment nameplate ratings should be used for avoiding overloading of the circuits.
- Reliable earthing of rack-mounted equipment should be maintained.

Step 4: Connect the inputs and outputs

Always switch OFF the power on each device before connecting it to your **AFM-20DSP**.

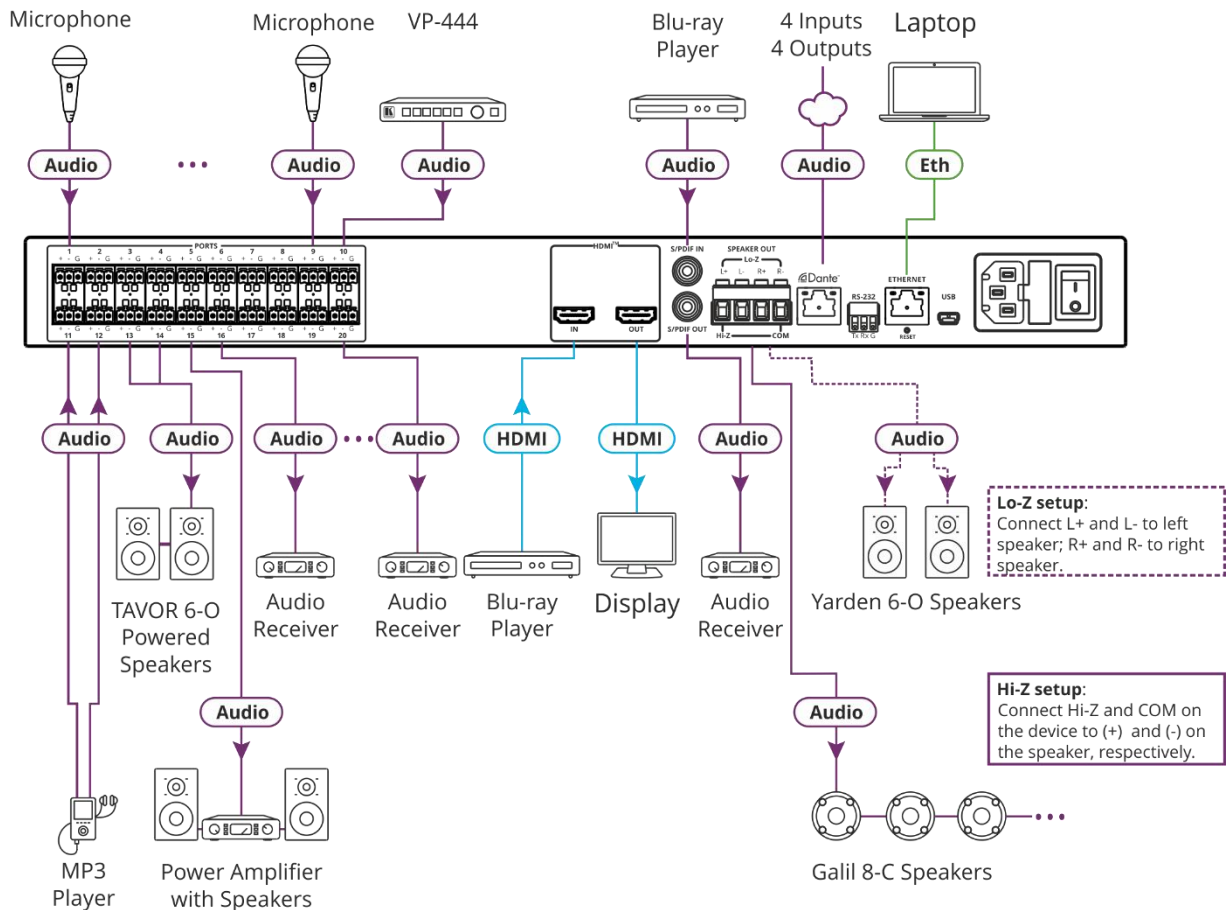

For optimum range and performance use the recommended Kramer cables available at www.kramerav.com/product/AFM-20DSP. Using third-party cables may cause damage!

Step 5: Connect the power

Connect the power cord to **AFM-20DSP** and plug it into the mains electricity.

Safety Instructions (See www.kramerav.com for updated safety information)

Caution:

- There are no operator serviceable parts inside the unit.

Warning:

- Use only the power cord that is supplied with the unit.
- Disconnect the power and unplug the unit from the wall before installing.
- Do not open the unit. High voltages can cause electrical shock! Servicing by qualified personnel only.
- To ensure continuous risk protection, replace fuses only according to the rating specified on the product label which located on the bottom of the unit.

Step 6: Operate the AFM-20DSP

Operate **AFM-20DSP** via:

- Embedded web pages via the Ethernet.
- RS-232 serial commands transmitted by a touch screen system, PC, or other serial controller.

RS-232 Control / Protocol 3000

Baud Rate:	115,200	Parity:	None
Data Bits:	8	Command Format:	ASCII
Stop Bits:	1		

Example: (adjust the amplified audio from analog audio 1 to -10dB):
#x-aud-lvl out.amplified_audio.1.audio.1,-10

Default Ethernet Parameters

IP Address:	192.168.1.39	UDP Port #:	50000
Subnet mask:	255.255.0.0	TCP Port #:	5000
Gateway:	192.168.0.1	Security User/Password	Admin/Admin

Factory Reset

Recessed Button	Press and hold for 5 seconds to reset the configuration to its default parameters.
Protocol 3000:	"#factory" command.
Web Pages:	In the Settings page, click Reset.

Using the embedded web pages

To route an input to an output / outputs:

In the **DSP Matrix** page, click the lower area of cross-point buttons to connect an audio input (analog, Dante, HDMI audio signal, S/PDIF or a signal generator) to one or several outputs (analog, Dante, HDMI or S/PDIF). The button lights green.

Click the dB area on a cross-point button to set the output volume.

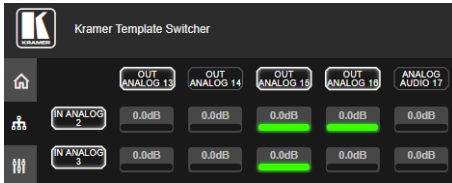

To process an input/output signal:

In the **DSP Main** page, process each input and output audio signal and view the routing state of the matrix. Click **AMP** to select the amplifier audio signal.

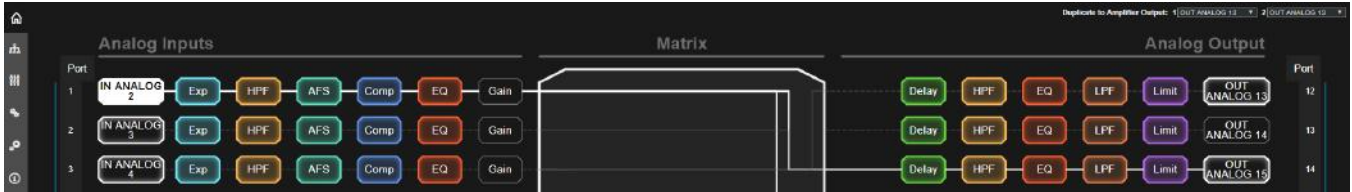

To mix the audio signals:

In the **DSP Mixer** page, control the audio level (or mute) each input/output, define an analog input as line or mic, and so on. You can also store/recall snapshots of the current mixing setting.

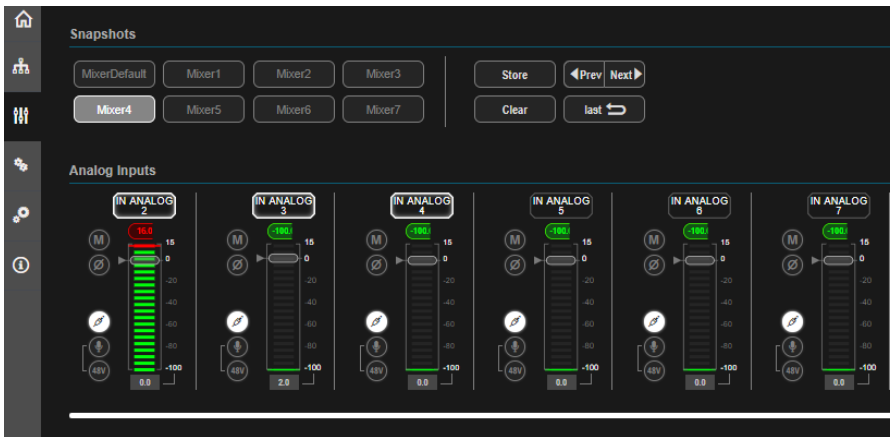

To define the audio and video settings:

In the **A/V Settings** page, select the I/O port configuration, save and load system presets, define Dante and Ethernet parameters and set HDMI labels and input pattern.

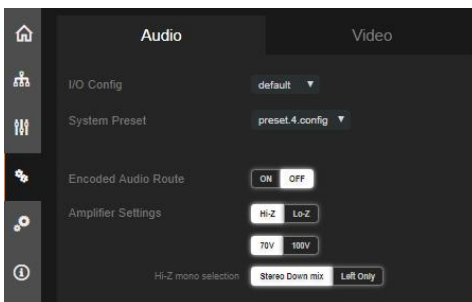

To define device parameters:

In the **Settings** page, enter the device name, Ethernet settings, firmware upgrade, date and time settings or perform a factory reset.