

USER MANUAL

MODEL:

KN-100

Kramer Network Powered Server



Contents

Introduction	1
Getting Started	1
Overview	2
Defining KN-100 Kramer Network Powered Server	4
Installing KN-100 in a Rack	5
Connecting KN-100	6
Connecting KN-100 via the Ethernet Port	7
Connecting the Ethernet Port Directly to a PC	7
Connecting the Ethernet Port via a Network Hub or Switch	9
Control Configuration via the Ethernet Port	9
Preparing KN-100 for Operation	10
Technical Specifications	12

Introduction

Welcome to Kramer Electronics! Since 1981, Kramer Electronics has been providing a world of unique, creative, and affordable solutions to the vast range of problems that confront the video, audio, presentation, and broadcasting professional on a daily basis. In recent years, we have redesigned and upgraded most of our line, making the best even better!

Getting Started

We recommend that you:

- Unpack the equipment carefully and save the original box and packaging materials for possible future shipment.
- Review the contents of this user manual.



Go to www.kramerav.com/downloads/KN-100 to check for up-to-date user manuals, application programs, and to check if firmware upgrades are available (where appropriate).

Achieving the Best Performance

- Use only good quality connection cables (we recommend Kramer high-performance, high-resolution cables) to avoid interference, deterioration in signal quality due to poor matching, and elevated noise levels (often associated with low quality cables).
- Do not secure the cables in tight bundles or roll the slack into tight coils.
- Avoid interference from neighboring electrical appliances that may adversely influence signal quality.
- Position your Kramer **KN-100** away from moisture, excessive sunlight and dust.

Safety Instructions



Caution:

- This equipment is to be used only inside a building. It may only be connected to other equipment that is installed inside a building.
- There are no operator serviceable parts inside the unit.



Warning:

- Use only the power cord that is supplied with the unit.
- Disconnect the power and unplug the unit from the wall before installing.
- Do not open the unit. High voltages can cause electrical shock! Servicing by qualified personnel only.
- To ensure continuous risk protection, replace fuses only according to the rating specified on the product label which located on the bottom of the unit.

Recycling Kramer Products

The Waste Electrical and Electronic Equipment (WEEE) Directive 2002/96/EC aims to reduce the amount of WEEE sent for disposal to landfill or incineration by requiring it to be collected and recycled. To comply with the WEEE Directive, Kramer Electronics has made arrangements with the European Advanced Recycling Network (EARN) and will cover any costs of treatment, recycling and recovery of waste Kramer Electronics branded equipment on arrival at the EARN facility. For details of Kramer's recycling arrangements in your particular country go to our recycling pages at www.kramerav.com/support/recycling.

Overview

Congratulations on purchasing your Kramer **KN-100 Kramer Network Powered Server**. **KN-100** is a 19" 1U server pre-installed with Kramer Network, an innovative enterprise management platform that lets IT and AV managers easily configure and manage the entire Kramer AV/IP product range and Dante™ devices from any single point, anywhere in the world. With a 6th generation Intel® Xeon® E3-1240 v5 Xeon (4 Cores, 8M Cache, 3.50 GHz) processor, 2x 4GB DDR4 RAM, an 80GB SSD hard drive, Windows® 10 operating system, **KN-100** is designed to maximize the features and benefits of Kramer Network.

KN-100 provides exceptional quality and advanced and user-friendly operation and control.

Exceptional Quality

- Automated device detection – The platform instantly and automatically identifies devices in the network, reducing configuration time.
- No programming required – Install and start using the platform in minutes with no need for programming.
- Scales to any size installation – Support hundreds of devices simultaneously.

Advanced and User-friendly Operation

- Multi-language, user-friendly web-based GUI – Easily access and use from anywhere, anytime.
- Integrated Maestro room automation – For use with any device or location.
- Remote maintenance – No need for on-site visits.

- Virtual matrix – Click and connect any source to any destination and create predefined scenarios for video and Dante™ streams.
- Enhanced Security – With intuitive user access management and LDAP integration, Kramer Network allows only certain users to access specific audio or video sources, rooms and pre-defined scenarios
- Visual & topology AV system mapping – Easily drill down to a specific network, site, building or room to start managing AV devices.
- System & connection status at a glance – Quickly identify critical issues in the network and see logical-video-link status at a glance.

Defining KN-100 Kramer Network Powered Server

This section defines KN-100.

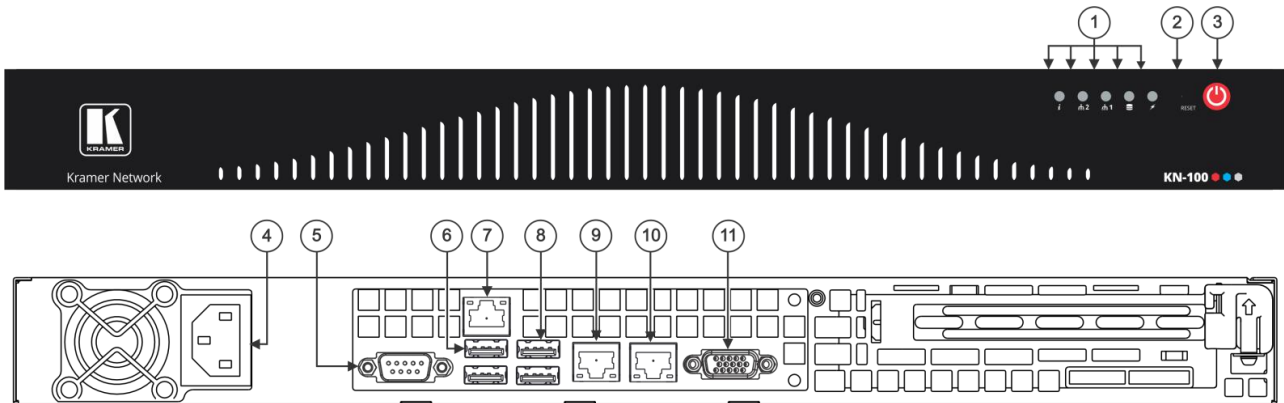







Figure 1: KN-100 Kramer Network Powered Server

#	Feature	Function
①	Indicator LEDs	 Flashes to indicate fan failure. Lights continuously to indicate system overheat.
		 Flashes when there is network activity on LAN port 2.
		 Flashes when there is network activity on LAN port 1.
		 Flashes to indicate hard drive activity.
		 Lights when the device is powered.
②	Reset Button	Use to reboot the system.
③	Power Button	Use to toggle setting the device to standby mode / turning the device on. To turn the power off, disconnect the power connector from the mains.
④	Power Socket	Connect to the power cord and to the mains electricity.
⑤	RS-232 9-pin D-sub Connector	Connect to a system controller.
⑥	USB 2.0 Ports (2)	Connect to a keyboard and mouse (if required).
⑦	IPMI (Intelligent Platform Management Interface) LAN RJ-45 Connector	Use for remote access.
⑧	USB 3.0 Ports (2)	Connect to USB devices.
⑨	LAN 1 ETHERNET RJ-45 Connector	Connect to the Ethernet.
⑩	LAN 2 ETHERNET RJ-45 Connector	Connect to the Ethernet.
⑪	VGA 15-pin HD Connector	Connect to a display.

Installing KN-100 in a Rack

This section provides instructions for rack mounting the **KN-100**. Before installing in a rack, verify that the environment is within the recommended range:

- Operation temperature – 0° to 40°C (32 to 104°F).
- Storage temperature – -40° to +70°C (-40 to +158°F).
- Humidity – 10% to 90%, RHL non-condensing.



When installing on a 19" rack, avoid hazards by taking care that:

- It is located within recommended environmental conditions. Operating ambient temperature of a closed or multi-unit rack assembly may exceed ambient room temperature.
- Once rack mounted, there is enough air flow around **KN-100**.
- The **KN-100** is placed upright in the correct horizontal position.
- You do not overload the circuit(s). When connecting the **KN-100** to the supply circuit, overloading the circuits may have a detrimental effect on overcurrent protection and supply wiring. Refer to the appropriate nameplate ratings for information. For example, for fuse replacement, see the value printed on the product label.
- The **KN-100** is earthed (grounded) and connected only to an electricity socket with grounding. Pay particular attention when electricity is supplied indirectly (for example, when the power cord is not plugged directly into the wall socket but to an extension cable or power strip). Use only the supplied power cord.

To rack-mount the KN-100:

1. Attach both ear brackets to the **KN-100**:
Remove the screws from each side of the **KN-100**, and replace them through the ear brackets.
2. Place the ears of the **KN-100** against the rack rails and insert the appropriate screws (not provided) through each of the holes in the rack ears.

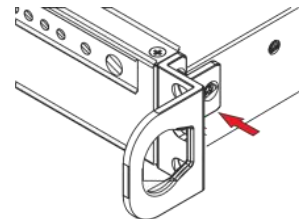

- Detachable rack ears can be removed for desktop use.
- Always mount the **KN-100** in the rack before connecting any cables or power.

Connecting KN-100



Always switch off the power to each device before connecting it to your **KN-100**. After connecting your **KN-100**, connect its power and then switch on the power to each device.

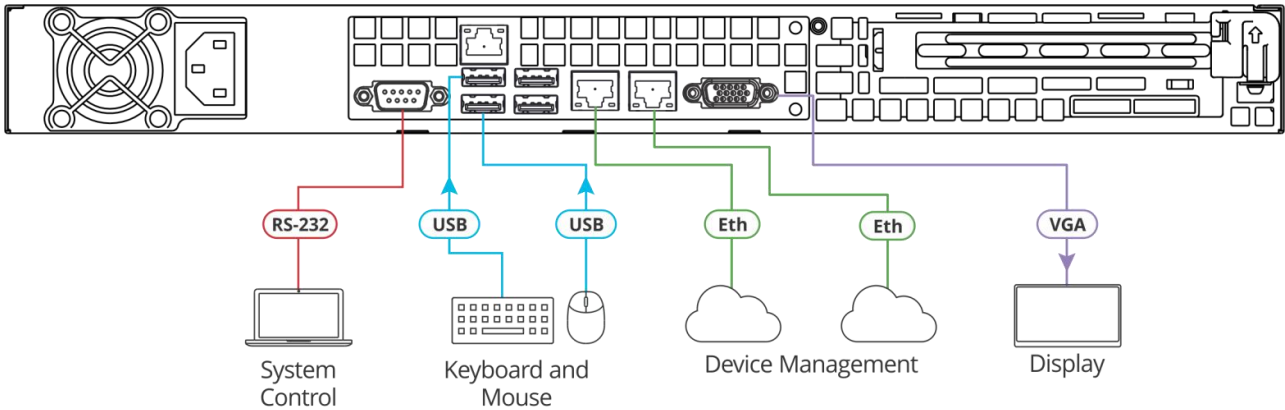

Figure 2: Connecting to the KN-100 Rear Panel

To connect KN-100 (as illustrated in Figure 2):

1. Connect a laptop (for system control) to the RS-232 9-pin D-sub connector (5).
2. Connect a keyboard and mouse to the USB ports (6).
3. Connect the following ports to the Ethernet:
 - LAN 1 RJ-45 port (9) to a network.
 - LAN 2 RJ-45 port (10) to a network.
4. Connect the VGA 15-pin HD connector (11) to a display.
5. Connect the power cord to the power socket (4) and to the mains electricity. We recommend that you use only the power cord that is supplied with this machine.

Connecting KN-100 via the Ethernet Port

You can connect to the KN-100 via Ethernet using either of the following methods:

- [Connecting the Ethernet Port Directly to a PC](#) on page 7.
- [Connecting the Ethernet Port via a Network Hub or Switch](#) on page 9.



If you want to connect via a router and your IT system is based on IPv6, speak to your IT department for specific installation instructions.

Connecting the Ethernet Port Directly to a PC

You can connect the Ethernet port of the KN-100 directly to the Ethernet port on your PC using a crossover cable with RJ-45 connectors.



This type of connection is recommended for identifying the KN-100 with the factory configured default IP address.

After connecting the KN-100 to the Ethernet port, configure your PC as follows:

1. Click **Start > Control Panel > Network and Sharing Center**.
2. Click **Change Adapter Settings**.
3. Highlight the network adapter you want to use to connect to the device and click **Change settings of this connection**.

The Local Area Connection Properties window for the selected network adapter appears as shown in [Figure 3](#).

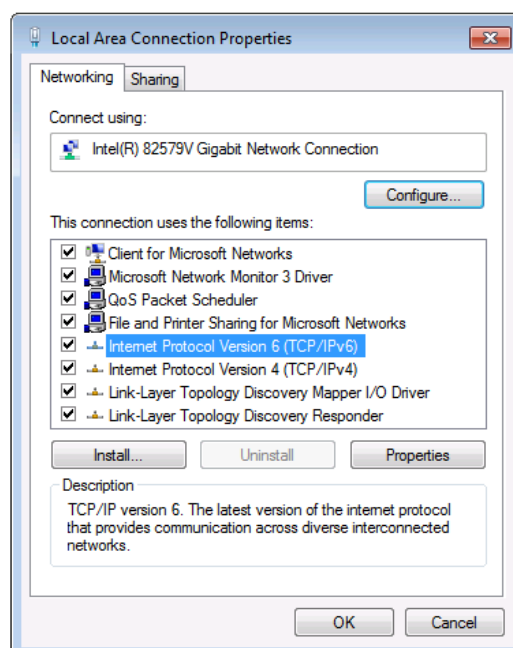

Figure 3: Local Area Connection Properties Window

4. Highlight either **Internet Protocol Version 6 (TCP/IPv6)** or **Internet Protocol Version 4 (TCP/IPv4)** depending on the requirements of your IT system.
5. Click **Properties**.
The Internet Protocol Properties window relevant to your IT system appears as shown in [Figure 4](#) or [Figure 5](#).

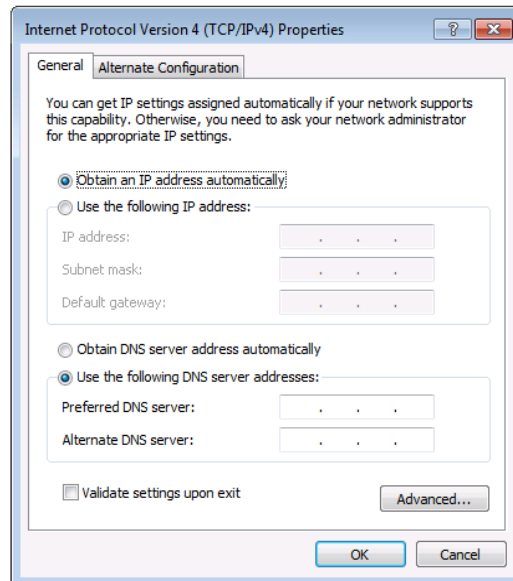

Figure 4: Internet Protocol Version 4 Properties Window

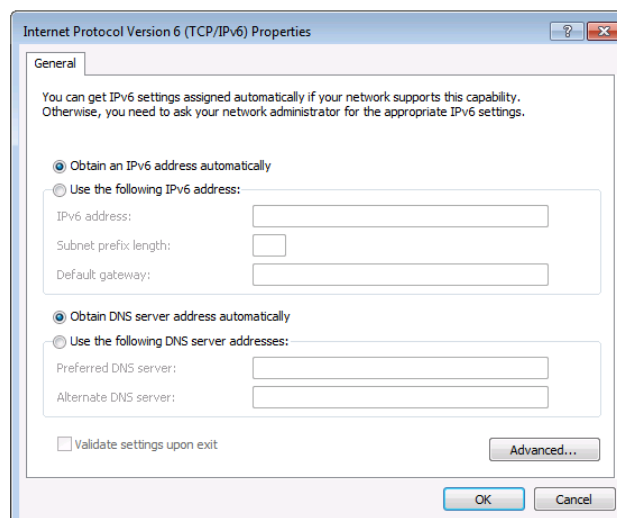

Figure 5: Internet Protocol Version 6 Properties Window

6. Select **Use the following IP Address** for static IP addressing and fill in the details as shown in [Figure 6](#).
For TCP/IPv4 you can use any IP address in the range 192.168.1.1 to 192.168.1.255 (excluding 192.168.1.39) that is provided by your IT department.

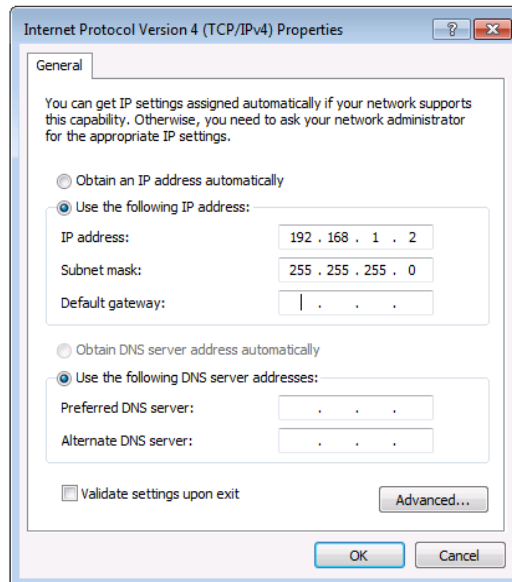

Figure 6: Internet Protocol Properties Window

7. Click **OK**.
8. Click **Close**.

Connecting the Ethernet Port via a Network Hub or Switch

You can connect the Ethernet port of the **KN-100** to the Ethernet port on a network hub or using a straight-through cable with RJ-45 connectors.



Since **KN-100** incorporates an embedded Layer 2 Ethernet switch, we recommend that this port only is connected to the network.

Peripheral devices that are connected to **KN-100** via HDBT ports and have Ethernet ports as well, should not be connected to the network and can be used for Ethernet IP clients.

Connecting the Ethernet port of the HDBT transmitters/receivers to the network switch port in conjunction with Ethernet port network connection on the **KN-100**, will cause network loops that may cause Ethernet switch network breakdown.

Control Configuration via the Ethernet Port

To control several units via Ethernet, connect the Master unit (Device 1) via the Ethernet port to the Ethernet port of your PC. Use your PC provide initial configuration of the settings (see [Connecting KN-100 via the Ethernet Port](#) on page 7).

Preparing KN-100 for Operation

This section describes how to verify that **KN-100** is ready for operation.

To prepare **KN-100**:

1. Connect power to the device and press the power button (3).
The following window appears:



Figure 7: Desktop View

2. Wait for the system to initialize.



You must wait 5 minutes for the system to initialize.
Failing to wait 5 minutes may cause the system to crash.

3. Open Google Chrome. Kramer Network access window opens.

4. Type <IP Server>. The Kramer Network window opens:

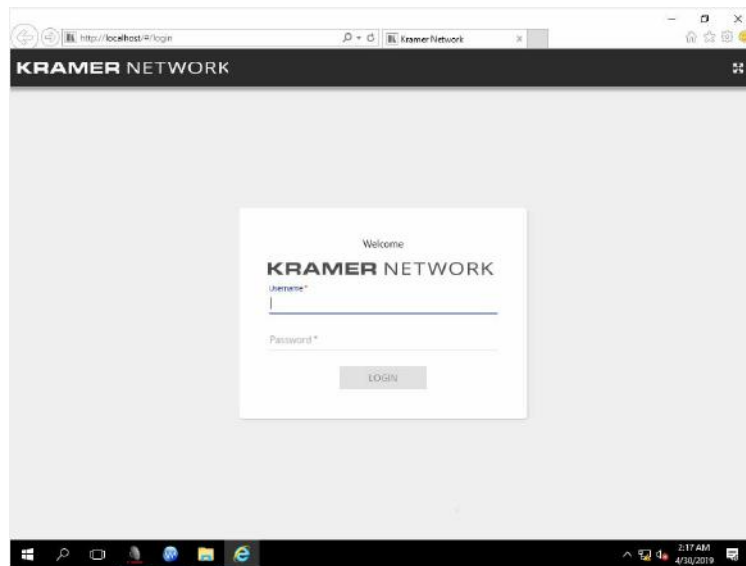



Figure 8: Kramer Network Welcome Page

5. Enter Username and Password (Super and 12345, by default).

6. Click **LOGIN**.

Kramer Network is ready to use.

Go to www.kramerav.com/downloads/KN-100 for operating **Kramer Network** or click  after **Kramer Network** uploads to access the tutorial documents.

Technical Specifications

Output	VGA	On a 15-pin HD connector
Ports	RS-232	On a 9-pin D-sub connector
	2 USB 2.0	On USB type-A ports
	2 USB 3.0	On USB type-A ports
Controls	3 Ethernet	On RJ-45 connectors
	Indication LEDs	Fan failure, network activity (LAN 1 and LAN 2), hard-drive activity, power
Buttons	Buttons	Reboot the system, power
	Processor	3.5GHz quad core
Server	Main Memory	8GB, high speed
	Storage	60GB, solid-state drive
Power	Consumption	100-240V AC, 600VA max.
	Source	100-240V AC, 5A
Environmental Conditions	Operating Temperature	0° to +40°C (32° to 104°F)
	Storage Temperature	-40° to +70°C (-40° to 158°F)
	Humidity	10% to 90%, RHL non-condensing
Regulatory Compliance	Safety	CE
	Environmental	RoHs, WEEE
Enclosure	Size	1U
	Type	Aluminum
	Cooling	Fans
General	Net Dimensions (W, D, H)	44cm x 37.2cm x 4.5cm (17.3" x 14.6" x 1.8")
	Shipping Dimensions (W, D, H)	52.6cm x 47.5cm x 18.4cm (20.7" x 18.7" x 7.2")
	Net Weight	5.7kg (12.6lbs)
	Shipping Weight	7.7kg (17lbs) approx.
	Kramer Network	Default user: Super Default password: 12345
Accessories	Included	2 Power cord types (US + European), VGA to HDMI™ cable adapter, rack ears
Specifications are subject to change without notice at www.kramerav.com		

The warranty obligations of Kramer Electronics Inc. ("Kramer Electronics") for this product are limited to the terms set forth below:

What is Covered

This limited warranty covers defects in materials and workmanship in this product.

What is Not Covered

This limited warranty does not cover any damage, deterioration or malfunction resulting from any alteration, modification, improper or unreasonable use or maintenance, misuse, abuse, accident, neglect, exposure to excess moisture, fire, improper packing and shipping (such claims must be presented to the carrier), lightning, power surges, or other acts of nature. This limited warranty does not cover any damage, deterioration or malfunction resulting from the installation or removal of this product from any installation, any unauthorized tampering with this product, any repairs attempted by anyone unauthorized by Kramer Electronics to make such repairs, or any other cause which does not relate directly to a defect in materials and/or workmanship of this product. This limited warranty does not cover cartons, equipment enclosures, cables or accessories used in conjunction with this product.

Without limiting any other exclusion herein, Kramer Electronics does not warrant that the product covered hereby, including, without limitation, the technology and/or integrated circuit(s) included in the product, will not become obsolete or that such items are or will remain compatible with any other product or technology with which the product may be used.

How Long this Coverage Lasts

The standard limited warranty for Kramer products is seven (7) years from the date of original purchase, with the following exceptions:

1. All Kramer VIA hardware products are covered by a standard three (3) year warranty for the VIA hardware and a standard three (3) year warranty for firmware and software updates; all Kramer VIA accessories, adapters, tags, and dongles are covered by a standard one (1) year warranty.
2. All Kramer fiber optic cables, adapter-size fiber optic extenders, pluggable optical modules, active cables, cable retractors, all ring mounted adapters, all Kramer speakers and Kramer touch panels are covered by a standard one (1) year warranty.
3. All Kramer Cobra products, all Kramer Calibre products, all Kramer Minicom digital signage products, all HighSecLabs products, all streaming, and all wireless products are covered by a standard three (3) year warranty.
4. All Sierra Video MultiViewers are covered by a standard five (5) year warranty.
5. Sierra switchers & control panels are covered by a standard seven (7) year warranty (excluding power supplies and fans that are covered for three (3) years).
6. K-Touch software is covered by a standard one (1) year warranty for software updates.
7. All Kramer passive cables are covered by a ten (10) year warranty.

Who is Covered

Only the original purchaser of this product is covered under this limited warranty. This limited warranty is not transferable to subsequent purchasers or owners of this product.

What Kramer Electronics Will Do

Kramer Electronics will, at its sole option, provide one of the following three remedies to whatever extent it shall deem necessary to satisfy a proper claim under this limited warranty:

1. Elect to repair or facilitate the repair of any defective parts within a reasonable period of time, free of any charge for the necessary parts and labor to complete the repair and restore this product to its proper operating condition. Kramer Electronics will also pay the shipping costs necessary to return this product once the repair is complete.
2. Replace this product with a direct replacement or with a similar product deemed by Kramer Electronics to perform substantially the same function as the original product.
3. Issue a refund of the original purchase price less depreciation to be determined based on the age of the product at the time remedy is sought under this limited warranty.

What Kramer Electronics Will Not Do Under This Limited Warranty

If this product is returned to Kramer Electronics or the authorized dealer from which it was purchased or any other party authorized to repair Kramer Electronics products, this product must be insured during shipment, with the insurance and shipping charges prepaid by you. If this product is returned uninsured, you assume all risks of loss or damage during shipment. Kramer Electronics will not be responsible for any costs related to the removal or re-installation of this product from or into any installation. Kramer Electronics will not be responsible for any costs related to any setting up this product, any adjustment of user controls or any programming required for a specific installation of this product.

How to Obtain a Remedy Under This Limited Warranty

To obtain a remedy under this limited warranty, you must contact either the authorized Kramer Electronics reseller from whom you purchased this product or the Kramer Electronics office nearest you. For a list of authorized Kramer Electronics resellers and/or Kramer Electronics authorized service providers, visit our web site at www.kramerav.com or contact the Kramer Electronics office nearest you.

In order to pursue any remedy under this limited warranty, you must possess an original, dated receipt as proof of purchase from an authorized Kramer Electronics reseller. If this product is returned under this limited warranty, a return authorization number, obtained from Kramer Electronics, will be required (RMA number). You may also be directed to an authorized reseller or a person authorized by Kramer Electronics to repair the product.

If it is decided that this product should be returned directly to Kramer Electronics, this product should be properly packed, preferably in the original carton, for shipping. Cartons not bearing a return authorization number will be refused.

Limitation of Liability

THE MAXIMUM LIABILITY OF KRAMER ELECTRONICS UNDER THIS LIMITED WARRANTY SHALL NOT EXCEED THE ACTUAL PURCHASE PRICE PAID FOR THE PRODUCT. TO THE MAXIMUM EXTENT PERMITTED BY LAW, KRAMER ELECTRONICS IS NOT RESPONSIBLE FOR DIRECT, SPECIAL, INCIDENTAL OR CONSEQUENTIAL DAMAGES RESULTING FROM ANY BREACH OF WARRANTY OR CONDITION, OR UNDER ANY OTHER LEGAL THEORY. Some countries, districts or states do not allow the exclusion or limitation of relief, special, incidental, consequential or indirect damages, or the limitation of liability to specified amounts, so the above limitations or exclusions may not apply to you.

Exclusive Remedy

TO THE MAXIMUM EXTENT PERMITTED BY LAW, THIS LIMITED WARRANTY AND THE REMEDIES SET FORTH ABOVE ARE EXCLUSIVE AND IN LIEU OF ALL OTHER WARRANTIES, REMEDIES AND CONDITIONS, WHETHER ORAL OR WRITTEN, EXPRESS OR IMPLIED. TO THE MAXIMUM EXTENT PERMITTED BY LAW, KRAMER ELECTRONICS SPECIFICALLY DISCLAIMS ANY AND ALL IMPLIED WARRANTIES, INCLUDING, WITHOUT LIMITATION, WARRANTIES OF MERCHANTABILITY AND FITNESS FOR A PARTICULAR PURPOSE. IF KRAMER ELECTRONICS CANNOT LAWFULLY DISCLAIM OR EXCLUDE IMPLIED WARRANTIES UNDER APPLICABLE LAW, THEN ALL IMPLIED WARRANTIES COVERING THIS PRODUCT, INCLUDING WARRANTIES OF MERCHANTABILITY AND FITNESS FOR A PARTICULAR PURPOSE, SHALL APPLY TO THIS PRODUCT AS PROVIDED UNDER APPLICABLE LAW. IF ANY PRODUCT TO WHICH THIS LIMITED WARRANTY APPLIES IS A "CONSUMER PRODUCT" UNDER THE MAGNUSON-MOSS WARRANTY ACT (15 U.S.C.A. §2301, ET SEQ.) OR OTHER APPLICABLE LAW, THE FOREGOING DISCLAIMER OF IMPLIED WARRANTIES SHALL NOT APPLY TO YOU, AND ALL IMPLIED WARRANTIES ON THIS PRODUCT, INCLUDING WARRANTIES OF MERCHANTABILITY AND FITNESS FOR THE PARTICULAR PURPOSE, SHALL APPLY AS PROVIDED UNDER APPLICABLE LAW.

Other Conditions

This limited warranty gives you specific legal rights, and you may have other rights which vary from country to country or state to state.

This limited warranty is void if (i) the label bearing the serial number of this product has been removed or defaced, (ii) the product is not distributed by Kramer Electronics or (iii) this product is not purchased from an authorized Kramer Electronics reseller. If you are unsure whether a reseller is an authorized Kramer Electronics reseller, visit our web site at www.kramerav.com or contact a Kramer Electronics office from the list at the end of this document.

Your rights under this limited warranty are not diminished if you do not complete and return the product registration form or complete and submit the online product registration form. Kramer Electronics thanks you for purchasing a Kramer Electronics product. We hope it will give you years of satisfaction.



P/N:



2900-301237

Rev:



1



SAFETY WARNING

Disconnect the unit from the power supply before opening and servicing

For the latest information on our products and a list of Kramer distributors, visit our Web site where updates to this user manual may be found.

We welcome your questions, comments, and feedback.

The terms HDMI, HDMI High-Definition Multimedia Interface, and the HDMI Logo are trademarks or registered trademarks of HDMI Licensing Administrator, Inc. All brand names, product names, and trademarks are the property of their respective owners.