

Kramer Electronics, Ltd.

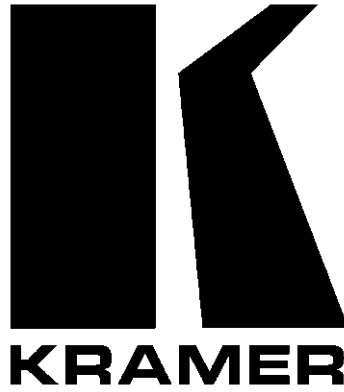

USER MANUAL

Model:

VA-2002

Multistandard Logo Generator

Contents

1	Introduction	1
2	Getting Started	1
2.1	Quick Start	1
3	Overview	3
4	Your VA-2002 Multistandard Logo Generator	3
5	Installing the VA-2002 on a Rack	6
6	Connecting the VA-2002 Multistandard Logo Generator	7
7	Installing the VA-2002 Software	9
8	Using the VA-2002 Logo Finalizer and Upload Program	12
8.1	Logo Graphics Characteristics and Limitations	13
8.2	Saving a Logo to a Floppy Disk	14
8.3	Adding Transparency to a Logo	17
8.4	Setting the Fade Speed	18
9	Using the VA-2002 Remote Control Program	19
9.1	Configuring the Remote Control Program	19
9.2	Controlling the VA-2002 from the Remote Control Program	21
9.2.1	Controlling Logos	21
9.2.2	Checking Information	21
9.3	Transferring a Logo via RS-232	21
10	Operating via the VA-2002 Front Panel	23
10.1	Identification and Status Screens	23
10.2	Accessing the Main Menu	24
10.2.1	Selecting a Logo from the Main Menu	24
10.2.2	Editing a Logo from the Main Menu	25
10.2.2.1	Loading a Logo from the Main Menu	25
10.2.2.2	Deleting a Logo from the Main Menu	26
10.2.2.3	Deleting all the Logos from the Main Menu	26
10.2.2.4	Reviewing Information about the Logo from the Main Menu	26
10.2.3	Checking System Information from the Main Menu	27
10.2.4	Setting the Preferences from the Main Menu	27
11	Technical Specifications	28

Figures

Figure 1: VA-2002 Multistandard Logo Generator	4
Figure 2: Connecting the VA-2002 Multistandard Logo Generator	8
Figure 3: VA-2002 Splash Screen	9
Figure 4: Welcome Window	9
Figure 5: Target Directory Window	10
Figure 6: Start Menu Window	10
Figure 7: Installation Window	11
Figure 8: Installation Complete	11
Figure 9: Bitmap Graphic Pixel limitations	13
Figure 10: Unnamed – VA-2000 Window	14
Figure 11: Selecting a Bitmap File	15
Figure 12: Solid Logo on the Upper Left Side of the Screen	15
Figure 13: Solid Logo on the Center Right Side of the Screen	16
Figure 14: Create Logo Disk Dialog Box	16
Figure 15: Transparent Logo on the Center Right Side of the Screen	17
Figure 16: Set Transparency Box	18
Figure 17: Select Fade Speed Box	18
Figure 18: VA-2002 Disconnected Remote Control Window	19
Figure 19: COM-Port Window	20
Figure 20: Active VA-2002 Remote Control Window	20
Figure 21: Selecting the Preferences via the VA-2002 Remote Control Window	20
Figure 22: Logo Info Window (Before RS-232 Transfer)	22
Figure 23: Selecting a Project File	22
Figure 24: Logo Info Window (After RS-232 Transfer)	23
Figure 25: Identification Screen	23
Figure 26: Status Screen	24
Figure 27: Main Menu (Select Logo) Screen	24
Figure 28: Select Logo Screen	24
Figure 29: Main Menu (Edit Logo) Screen	25
Figure 30: Edit Load Logo Screen	25

Tables

Table 1: Front Panel VA-2002 Multistandard Logo Generator Features	5
Table 2: Rear Panel VA-2002 Multistandard Logo Generator Features	5
Table 3: VA-2002 Logo Finalizer and Upload Program Toolbar Buttons	12
Table 4: Technical Specifications of the VA-2002 Multistandard Logo Generator	28

1 Introduction

Welcome to Kramer Electronics (since 1981): a world of unique, creative and affordable solutions to the infinite range of problems that confront the video, audio and presentation professional on a daily basis. In recent years, we have redesigned and upgraded most of our line, making the best even better! Our 500-plus different models now appear in 8 Groups¹, which are clearly defined by function.

Congratulations on purchasing your Kramer **VA-2002 Multistandard Logo Generator**, which is ideal for the following typical applications:

- Video broadcast studios for logo insertion in on-air broadcasting
- Video production facilities, for producer or client logo insertion
- Points of sale, shops, security, hospitals, universities, hotels, CCTV and other applications, which need source identification

The package includes the following items:

- **VA-2002 Multistandard Logo Generator**
- Power cord
- **VA-2002** CD-ROM that includes two Windows®-based programs—a Logo Finalizer and Upload program, and a Remote Control program—as well as a copy of this user manual
- This user manual²

2 Getting Started

We recommend that you:

- Unpack the equipment carefully and save the original box and packaging materials for possible future shipment
- Review the contents of this user manual
- Use Kramer high performance high resolution cables³

2.1 Quick Start

This quick start chart summarizes the basic setup and operation steps.

¹ GROUP 1: Distribution Amplifiers; GROUP 2: Video and Audio Switchers, Matrix Switchers and Controllers; GROUP 3: Video, Audio, VGA/XGA Processors; GROUP 4: Interfaces and Sync Processors; GROUP 5: Twisted Pair Interfaces; GROUP 6: Accessories and Rack Adapters; GROUP 7: Scan Converters and Scalers; and GROUP 8: Cables and Connectors

² Download up-to-date Kramer user manuals from our Web site at <http://www.kramerelectronics.com>

³ The complete list of Kramer cables is on our Web site at <http://www.kramerelectronics.com>

Step 1: Prepare the Bitmap - see section 5

Mount the machine in a rack or stick the 4 rubber feet to the underside

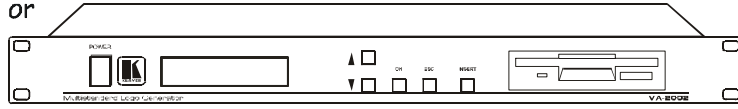

Step 2: Connect the inputs and outputs - see section 6

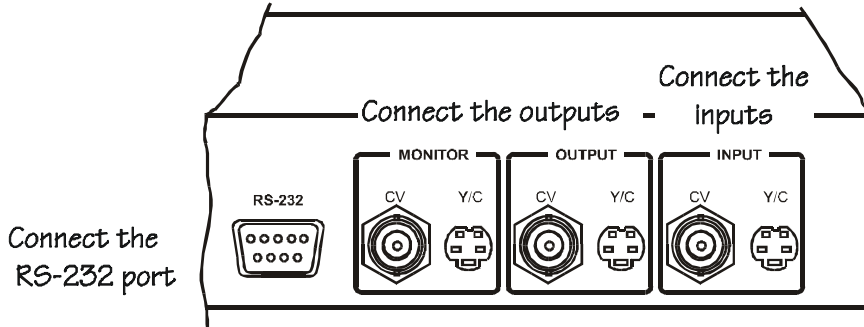

Step 3: From Bitmap to Logo - see sections 7 and 8

1
INSTALL THE SOFTWARE
See section 7

2
PREPARE THE BITMAP

The final computer-designed graphic must be a Bitmap

3
DEVELOP BITMAP INTO LOGO

Use the VA-2002 Logo Finalizer and Upload program to:

- Load the Bitmap file (see section 8.1)
- Set the position for the logo on-screen (see section 8.1)
- Set transparency - optional (see section 8.2)
- Set fade speed - optional (see section 8.3)
- Save a VA-2002 Project file (with the .LPJ extension) for transfer via RS-232 (optional when saving on a floppy disk)
- Create the logo.lgo file, saving it on a floppy disk (see section 8.1)

Step 4: Turn the power ON

Step 5: Transfer the Logo to the VA-2002

via RS-232
Transfer the logo via RS-232 (see section 9.3) using the VA-2002 Remote Control program

OR

via the floppy disk
Insert the floppy disk and load the logo via the VA-2002 Main Menu (see section 10.2.2.1)



Step 6: Insert the logo to the video signal

PRESS THE INSERT BUTTON TO DISPLAY THE LOGO

3 Overview

The **VA-2002 Multistandard Logo Generator** is a unique, high quality multi-standard (PAL and NTSC) color logo inserter for inserting a logo into a composite video and s-Video signal. Using the **VA-2002**, you can:

- Select a composite video or an s-Video (Y/C) input from the Preferences tab in the **VA-2002** Remote Control window, as well as from the Main Menu on the **VA-2002**
- Output simultaneously to both composite video and s-Video¹
- Preview a logo at a local composite video and/or s-Video monitor¹
- Store up to 9 logos simultaneously in non-volatile memory

In addition, the **VA-2002** includes:

- A menu-based control system, using a front panel LCD window, with push buttons for navigation and control
- An RS-232 port for logo selection, control and transfer to the **VA-2002**

Your **VA-2002** is computer-independent—you only need a computer to create² logos. You can transfer a logo to the **VA-2002** remotely via RS-232 or via a floppy disk.

To achieve the best performance:

- Connect only good quality connection cables, thus avoiding interference, deterioration in signal quality due to poor matching, and elevated noise-levels (often associated with low quality cables)
- Avoid interference from neighboring electrical appliances and position your Kramer **VA-2002** away from moisture, excessive sunlight and dust

4 Your VA-2002 Multistandard Logo Generator

Figure 1, Table 1, and Table 2 define the **VA-2002**:

¹ As the example in Figure 2 illustrates

² Via your computer-based drawing or graphics program

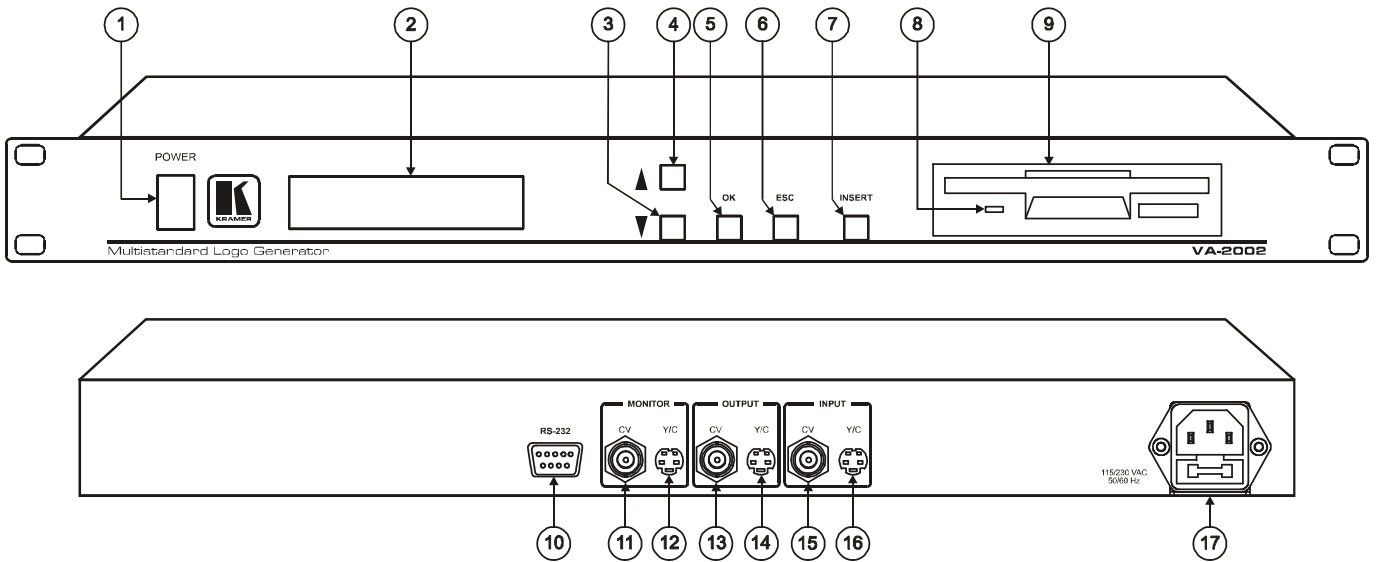

Figure 1: VA-2002 Multistandard Logo Generator

Table 1: Front Panel VA-2002 Multistandard Logo Generator Features

#	Feature	Function
1	POWER Switch	Illuminated switch for turning the unit ON or OFF
2	LCD Display Screen	Displays relevant data (default) or the Main Menu (when the OK button or the ESC button are pressed)
3	▲ Button	Moves up one step in the LCD display screen
4	▼ Button	Moves down one step in the LCD display screen
5	OK Button	Press to confirm a command
6	ESC Button	Press to stop the execution of a command
7	INSERT Button	Press to turn the logo On or Off ¹
8	Floppy Disk Drive Green LED	Lights when reading data from a floppy disk
9	Floppy Disk Drive	Insert a floppy disk in the floppy disk drive to transfer a logo

Table 2: Rear Panel VA-2002 Multistandard Logo Generator Features

#	Feature	Function	
10	RS-232 DB 9 Connector	Connects to PC or Serial Controller	
11	MONITOR	CVBNC Connector	Connects to the composite video monitor ²
12		Y/C 4p Connector	Connects to the s-Video monitor ²
13	OUTPUT	CVBNC Connector	Connects to the composite video acceptor
14		Y/C 4p Connector	Connects to the s-Video acceptor
15	INPUT	CVBNC Connector	Connects to the composite video source
16		Y/C 4p Connector	Connects to the s-Video source
17	Power Connector with FUSE	AC connector enabling power supply to the unit	

1 When displaying the logo, the INSERT button illuminates (after blinking momentarily)

2 When previewing a logo at a local monitor (composite video and/or s-Video), the logo only appears at these MONITOR outputs, and not at the OUTPUT connectors. You can set the MONITOR outputs to function as an additional pair of OUTPUT connectors (see section 9.1)

5 Installing the VA-2002 on a Rack

This section describes what to do before installing on a rack and how to rack mount.

Before Installing on a Rack

Before installing on a rack, be sure that the environment is within the recommended range:	
Operating temperature range	+5 to +45 Deg. Centigrade
Operating humidity range	5 to 65 % RHL, non-condensing
Storage temperature range	-20 to +70 Deg. Centigrade
Storage humidity range	5 to 95% RHL, non-condensing



CAUTION!!

When installing on a 19" rack, avoid hazards by taking care that:

- 1 It is located within the recommended environmental conditions, as the operating ambient temperature of a closed or multi unit rack assembly may exceed the room ambient temperature.
- 2 Once rack mounted, enough air will still flow around the machine.
- 3 The machine is placed straight in the correct horizontal position.
- 4 You do not overload the circuit(s). When connecting the machine to the supply circuit, overloading the circuits might have a detrimental effect on overcurrent protection and supply wiring. Refer to the appropriate nameplate ratings for information. For example, for fuse replacement, see the value printed on the product label.
- 5 The machine is earthed (grounded) in a reliable way and is connected only to an electricity socket with grounding. Pay particular attention to supply connections other than direct connections to the branch circuit (for example, the use of power strips), and that you use only the power cord that is supplied with the machine.

How to Rack Mount

To rack-mount the machine:

- 1 Attach both ear brackets to the machine. To do so, remove the screws from each side of the machine (3 on each side), and replace those screws through the ear brackets.

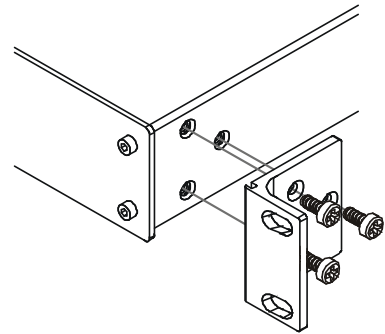

- 2 Place the ears of the machine against the rack rails, and insert the proper screws (not provided) through each of the four holes in the rack ears.

Note that:

- In some models, the front panel may feature built-in rack ears
- Detachable rack ears can be removed for desktop use
- Always mount the machine in the rack before you attach any cables or connect the machine to the power
- If you are using a Kramer rack adapter kit (for a machine that is not 19"), see the Rack Adapters user manual for installation instructions (you can download it at: <http://www.kramerelectronics.com>)

6 Connecting the VA-2002 Multistandard Logo Generator

To connect the **VA-2002 Multistandard Logo Generator** as the example in Figure 2 illustrates, do the following¹:

1. Connect a composite video source (for example, a composite video VCR) to the CV BNC INPUT connector.
2. Connect an s-Video source (for example, an s-Video S-VHS) to the Y/C 4p INPUT connector.
3. Connect the CV BNC OUTPUT connector to a composite video acceptor (for example, a composite video recorder).
4. Connect the Y/C 4p OUTPUT connector to an s-Video acceptor (for example, an s-Video projector).
5. Connect the CV BNC MONITOR connector to a composite video acceptor (for example, a display).
6. Connect the Y/C 4p MONITOR connector to an s-Video acceptor (for example, a display).
7. Connect the power cord (not shown in Figure 2).
8. If required, connect a PC² for use with the **VA-2002 Remote Control** program that lets you remotely transfer a logo to the **VA-2002** via RS-232, as well as control certain functions³ and verify information⁴, as section 9.1 describes.

1 Switch OFF the power on each device before connecting it to your VA-2002. After connecting your VA-2002, switch on its power and then switch on the power on each device

2 Use a flat-cable (that is, one-to-one uncrossed connections) without a null-modem adapter to connect the RS-232 DB9 port on your PC to the RS-232F DB9 rear panel port on the VA-2002

3 That is, turn a logo On or Off, as well as delete a logo or all the logos simultaneously

4 That is, memory, size, system information, and version number

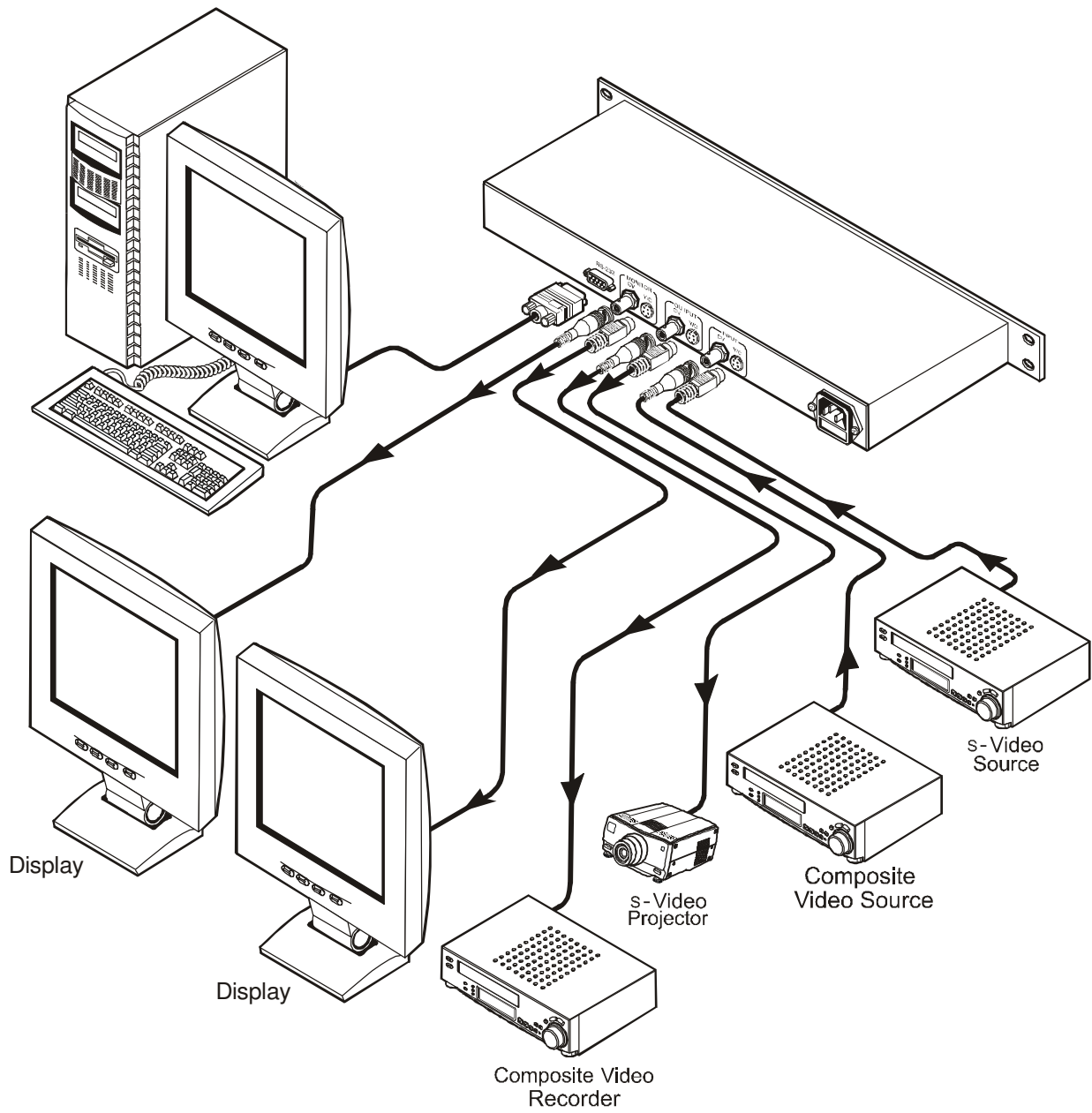

Figure 2: Connecting the VA-2002 Multistandard Logo Generator

7 Installing the VA-2002 Software

The VA-2002 CD-ROM includes two Windows®-based programs—a Logo Finalizer and Upload program¹, and a Remote Control program²—as well as a copy of this user manual.

To install³ the VA-2002 software:

1. Insert the VA-2002 CD-ROM in the CD-ROM drive.
The splash screen appears as follows:



Figure 3: VA-2002 Splash Screen

2. Click Install/Remove Software.
The Welcome window appears:

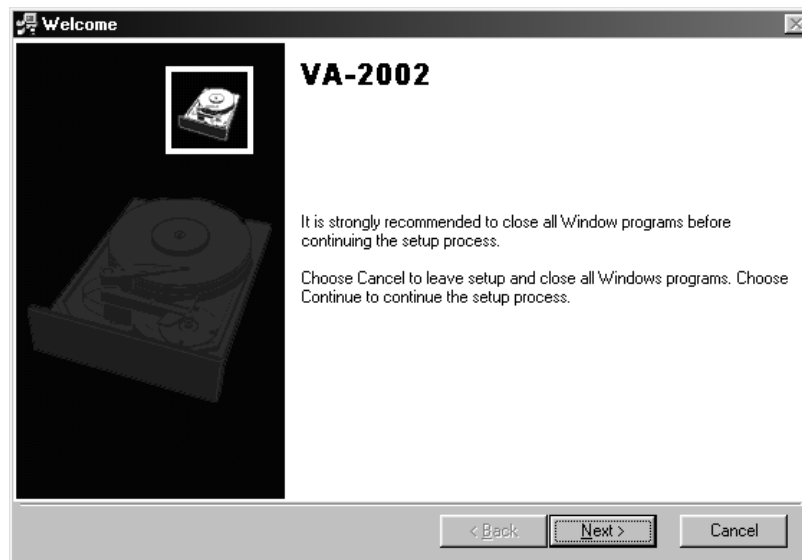

Figure 4: Welcome Window

¹ See section 8, for details

² See section 9, for details

³ To uninstall, click the VA-2002 Uninstall (located at C:\WINDOWS\Start Menu\Programs\VA-2002) and, at the warning prompt, confirm that you want to remove the programs

3. Click *Next*.

The *Target Directory* window appears (with “C:\Program Files\VA-2002\” selected as the default¹):

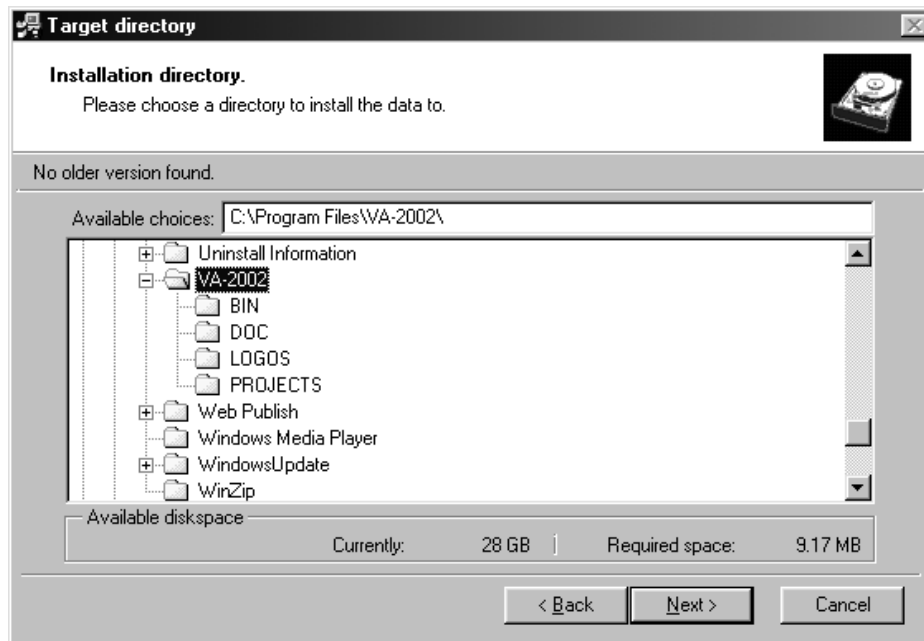

Figure 5: Target Directory Window

4. Click *Next*.

The *Start Menu* window appears, as Figure 6 illustrates:

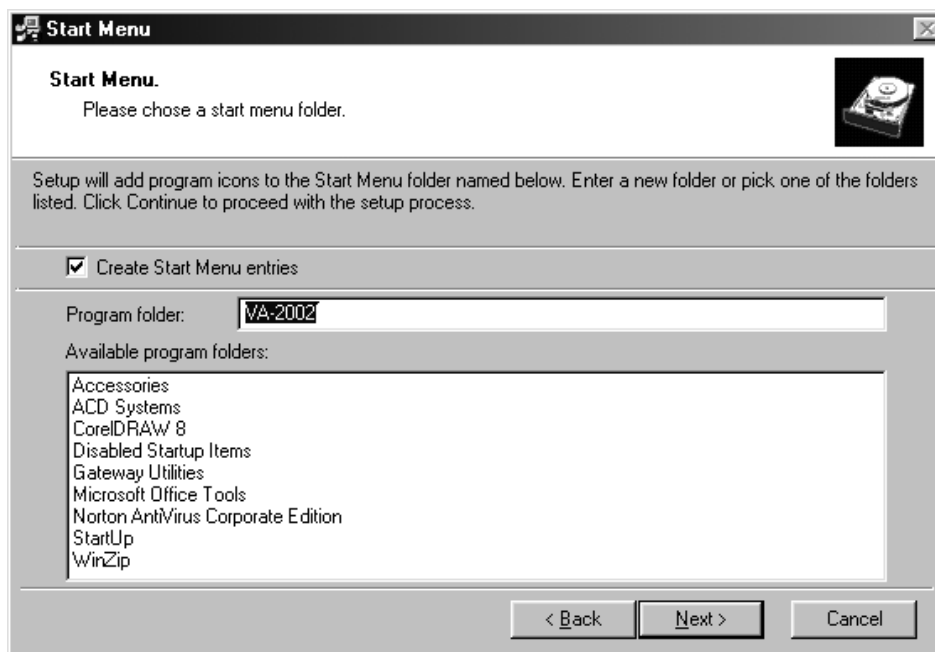

Figure 6: Start Menu Window

¹ You can choose a different location, instead of “C:\Program Files\VA-2002\”

5. Click *Next*.

The data is copied to your system, as Figure 7 illustrates and an installation complete window appears, as Figure 8 illustrates:

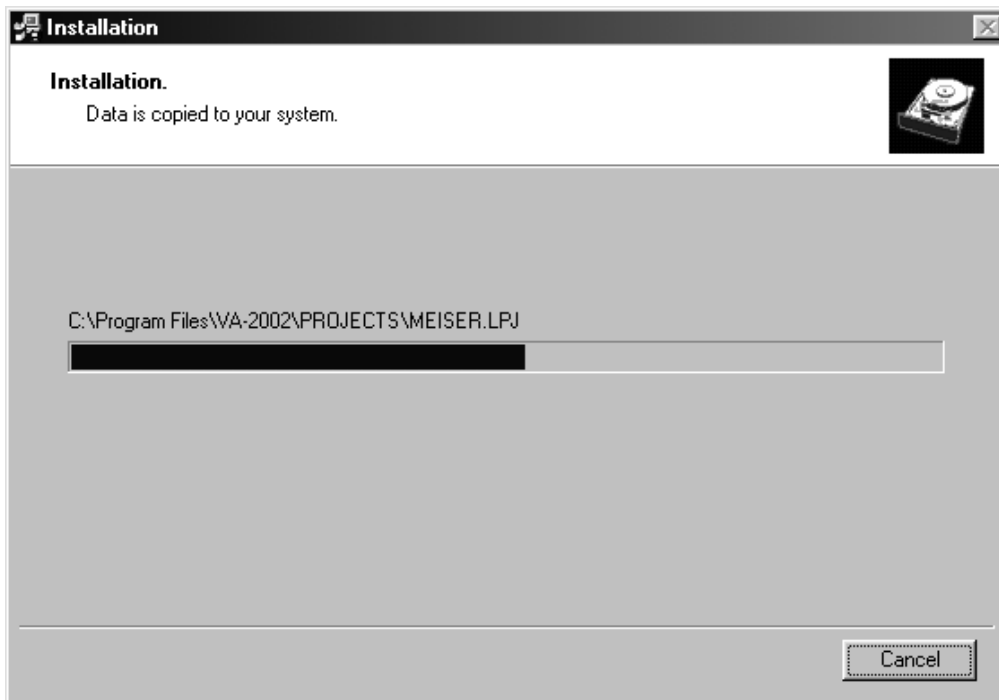

Figure 7: Installation Window



Figure 8: Installation Complete

6. Click *Finish*.

A shortcut appears in the Start Menu Programs folder.







8 Using the VA-2002 Logo Finalizer and Upload Program

You can use the **VA-2002** Logo Finalizer and Upload program to:

- Save a logo to a floppy disk (see section 8.2)
- Add transparency to a logo (see section 8.3)
- Set the Fade Speed (see section 8.4)

Table 3 defines the toolbar buttons:

Table 3: VA-2002 Logo Finalizer and Upload Program Toolbar Buttons

This button:	Has this functionality:
	Creates a new project
	Opens an existing project
	Saves the current project
	Displays the Create Logo Disk dialog box (see Figure 14)
	Zoom Buttons
	Displays the Set Transparency box (see Figure 16)

To transfer a logo via RS-232, see section 9.3.

8.1 Logo Graphics Characteristics and Limitations

The logo can only be derived from a graphic that is in bitmap file format¹, within the following limitations:

- The maximum total number of pixels in the graphic (width multiplied by height) should be 85,000 pixels
- You can set the width of the graphic to a maximum² of 686 pixels³
- You can set the height of the graphic to a maximum² of 576 pixels⁴
- The maximum size of the bitmap file should be 250KB
- The recommended color resolution should be 16 bit or better⁵

As long as the total value of pixels does not exceed 85,000 (see Figure 9), you can choose any width (up to 686 pixels) or any height (up to 576 pixels).

For example, if the width of the graphic is 360 pixels, the height should not exceed 236 pixels, since 360 multiplied by 236 equals 84,960 (almost the 85,000 limit). A width of 291 pixels and a height of 292 pixels is also applicable because when multiplied, the result does not exceed the 85,000 pixel limit. So, when choosing the width to be 686 pixels, you can set the height to be up to 123 pixels, for the same reason ($686 \times 123 = 84,378 < 85,000$).

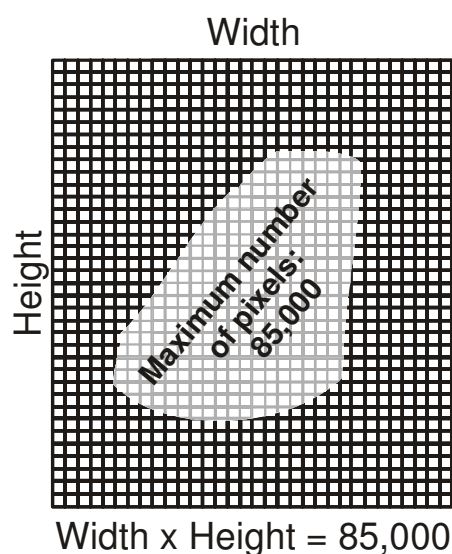

Figure 9: Bitmap Graphic Pixel limitations

¹ Convert a graphic that is in a non-bitmap format to a bitmap file, using a graphics program

² You cannot use a graphic which has the maximum width and the maximum height simultaneously because it would be more than 85,000 pixels

³ When set to the maximum width at 686 pixels, the height should be 123 pixels or less

⁴ When set to the maximum height at 576 pixels, the width should be 147 pixels or less

⁵ True color resolution (24 or 32 bit) is recommended

8.2 Saving a Logo to a Floppy Disk

You can use the **VA-2002** Logo Finalizer and Upload Program to save a logo on a floppy disk.

To save a logo to a floppy disk, do the following:

1. Start the **VA-2002** Logo Finalizer and Upload program by clicking the appropriate shortcut in the Start menu's Programs folder¹ or double-clicking the *VA2002_Finalizer.EXE* file².

The Unnamed – VA-2000 window opens displaying a background screen³, as Figure 10 illustrates:

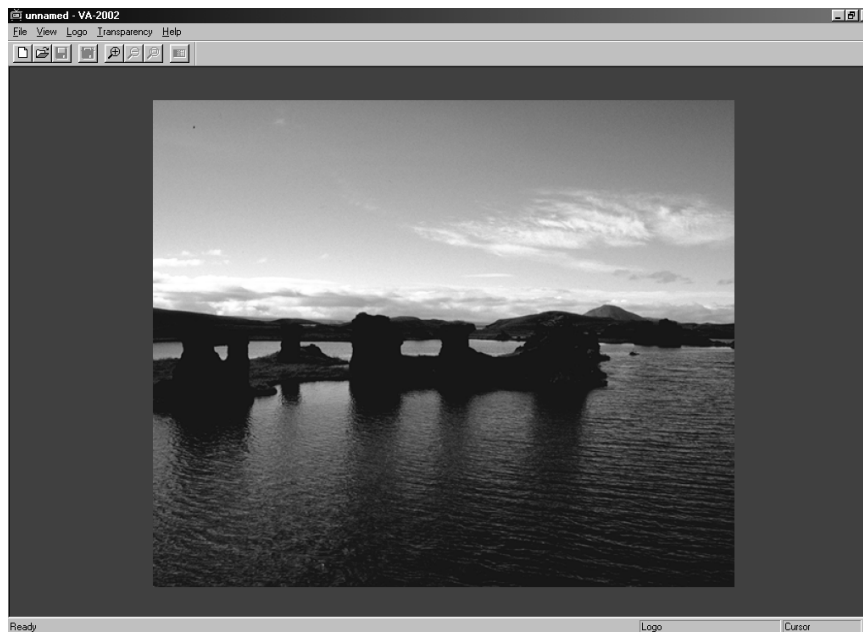

Figure 10: Unnamed – VA-2000 Window

2. From the Logo menu, click the Load command and choose a bitmap file⁴, as Figure 11 illustrates.

1 Located at C:\WINDOWS\Start Menu\Programs\VA-2002\VA2002 Finalizer

2 Located at C:\Program Files\VA-2002\Bin

3 This background screen is the default background screen (intended to emulate a television screen). However, you can select a different background screen or use your own (by placing a bitmap file in the C:\Program Files\VA-2002\Bin folder)

4 The VA-2002 Logo Finalizer and Upload Program includes several sample bitmap files that are suitable for use as logos

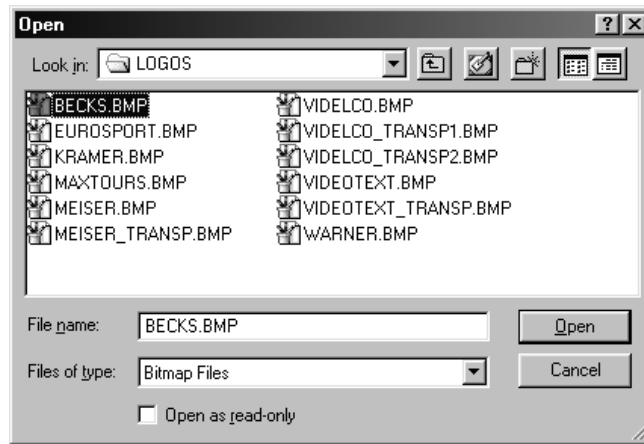

Figure 11: Selecting a Bitmap File

3. Click Open.
The Unnamed – VA-2000 window appears with the selected logo (in this example, Becks.bmp) superimposed on the upper left side, as Figure 12 illustrates.



Figure 12: Solid Logo on the Upper Left Side of the Screen

4. You can save the logo with the background screen as a **VA-2002** Project file¹, with the file name extension: **lpj** (optional when saving a logo to a floppy disk²).
5. You can move the bitmap to a different location on the screen—by dragging it with the mouse—as the example in Figure 13 illustrates.

1 For example, if the Unnamed – VA-2000 window (illustrated in Figure 10, Figure 12 and Figure 13) was saved as a VA-2002 Project file named “design”, the words “design.lpj” would appear in the Title bar

2 However, to transfer a logo via RS-232 (see section 9.3) that logo must be saved as part of a VA-2002 Project file

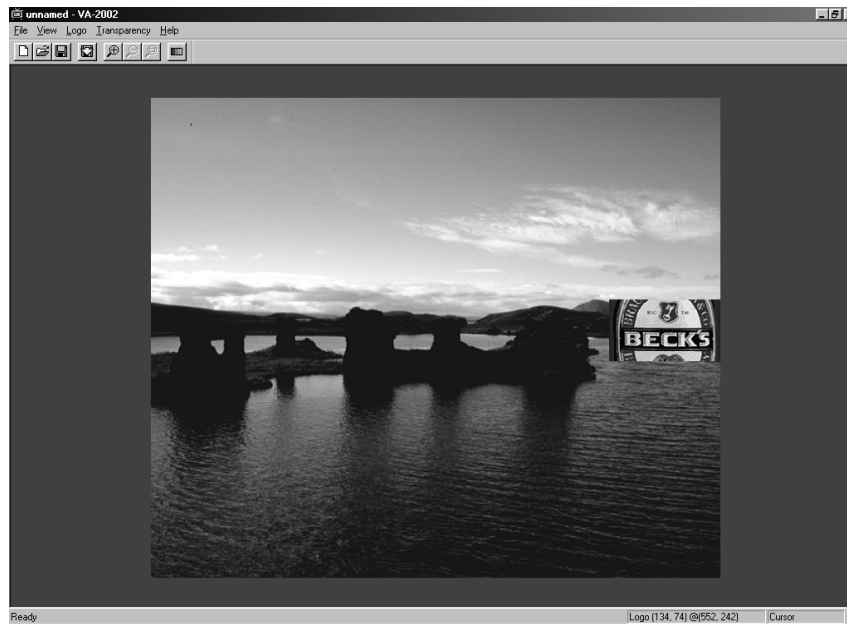

Figure 13: Solid Logo on the Center Right Side of the Screen

6. Add transparency to the logo (if required), as section 8.3 describes, and select the fade speed (if required), as section 8.4 describes.
7. From the File menu, select the CreateLogoDisk command. The Create Logo Disk dialog box appears, as Figure 14 illustrates:



Figure 14: Create Logo Disk Dialog Box

8. Overwrite the word “unnamed”¹ by typing a new name in its place (optional) and insert a floppy disk in the floppy disk drive on your computer and click Continue.

The logo is saved on the floppy disk with the file name: “logo.Igo”. Since a logo is always saved with the identical file name and file name extension, you can only save one logo on the same floppy disk at any time, otherwise saving an additional logo would replace the previous one.

9. Remove the floppy disk from the floppy disk drive on your computer and insert it in the floppy disk drive² on the **VA-2002**. Follow the instructions outlined in section 10.2.2.1 that describe how to load a logo.

8.3 Adding Transparency to a Logo

Add transparency to an inserted logo to enable the viewer to see what is being broadcast behind that logo. Generating a solid logo over part of the screen will block out that part of the viewing area. For example, compare the solid logo illustrated in Figure 13 with the transparent logo illustrated in Figure 15:

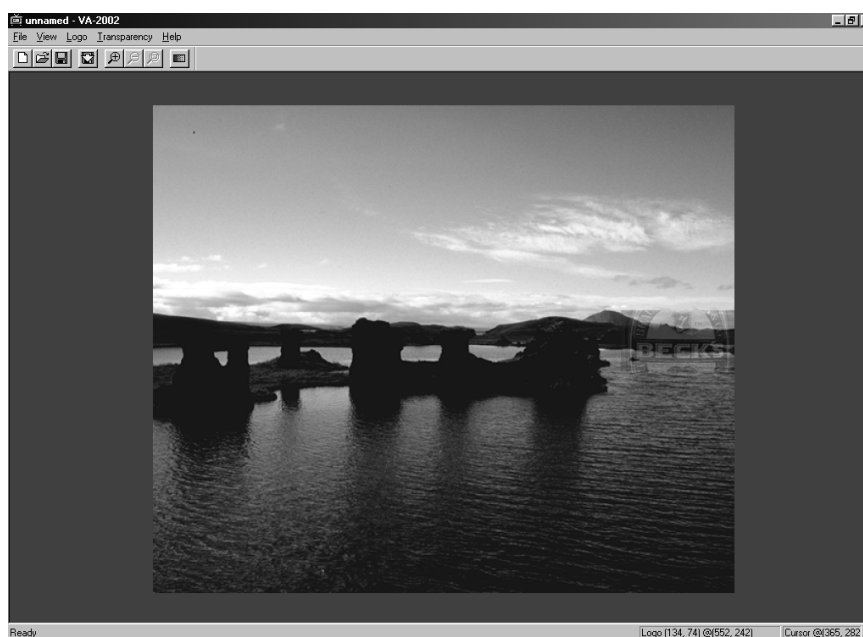

Figure 15: Transparent Logo on the Center Right Side of the Screen

To add transparency to a logo or part of a logo, already inserted, using the **VA-2002** Logo Finalizer and Upload program, do the following:

1. From the Transparency menu, select the Edit command.
The Set Transparency box appears, as Figure 16 illustrates:

1 The word “design” would appear automatically instead of “unnamed” if the Unnamed – VA-2000 window was saved as “design.lpj- VA-2000” (see step 4)

2 Item 9 on the front panel in Figure 1

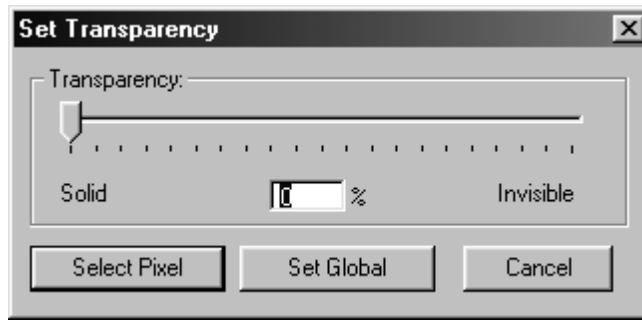

Figure 16: Set Transparency Box

2. Set the transparency level as required (between 0% for solid transparency¹ and up to 100% for invisible transparency²).
3. Adjust the logo's transparency by clicking one of the following:
 - “Set Global” to change the transparency of the whole logo, or
 - “Select Pixel” to change the transparency for parts of the logo with a certain color (zoom in and then choose the corresponding pixels with the mouse)

8.4 Setting the Fade Speed

Select the Fade Speed to set whether the logo will appear quickly or slowly.

To select the Fade Speed, using the **VA-2002** Logo Finalizer and Upload program, do the following:

1. From the Logo menu, select the Set Fadespeed command.
The Select Fade Speed box appears, as Figure 17 illustrates:

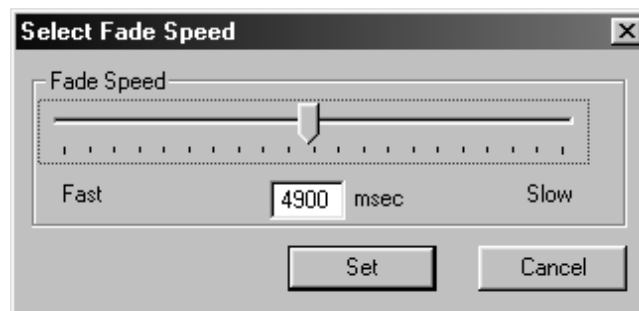

Figure 17: Select Fade Speed Box

2. Set the fade speed level as required (between 0 msec for the fastest fade speed, and up to 10000 msec for the slowest fade speed).

¹ As the example in Figure 13 illustrates

² In the example in Figure 15, transparency is set at 80%

9 Using the VA-2002 Remote Control Program

You can use the **VA-2002** Remote Control program to control your **VA-2002 Multistandard Logo Generator** from your PC via RS-232. The functionality of the **VA-2002** Remote Control program resembles the design of the Main Menu of the **VA-2002 Multistandard Logo Generator**.

After configuring the **VA-2002** Remote Control program on your PC¹ (see section 9.1), you can use it to control your **VA-2002 Multistandard Logo Generator** from your PC (see section 9.2), and to transfer a logo via RS-232 (see section 9.3).

9.1 Configuring the Remote Control Program

To configure the **VA-2002** Remote Control program to facilitate control of the **VA-2002 Multistandard Logo Generator** from your PC via RS-232, do the following:

1. Connect the RS-232 DB9 port on your PC to the RS-232F DB9 rear panel port² on the **VA-2002**, using a flat-cable³. **Do not use a null-modem adapter.**
2. Start the **VA-2002** Remote Control program by clicking the appropriate shortcut in the Start menu's Programs folder⁴ or double-clicking the *VA2002_Remote.EXE*⁵ file.

The **VA-2002** (disconnected) Remote Control window opens in the Status tab, when starting the program for the first time⁶.



Figure 18: VA-2002 Disconnected Remote Control Window

1 Configuration changes made via your PC are immediately visible on the VA-2002 Multistandard Logo Generator, and vice versa

2 Item 1 on the rear panel in Figure 1

3 Make one-to-one connections (that is, uncrossed)

4 Located at C:\WINDOWS\Start Menu\Programs\VA-2002\VA2002 Remote

5 Located at C:\Program Files\VA-2002\Bin

6 When you subsequently use the program, the active VA-2002 Remote Control window will open

3. Click Configure and then select an active serial port (COM 1 - COM 4) from the COM-Port window that opens adjacent to the Remote Control window, as Figure 19 illustrates:



Figure 19: COM-Port Window

4. Click Close to activate the VA-2002 Remote Control window, as Figure 20 illustrates:

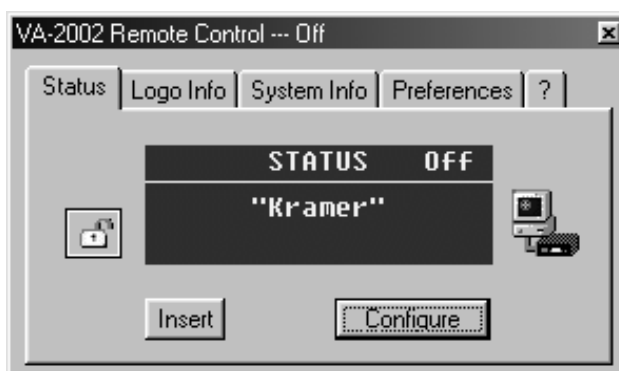

Figure 20: Active VA-2002 Remote Control Window

5. Click the Preferences tab¹ to select the input source (composite video or s-Video) and the video standard (PAL or NTSC), as Figure 21 illustrates. In addition, you can set the MONITOR outputs to function as an additional pair of OUTPUT connectors.

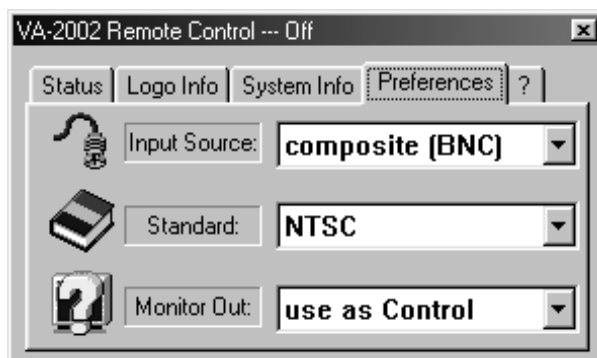

Figure 21: Selecting the Preferences via the VA-2002 Remote Control Window

¹ The Preferences tab functionality resembles the design of the Main Menu of the VA-2002

9.2 Controlling the VA-2002 from the Remote Control Program

You can control (that is, display, hide or delete) a logo and check relevant information, as sections 9.2.1 and 9.2.2 describe, respectively.

9.2.1 Controlling Logos

You can use the **VA-2002** Remote Control program, to do the following:

- Turn a logo On or Off (by clicking the Insert¹ button on the Status tab and/or on the Logo Info tab)
- Delete a logo that is installed in the non-volatile memory of the **VA-2002** (by clicking the Delete button on the Logo Info tab)
- Delete all the logos simultaneously that are installed in the non-volatile memory of the **VA-2002** (by clicking the Del. All button on the Logo Info tab)

9.2.2 Checking Information

You can use the **VA-2002** Remote Control program to check:

- Information about the logo, such as the size or memory (by clicking the Info button on the Logo Info tab)
- System information, such as the total memory available and the memory currently used² (by clicking the System Info tab)

9.3 Transferring a Logo via RS-232

You can use the **VA-2002** Remote Control program to transfer a logo via RS-232—instead of saving it on a floppy disk (as section 8.2 describes) and then inserting that floppy disk in the floppy disk drive of the **VA-2002**—but transfer via RS-232 requires that the logo be saved as part of a VA-2002 Project file.

To transfer a logo via RS-232, using the **VA-2002** Remote Control program, do the following:

1. Click the Logo Info tab, as Figure 22 illustrates:

¹ Which has the same functionality as the INSERT button on the VA-2002 front panel (item 7 in Figure 1)

² As well as verifying the operating system (for example, ver. 2.0) and the serial number

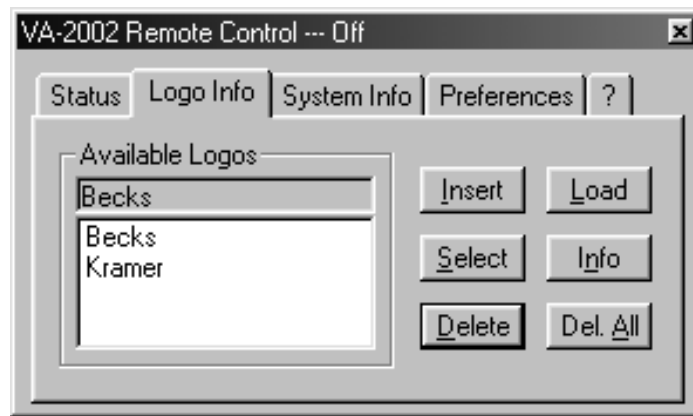

Figure 22: Logo Info Window (Before RS-232 Transfer)

2. Click the Load button and then choose a VA-2002 Project file, as Figure 23 illustrates:

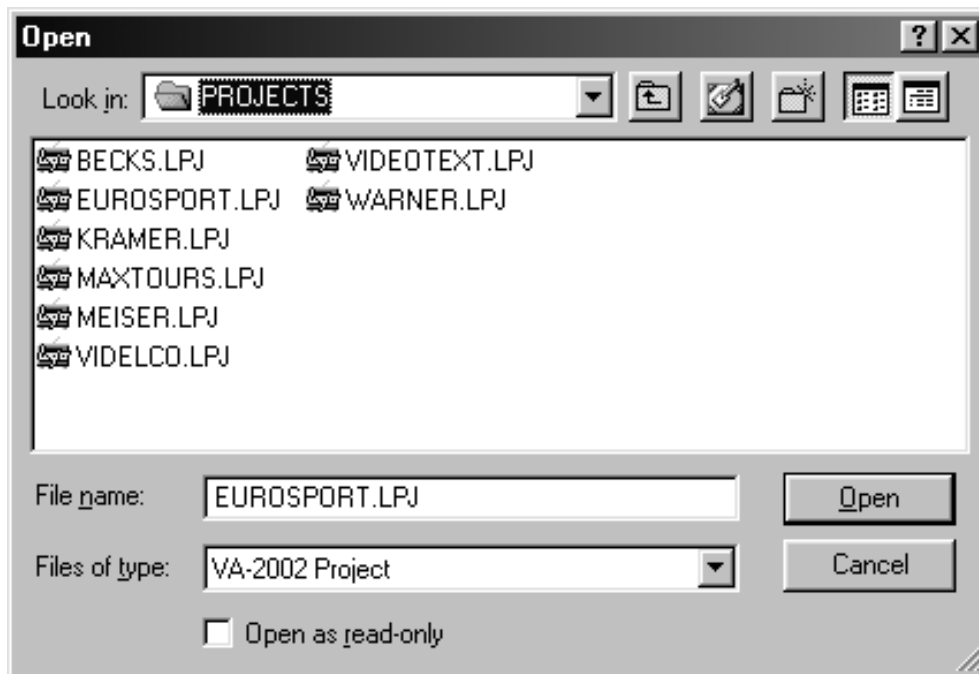

Figure 23: Selecting a Project File

3. Click open.
Progress bar messages appear simultaneously on both your PC monitor¹ and on the LCD Display screen² on the front panel³ of the **VA-2002 Multistandard Logo Generator**.
The logo is transferred to the non-volatile memory of the **VA-2002 Multistandard Logo Generator**.

1 The message “Sending Logo...” is displayed

2 The message “LOAD LOGO...” is displayed

3 Item 2 in Figure 1

The name of the transferred logo appears in the Available Logos list in the Logo Info tab, as Figure 24 illustrates:

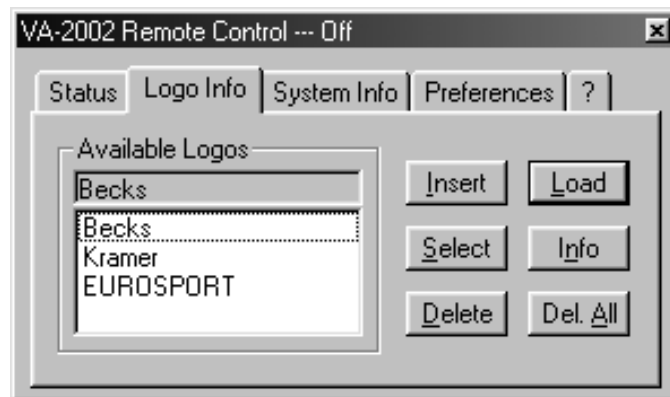

Figure 24: Logo Info Window (After RS-232 Transfer)

10 Operating via the VA-2002 Front Panel

You can operate¹ the **VA-2002** via the following front panel buttons:

- An INSERT button to turn the logo On or Off
- An ESC button to stop the execution of a command
- An OK button to confirm a command
- UP and DOWN buttons for moving up or down one step in the Main Menu

10.1 Identification and Status Screens

After turning on the power on the **VA-2002**, the identification screen appears momentarily, as follows:

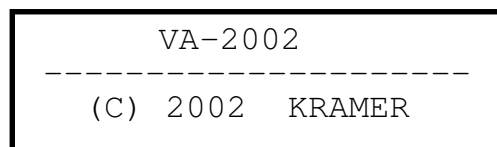

Figure 25: Identification Screen

¹ To control logos (see section 9.2.1), check information (see section 9.2.2), as well as loading a logo from a floppy disk (see section 10.2.2.1)

After a few seconds the Status Screen appears, indicating whether the logo is switched On or Off¹, the name of the logo, and if a video signal is present².

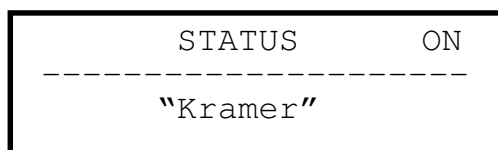

Figure 26: Status Screen

10.2 Accessing the Main Menu

From the Main Menu, you can³:

- Select a logo (see section 10.2.1)
- Edit a logo (see section 10.2.2)
- Check the System Information (see section 10.2.3)
- Set the Preferences (see section 10.2.4)

10.2.1 Selecting a Logo from the Main Menu

To select a logo from the Main Menu:

1. Press the OK button or the ESC button.
The Main Menu appears, as Figure 27 illustrates.

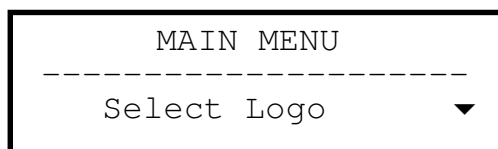

Figure 27: Main Menu (Select Logo) Screen

2. Press the OK button.
The name of the currently selected logo appears with an asterisk before it, as Figure 28 illustrates.

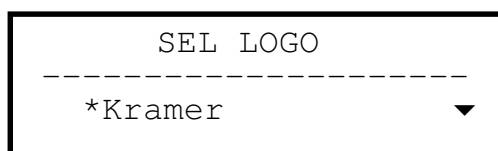

Figure 28: Select Logo Screen

1 Press the INSERT button to toggle between logo On and logo Off

2 When no video signal is present, the message * no input signal! * appears alternately with the name of the logo

3 Press the ESC button to return to the Main Menu at any time

3. Press the UP and DOWN buttons (if required) to select the desired logo and then press the OK button.

A message appears momentarily confirming that the new settings are saved, and then the Main Menu appears, as illustrated in Figure 27.

10.2.2 Editing a Logo from the Main Menu

From the Edit Logo Main Menu, you can:

- Load a logo (see section 10.2.2.1)
- Delete a logo (see section 10.2.2.2)
- Delete all logos (see section 10.2.2.3)
- Review information about size and memory (see section 10.2.2.4)

10.2.2.1 Loading a Logo from the Main Menu

To load a logo (that is, transfer a new logo from a floppy disk):

1. Press the OK button or the ESC button.
The Main Menu appears, as Figure 27 illustrates.
2. Press the DOWN button once.
The Main Menu Edit logo screen appears, as Figure 29 illustrates:

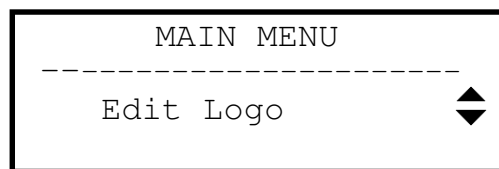

Figure 29: Main Menu (Edit Logo) Screen

3. Press the OK button.
The Edit Load logo screen appears, as Figure 30 illustrates:



Figure 30: Edit Load Logo Screen

4. Insert the floppy disk in the floppy drive and press the OK button.
The logo is copied from the floppy disk to the non-volatile memory of the VA-2002, and the floppy drive LED¹ lights momentarily.

¹ Item 8 on the front panel in Figure 1

Note that if the logo is already stored in the non-volatile memory of the **VA-2002**, a message will appear¹ offering to let you replace it.

If the logo is On (and the INSERT button illuminates) a message will appear² prompting you to turn the logo Off (by pressing the INSERT button).

10.2.2.2 Deleting a Logo from the Main Menu

To delete a logo:

1. Press the OK button or the ESC button.
The Main Menu appears, as Figure 27 illustrates.
2. Press the DOWN button.
The Main Menu Edit logo screen appears, as Figure 29 illustrates:
3. Press the OK button.
The Edit Load logo screen appears, as Figure 30 illustrates:
4. Press the DOWN button twice.
The Edit Delete logo screen appears.
5. Press the OK button and select the logo for deletion using the UP and DOWN buttons.
6. Press the OK button and confirm the deletion (choosing Yes) using the UP and DOWN buttons.
The logo is deleted.

10.2.2.3 Deleting all the Logos from the Main Menu

To delete all the logos simultaneously:

1. Follow steps 1 to 3, as outlined in section 10.2.2.2.
2. Press the DOWN button 3 times.
The Edit Delete all logos screen appears.
3. Press the OK button and confirm the deletion (choosing Yes) using the UP and DOWN buttons.
All the logos are deleted.

10.2.2.4 Reviewing Information about the Logo from the Main Menu

To review information about the size and memory of the logo:

1. Follow steps 1 to 3 as outlined in section 10.2.2.2.
2. Press the DOWN button.
The Edit Info screen appears.

¹ As follows: "Logo exists! Replace? Yes or No"

² As follows: "Please switch off the logo to continue"

3. Press the OK button.
Information about the current logo appears – its name, size, and memory.
To review information about a different logo, select that logo using the UP and DOWN buttons.

10.2.3 Checking System Information from the Main Menu

From the System Info Main Menu, you can verify the **VA-2002** settings.

To check system info from the Main Menu:

1. Press the OK button or the ESC button.
The Main Menu appears, as Figure 27 illustrates.
2. Press the DOWN button twice.
The System Info Main Menu screen appears.
3. Press the OK button.
The System Info serial number screen appears.
4. Press the UP and DOWN buttons to access the screen with the system information that you require¹.

The system information screens display in the following order:

- Serial number
- Operating system
- Number of logos stored in the non-volatile memory
- Total memory available
- (Currently) Used memory
- Input source (composite video or s-Video)
- (Video) Standard (PAL or NTSC)
- Monitor out (control or monitor)
- Front panel lock (On or Off)

10.2.4 Setting the Preferences from the Main Menu

To set the Preferences from the Main Menu:

1. Press the OK button or the ESC button.
The Main Menu appears, as Figure 27 illustrates.
2. Press the DOWN button 3 times.
The Preferences Main Menu screen appears.
3. Press the OK button.
The Preferences Video Input Signal screen appears.

¹ Press the ESC button to return to the Main Menu at any time

4. Press the UP and DOWN buttons to access the specific Preferences screen that you require.

The screens that display the Preferences appear in the following order:

- Video input source (select composite video or s-Video)
- Video standard (select PAL or NTSC)
- Monitor Out Configuration (select to use as control, or to use as monitor)
- Lock¹ (to lock the front panel, press the OK button twice; to unlock the front panel, simultaneously press both the UP and DOWN buttons)
- Upload Software¹ (to download an upgrade to Flash memory, insert the floppy disk with the new operating system in the floppy disk drive² and press the OK button. Press the DOWN button and then the OK button again (choosing Yes))

11 Technical Specifications

Table 4 includes the technical specifications:

Table 4: Technical Specifications³ of the VA-2002 Multistandard Logo Generator

INPUTS:	1 CV, 1Vpp/75Ω 1 YC, "Y"=1Vpp/75Ω, "C"=0.3Vpp/75Ω
OUTPUTS:	2 of each: CV, 1Vpp/75Ω and YC, "Y"=1Vpp/75Ω, "C"=0.3Vpp/75Ω
MAX. OUTPUT LEVEL:	1 Vpp/75Ω CV or "Y"
BANDWIDTH (-3dB):	5.5 MHz, CV or "Y"
DIFF. GAIN:	<2.7%
DIFF. PHASE:	<0.6 deg.
K-FACTOR:	<1.5%
S/N RATIO:	63dB
CONTROLS:	5 front panel buttons, RS-232
COUPLING:	AC
POWER SOURCE:	100-230 VAC, 50/60 Hz, 12VA max.
DIMENSIONS:	19-inch (W), 8.6-inch (D) 1U (H) rack-mountable
WEIGHT:	3.2 kg. (7.1 lbs.)
ACCESSORIES:	Power cord

¹ Only available from the front panel, and not from the Preferences tab of the VA-2002 Remote Control Window

² Item 9 on the front panel in Figure 1

³ Specifications are subject to change without notice

LIMITED WARRANTY

Kramer Electronics (hereafter *Kramer*) warrants this product free from defects in material and workmanship under the following terms.

HOW LONG IS THE WARRANTY

Labor and parts are warranted for seven years from the date of the first customer purchase.

WHO IS PROTECTED?

Only the first purchase customer may enforce this warranty.

WHAT IS COVERED AND WHAT IS NOT COVERED

Except as below, this warranty covers all defects in material or workmanship in this product. The following are not covered by the warranty:

1. Any product which is not distributed by Kramer, or which is not purchased from an authorized Kramer dealer. If you are uncertain as to whether a dealer is authorized, please contact Kramer at one of the agents listed in the web site www.kramerelectronics.com.
2. Any product, on which the serial number has been defaced, modified or removed.
3. Damage, deterioration or malfunction resulting from:
 - i) Accident, misuse, abuse, neglect, fire, water, lightning or other acts of nature
 - ii) Product modification, or failure to follow instructions supplied with the product
 - iii) Repair or attempted repair by anyone not authorized by Kramer
 - iv) Any shipment of the product (claims must be presented to the carrier)
 - v) Removal or installation of the product
 - vi) Any other cause, which does not relate to a product defect
 - vii) Cartons, equipment enclosures, cables or accessories used in conjunction with the product

WHAT WE WILL PAY FOR AND WHAT WE WILL NOT PAY FOR

We will pay labor and material expenses for covered items. We will not pay for the following:

1. Removal or installations charges.
2. Costs of initial technical adjustments (set-up), including adjustment of user controls or programming. These costs are the responsibility of the Kramer dealer from whom the product was purchased.
3. Shipping charges.

HOW YOU CAN GET WARRANTY SERVICE

1. To obtain service on your product, you must take or ship it prepaid to any authorized Kramer service center.
2. Whenever warranty service is required, the original dated invoice (or a copy) must be presented as proof of warranty coverage, and should be included in any shipment of the product. Please also include in any mailing a contact name, company, address, and a description of the problem(s).
3. For the name of the nearest Kramer authorized service center, consult your authorized dealer.

LIMITATION OF IMPLIED WARRANTIES

All implied warranties, including warranties of merchantability and fitness for a particular purpose, are limited in duration to the length of this warranty.

EXCLUSION OF DAMAGES

The liability of Kramer for any effective products is limited to the repair or replacement of the product at our option. Kramer shall not be liable for:

1. Damage to other property caused by defects in this product, damages based upon inconvenience, loss of use of the product, loss of time, commercial loss; or:
2. Any other damages, whether incidental, consequential or otherwise. Some countries may not allow limitations on how long an implied warranty lasts and/or do not allow the exclusion or limitation of incidental or consequential damages, so the above limitations and exclusions may not apply to you.

This warranty gives you specific legal rights, and you may also have other rights, which vary from place to place.

NOTE: All products returned to Kramer for service must have prior approval. This may be obtained from your dealer.

This equipment has been tested to determine compliance with the requirements of:

- EN-50081: "Electromagnetic compatibility (EMC);
generic emission standard.
Part 1: Residential, commercial and light industry"
- EN-50082: "Electromagnetic compatibility (EMC) generic immunity standard.
Part 1: Residential, commercial and light industry environment".
- CFR-47: FCC Rules and Regulations:
Part 15: "Radio frequency devices
Subpart B – Unintentional radiators"

CAUTION!

- ☒ Servicing the machines can only be done by an authorized Kramer technician. Any user who makes changes or modifications to the unit without the expressed approval of the manufacturer will void user authority to operate the equipment.
- ☒ Use the supplied DC power supply to feed power to the machine.
- ☒ Please use recommended interconnection cables to connect the machine to other components.



For the latest information on our products and a list of Kramer distributors, visit our Web site: www.kramerelectronics.com, where updates to this user manual may be found. We welcome your questions, comments and feedback.



Caution

Safety Warning:

Disconnect the unit from the power supply before opening/servicing.



Kramer Electronics, Ltd.

Web site: www.kramerelectronics.com

E-mail: info@kramerel.com

P/N: 2900-006017 REV 4