



KRAMER ELECTRONICS LTD.

USER MANUAL

MODEL:

VS-5x5

5x5 Video Audio Matrix
Switcher

P/N: 2900-055001 Rev 6

VS-5x5 Quick Start Guide

This page guides you through a basic installation and first-time use of your **VS-5x5**. For more detailed information, see the **VS-5x5** User Manual. You can download the latest manual at <http://www.kramerelectronics.com>.

Step 1: Check what's in the box

- The **VS-5x5** Matrix Switcher
 - Kramer **RC-IR3** Infrared Remote Control Transmitter (with battery and user manual)
 - 1 Power cord
- 1 Quick Start sheet
 - 1 User Manual
 - 1 Set of rack "ears"
 - 4 Rubber feet

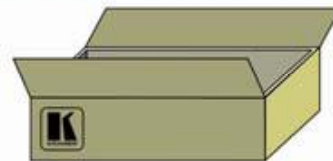

Save the original box and packaging materials in case your Kramer product needs to be returned to the factory for service.

Step 2: Install the VS-5x5

Mount the machine in a rack using the included rack "ears" or place on a table.

Step 3: Connect the inputs and outputs

Always switch off the power on each device before connecting it to your **VS-5x5**.

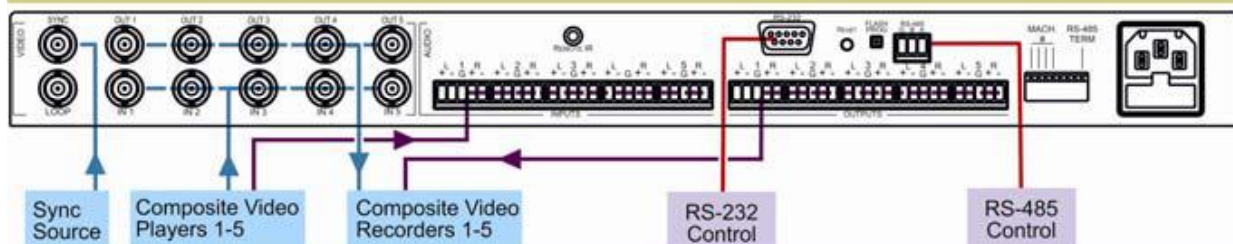

For best results, we recommend that you always use Kramer high-performance cables to connect AV equipment to the **VS-5x5**.

Step 4: Connect the power

Connect AC power to the rear of the **VS-5x5**, switch on its power and then switch on the power on each device.



Step 5: Operate the VS-5x5

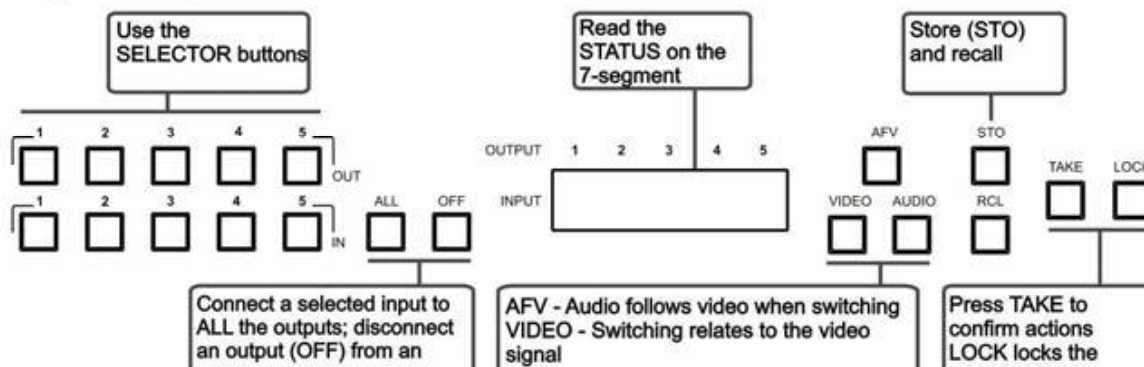

Set the machine address and termination when using a serial controller or daisy-chained units

Contents

1	Introduction	1
2	Getting Started	2
2.1	Achieving the Best Performance	2
2.2	Firmware Upgrade	2
3	Overview	3
3.1	Defining the VS-5x5 5x5 Video Audio Matrix Switcher	3
4	Installing in a Rack	6
5	Connecting the VS-5x5 5x5 Video Audio Matrix Switcher	7
5.1	Connecting the VS-5x5 Rear Panel	7
5.2	Connecting to the VS-5x5 via RS-232	8
5.3	Connecting a PC or Controller to the RS-485 Port	9
5.4	Connecting a Balanced/Unbalanced Stereo Audio Input/Output	10
5.5	Setting the DIP-Switches	10
6	Controlling via RS-232 and RS-485	12
7	Operating the VS-5x5	14
7.1	Displaying Unit Characteristics	14
7.2	Choosing the Audio-Follow-Video or Breakaway Option	15
7.3	Switching OUT-IN Combinations	15
7.4	Confirming Settings	16
7.5	Storing/Recalling Input/Output Configurations	17
7.6	Locking the Front Panel	19
7.7	Adjusting the Audio Gain Control	19
8	Technical Specifications	20
9	Table of Hex Codes for Serial Communication	21
10	Tables of Hex Codes for Audio Input/Output Gain Control	22
10.1	Tables of Hex Codes for Audio Input Gain Control	22
10.2	Tables of Hex Codes for Audio Output Gain Control	24
11	Kramer Protocol 2000	26

Figures

Figure 1:	VS-5x5 Video Audio Matrix Switcher - Front Panel	4
Figure 2:	VS-5x5 Video Audio Matrix Switcher - Rear Panel	5
Figure 3:	Connecting the VS-5x5 5x5 Video Audio Matrix Switcher	8
Figure 4:	Crossed Cable RS-232 Connection	9
Figure 5:	Straight Cable RS-232 Connection with a Null Modem Adapter	9
Figure 6:	Balanced Stereo Audio Connection	10
Figure 7:	Unbalanced Stereo Audio Input Connection	10
Figure 8:	Unbalanced Stereo Audio Output Connection	10
Figure 9:	DIP-switch Settings	10
Figure 10:	Cascade Configuration for RS-232/RS-485 Control	13
Figure 11:	VS-5x5 Unit Characteristics	14
Figure 12:	Storing and Recalling using the Input / Output Buttons	17

1 Introduction

Welcome to Kramer Electronics! Since 1981, Kramer Electronics has been providing a world of unique, creative, and affordable solutions to the vast range of problems that confront the video, audio, presentation, and broadcasting professional on a daily basis. In recent years, we have redesigned and upgraded most of our line, making the best even better!

Our 1,000-plus different models now appear in 11 groups that are clearly defined by function: GROUP 1: Distribution Amplifiers; GROUP 2: Switchers and Matrix Switchers; GROUP 3: Control Systems; GROUP 4: Format/Standards Converters; GROUP 5: Range Extenders and Repeaters; GROUP 6: Specialty AV Products; GROUP 7: Scan Converters and Scalers; GROUP 8: Cables and Connectors; GROUP 9: Room Connectivity; GROUP 10: Accessories and Rack Adapters; and GROUP 11: Sierra Products.

Congratulations on purchasing your Kramer **VS-5x5** *5x5 Video Audio Matrix Switcher*, which is ideal for the following typical applications:

- Professional display systems requiring true 5x5 matrix operation
- Multimedia and presentation source and acceptor selection, and remote monitoring of computer activity in schools and businesses

2 Getting Started

We recommend that you:

- Unpack the equipment carefully and save the original box and packaging materials for possible future shipment
- Review the contents of this user manual
- Use Kramer high performance high resolution cables
- Use only the power cord that is supplied with this machine



Go to <http://www.kramerelectronics.com> to check for up-to-date user manuals, application programs, and to check if firmware upgrades are available (where appropriate).

2.1 Achieving the Best Performance

To achieve the best performance:

- Use only good quality connection cables to avoid interference, deterioration in signal quality due to poor matching, and elevated noise levels (often associated with low quality cables)
- Avoid interference from neighboring electrical appliances that may adversely influence signal quality
- Position your Kramer **VS-5x5** away from moisture, excessive sunlight and dust

2.2 Firmware Upgrade

For instructions on upgrading the firmware, see the document: *Upgrading the VS-5x5 Firmware*.

The latest version of firmware and installation instructions can be downloaded from the Kramer Web site at www.kramerelectronics.com.

3 Overview

The **VS-5x5** is a true 5x5 matrix switcher for composite video signals and balanced stereo audio signals. The **VS-5x5** lets you simultaneously route any or all of the 5 inputs to any or all of the 5 outputs.

The **VS-5x5 5x5 Video Audio Matrix Switcher** includes:

- Video bandwidth of 70MHz that ensures transparent performance
- Easy-to-connect detachable terminal block connectors for the audio signals
- Glitch-free transitions, which are produced when sources share a common reference sync, as switching occurs during the vertical interval. Any input or special external sync input may be selected as the vertical interval source
- DC coupled inputs and outputs
- Audio-follow-video and breakaway options
- The storing and recalling of setups
- A “Take” button for precise switch control
- A “Lock” button to prevent tampering with the front panel
- Gain control for all inputs and all outputs

Control the **VS-5x5** via:

- The front panel buttons, infrared remote control transmitter, and remotely by RS-485 or RS-232 serial commands transmitted by a touch screen system, PC, RC-IR3 or other serial controller

The **VS-5x5** is housed in a 19” 1U rack mountable enclosure, with rack “ears” included and is fed from a 100-240V AC universal switching power supply.

3.1 Defining the VS-5x5 5x5 Video Audio Matrix Switcher

This section defines the **VS-5x5 5x5 Video Audio Matrix Switcher**.

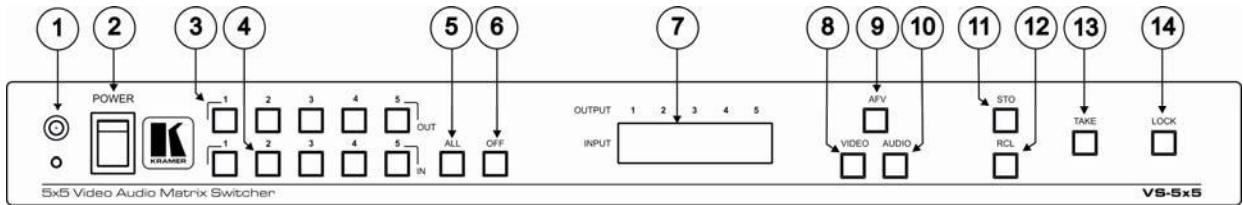

Figure 1: VS-5x5 Video Audio Matrix Switcher - Front Panel

#	Feature	Function
1	IR Receiver	The yellow LED is illuminated when receiving signals from the infrared remote control transmitter
2	POWER Switch	Illuminated switch for turning the unit ON or OFF
3	OUT Buttons	Select the output to which the input is switched
4	IN Buttons	Select the input to switch to the output
5	ALL Button	Pressing ALL followed by an INPUT button, connects that input to all outputs For example, press ALL and then Input button # 2 to connect input # 2 to all the outputs
6	OFF Button	An OFF-OUT combination disconnects that output from the inputs; an OFF-ALL combination disconnects all the outputs
7	7-segment display	Displays the selected audio or video input switched to the output (marked above each input). When audio breakaway mode is selected the Audio button illuminates. When the video breakaway mode is selected the Video button illuminates. Also displays the number of IN and OUT ports, the firmware version number, and the MACHINE #. Refer to Section 7.1
8	VIDEO Button	When pressed actions relate to video. When the video breakaway mode is selected the VIDEO button illuminates
9	AFV Button	When pressed actions relate to video and audio channels. Audio channels follow the video channels. When the AFV mode is selected the AFV button illuminates
10	AUDIO Button	When pressed actions relate to audio. When the audio breakaway mode is selected the AUDIO button illuminates
11	STO (STORE) Button	Pressing STO followed by an output button stores the current setting For example, press STO and then the Output button # 3 to store in Setup # 3
12	RCL (RECALL) Button	Pressing the RCL button and the corresponding OUTPUT key recalls a setup from the non-volatile memory. The stored status flashes. Pressing a different OUTPUT button lets you view another setup. After making your choice, pressing the RCL button again implements the new status Only view, nothing is implemented at this stage
13	TAKE Button	Pressing TAKE toggles the mode between the CONFIRM mode and the AT ONCE mode (user confirmation per action is unnecessary). When in Confirm mode, the TAKE button illuminates
14	LOCK Button	Disengages the front panel switches

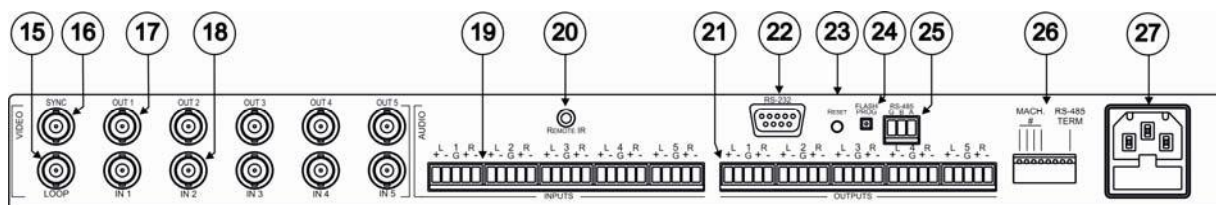

Figure 2: VS-5x5 Video Audio Matrix Switcher - Rear Panel

#	Feature	Function
15	LOOP BNC Connector	For looping the video inputs
16	SYNC BNC Connector	Connects to the external SYNC source
17	Composite BNC OUT Connectors	Connects to the composite video acceptors (from 1 to 5)
18	Composite BNC IN Connectors	Connects to the composite video sources (from 1 to 5)
19	INPUT Terminal Block Connectors	Connect to the balanced stereo audio sources (from 1 to 5)
20	REMOTE IR Socket Covered by a cap. The 3.5mm mini connector at the end of the internal IR connection cable fits through this opening	Connect to an external IR receiver unit for controlling the machine via an IR remote controller instead of using the front panel IR receiver Optional. Can be used instead of the front panel (built-in) IR receiver to remotely control the machine (only if the internal IR connection cable has been installed)
21	OUTPUT Terminal Block Connectors	Connect to the balanced stereo audio acceptors (from 1 to 5)
22	RS-232 9-pin D-sub (F) Port	Connects to the PC or the Remote Controller
23	RESET Button	Press to reset the unit to its original factory settings, or after firmware upgrade
24	FLASH PROG Button	Using a screwdriver if required, push in for "Program" to upgrade to the latest Kramer firmware or release for Normal (the factory default)
25	RS-485 Terminal Block Port	Pin G is for ground connection; pins B (-) and A (+) are for RS-485
26	DIP-switches	DIP-switches for setup of the unit (1, 2, 3 and 4 are for setting the Machine #; 5 is for the Vertical Interval Source; 8 is for RS-485 termination)
27	Power Connector with Fuse	AC connector enabling power supply to the unit

4 Installing in a Rack

Before installing in a rack, be sure that the environment is within the recommended range:

OPERATING TEMPERATURE:	0° to +55°C (32° to 131°F)
STORAGE TEMPERATURE:	-45° to +72°C (-49° to 162°F)
HUMIDITY:	10% to 90%, RHL non-condensing



CAUTION!

When installing on a 19" rack, avoid hazards by taking care that:

1. It is located within the recommended environmental conditions, as the operating ambient temperature of a closed or multi unit rack assembly may exceed the room ambient temperature.
2. Once rack mounted, enough air will still flow around the machine.
3. The machine is placed straight in the correct horizontal position.
4. You do not overload the circuit(s). When connecting the machine to the supply circuit, overloading the circuits might have a detrimental effect on overcurrent protection and supply wiring. Refer to the appropriate nameplate ratings for information. For example, for fuse replacement, see the value printed on the product label.
5. The machine is earthed (grounded) in a reliable way and is connected only to an electricity socket with grounding. Pay particular attention to situations where electricity is supplied indirectly (when the power cord is not plugged directly into the socket in the wall), for example, when using an extension cable or a power strip, and that you use only the power cord that is supplied with the machine.

To rack-mount a machine:

1. Attach both ear brackets to the machine. To do so, remove the screws from each side of the machine (3 on each side), and replace those screws through the ear brackets.

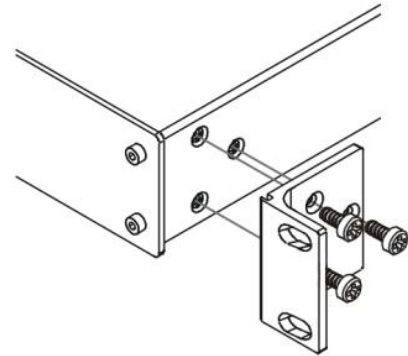

2. Place the ears of the machine against the rack rails, and insert the proper screws (not provided) through each of the four holes in the rack ears.

Note:

- In some models, the front panel may feature built-in rack ears
- Detachable rack ears can be removed for desktop use
- Always mount the machine in the rack before you attach any cables or connect the machine to the power
- If you are using a Kramer rack adapter kit (for a machine that is not 19"), see the Rack Adapters user manual for installation instructions available from our Web site

5 Connecting the VS-5x5 5x5 Video Audio Matrix Switcher



Always switch off the power to each device before connecting it to your **VS-5x5**. After connecting your **VS-5x5**, connect its power and then switch on the power to each device.

This section describes how to connect the **VS-5x5**. In particular, how to:

- Connect the **VS-5x5** rear panel (see [Section 5.1](#))
- Control via RS-232, for example, using a PC (see [Section 5.2](#))
- Control via RS-485 (see [Section 5.3](#))
- Connect the audio inputs/outputs (see [Section 5.4](#))
- Set the DIP-switches (see [Section 5.5](#))

5.1 Connecting the VS-5x5 Rear Panel

To connect the **VS-5x5**, do the following:

Switch OFF the power on each device before connecting it to your VS-5x5. After connecting your VS-5x5, switch on its power and then switch on the power on each device. DO NOT push in the rear panel Flash Program “Program” button and DO NOT push in the underside Flash Program “Reset” button. These are only used for upgrade to the latest Kramer firmware.

1. Connect up to 5 composite video sources (for example, composite video recorders) to the 5 BNC input connectors, and connect up to 5 balanced stereo audio sources to the “AUDIO INPUTS” terminal block connectors.
See [Section 5.4](#) for a description of how to connect a balanced/unbalanced stereo audio input/output
2. Connect the 5 composite video output connectors to up to 5 composite video acceptors and connect the corresponding “AUDIO OUTPUTS” terminal block connectors to the balanced stereo audio acceptors.
When less than five outputs are required, connect only those outputs that are required, and leave the other outputs unconnected
3. Set the DIP-switches (see [Section 5.5](#)).
4. Connect a PC and/or controller (if required) to the RS-232 port (see [Section 5.2](#)) and/or RS-485 port (see [Section 5.3](#)).

5. Connect the power cord.

We recommend that you use only the power cord that is supplied with this machine

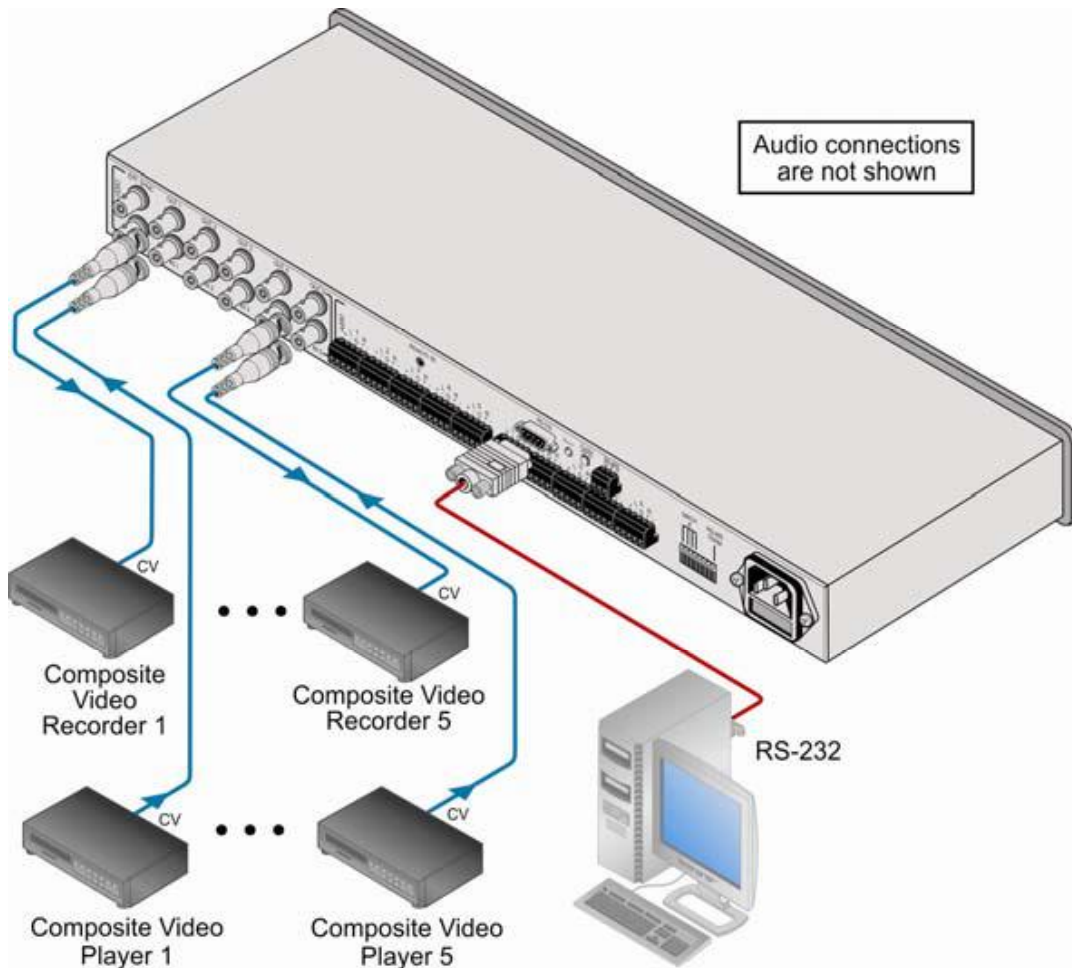

Figure 3: Connecting the VS-5x5 5x5 Video Audio Matrix Switcher

5.2 Connecting to the VS-5x5 via RS-232

You can connect to the unit via a crossed RS-232 connection, using for example, a PC. A crossed cable or null-modem is required as shown in method A and B respectively. If a shielded cable is used, connect the shield to pin 5.

Method A ([Figure 4](#))—Connect the RS-232 9-pin D-sub port on the unit via a crossed cable (only pin 2 to pin 3, pin 3 to pin 2, and pin 5 to pin 5 need be connected) to the RS-232 9-pin D-sub port on the PC.

Note: There is no need to connect any other pins.

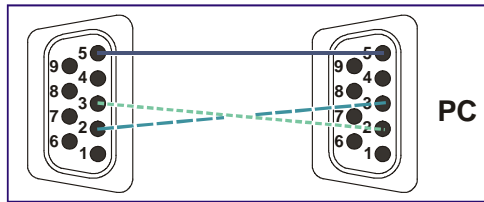

Figure 4: Crossed Cable RS-232 Connection

Hardware flow control is not required for this unit. In the rare case where a controller requires hardware flow control, short pin 1 to 7 and 8, and pin 4 to 6 on the controller side.

Method B (Figure 5)—Connect the RS-232 9-pin D-sub port on the unit via a straight (flat) cable to the null-modem adapter, and connect the null-modem adapter to the RS-232 9-pin D-sub port on the PC. The straight cable usually contains all nine wires for a full connection of the D-sub connector. Because the null-modem adapter (which already includes the flow control jumpering described in Method A above) only requires pins 2, 3 and 5 to be connected, you are free to decide whether to connect only these 3 pins or all 9 pins.

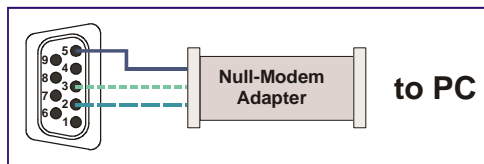

Figure 5: Straight Cable RS-232 Connection with a Null Modem Adapter

5.3 Connecting a PC or Controller to the RS-485 Port

You can operate the **VS-5x5** via the RS-485 port from a distance of up to 1200m (3900ft) using any device equipped with an RS-485 port (for example, a PC). For successful communication, you must set the RS-485 machine number and bus termination.

To connect a device with a RS-485 port to the VS-5x5:

- Connect the A (+) pin on the RS-485 port of the PC to the A (+) pin on the RS-485 port on the rear panel of the **VS-5x5**
- Connect the B (–) pin on the RS-485 port of the PC to the B (–) pin on the RS-485 port on the rear panel of the **VS-5x5**
- Connect the G pin on the RS-485 port of the PC to the G pin on the RS-485 port on the rear panel of the **VS-5x5**

5.4 Connecting a Balanced/Unbalanced Stereo Audio Input/Output

This section illustrates how to wire:

- A balanced stereo audio connection, see [Figure 6](#)
- An unbalanced stereo audio input connection, see [Figure 7](#)
- An unbalanced stereo audio output connection, see [Figure 8](#)

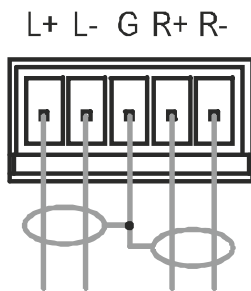

Figure 6: Balanced Stereo Audio Connection

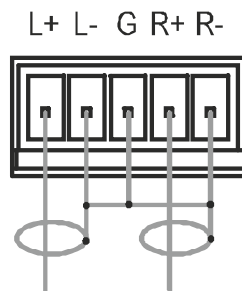

Figure 7: Unbalanced Stereo Audio Input Connection

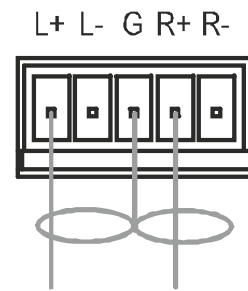

Figure 8: Unbalanced Stereo Audio Output Connection

5.5 Setting the DIP-Switches

[Figure 9](#) describes the factory default DIP-switches.

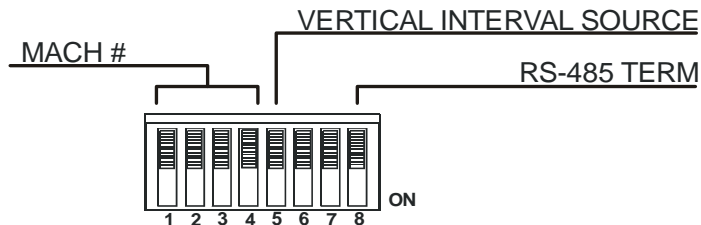

Figure 9: DIP-switch Settings

DIP#	Function	Description
1, 2, 3, 4	Machine #	Determines the position of a unit in the sequence (see Section 5.5.1)
5	Vertical Interval Source	ON for Input # 1 (or programmable) Vertical Interval Source; OFF for External Vertical Interval Source (default) See Section 11 , instruction # 7
6	Reserved	OFF
7	Reserved	OFF
8	RS-485 Termination	ON for RS-485 line termination with 120Ω; OFF for no RS-485 line termination

5.5.1 Setting the MACHINE

The *MACHINE #* determines the position of a **VS-5x5** unit, specifying which **VS-5x5** unit is being controlled when several **VS-5x5** units connect to a PC or serial controller. Set the *MACHINE #* on a **VS-5x5** unit via DIPS 1, 2, 3 and 4, according to the following table.

When using a stand-alone **VS-5x5** unit, set the *MACHINE #* to 1. When connecting more than one **VS-5x5** unit, set the first machine (the Master) that is closest to the PC, as *MACHINE #* 1 (all DIP-switches OFF).

MACHINE #	DIP-SWITCH			
	1	2	3	4
1 (Master)	OFF	OFF	OFF	OFF
2	ON	OFF	OFF	OFF
3	OFF	ON	OFF	OFF
4	ON	ON	OFF	OFF
5	OFF	OFF	ON	OFF
6	ON	OFF	ON	OFF
7	OFF	ON	ON	OFF
8	ON	ON	ON	OFF

6 Controlling via RS-232 and RS-485

You can cascade up to 8 **VS-5x5** units with control from a PC or serial controller.

To cascade up to 8 individual **VS-5x5** units, via RS-232 and RS-485, do the following:

1. Connect the composite video sources and acceptors, as well as the appropriate stereo audio sources and acceptors, as [Section 5.4](#) describes.
2. Connect the RS-232 port on the first **VS-5x5** unit to the PC using the null-modem adapter provided with the machine (recommended), as described in [Section 5.2](#).
Alternatively, the RS-485 port could be used for PC control (instead of RS-232)
3. Connect the RS-485 terminal block port on the first **VS-5x5** unit to the RS-485 port on the second **VS-5x5** unit and so on, connecting all the RS-485 ports as described in [Section 5.3](#).
4. Set the DIP-switches, as described in [Section 5.5](#). In particular:
 - Set the first **VS-5x5** unit as MACHINE # 1 and the following 7 **VS-5x5** units as MACHINE # 2 to MACHINE # 8
 - Set DIP 8 ON at the first and last **VS-5x5** units (terminating the RS-485 line at 120Ω). Set DIP 8 OFF at the other **VS-5x5** units
 - Set DIP 5 to OFF for an external vertical interval source (factory default) or ON for an input #1 (or programmable – see [Section 11](#) instruction # 7) vertical interval source
 - Set DIP 6 and DIP 7 OFF on all **VS-5x5** units

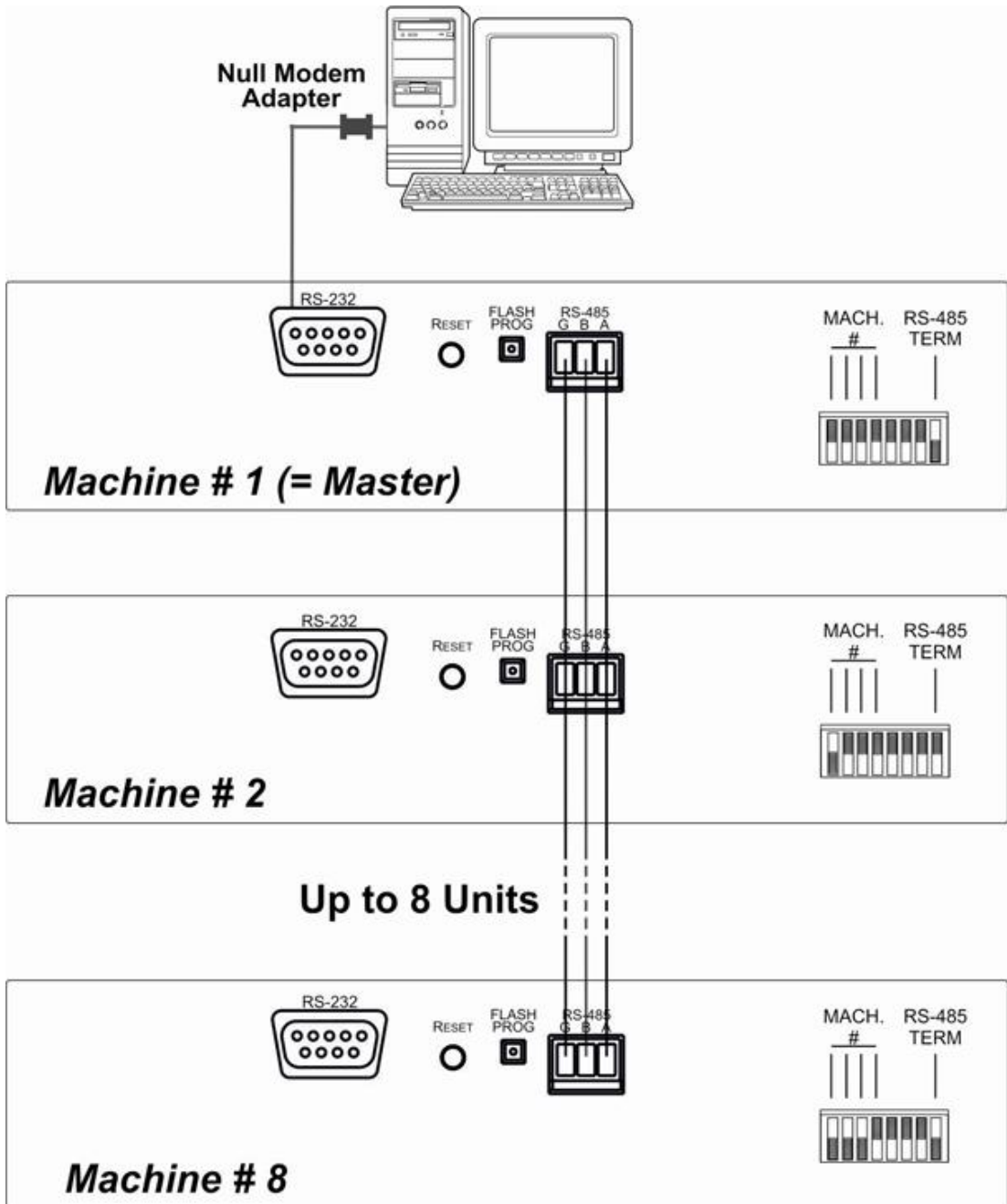

Figure 10: Cascade Configuration for RS-232/RS-485 Control

7 Operating the VS-5x5

You can operate your **VS-5x5** via:

- The front panel buttons
- RS-232/RS-485 serial commands transmitted by a touch screen system, PC, or other serial controller
- RC-IR3 infrared remote control transmitter

7.1 Displaying Unit Characteristics

The **VS-5x5** unit characteristics are displayed in the following circumstances:

- Immediately (and automatically) after switching on the power; and
- When simultaneously pressing the 3 “IN” buttons 1, 2 and 3, for 3 seconds

The following information is displayed in the 7-segment display:

- The number of IN and OUT ports (shown during the “First Display”). The “First Display” appears initially, followed a few seconds later by the “Second Display”
- The firmware version number and the MACHINE # (shown during the “Second Display”)

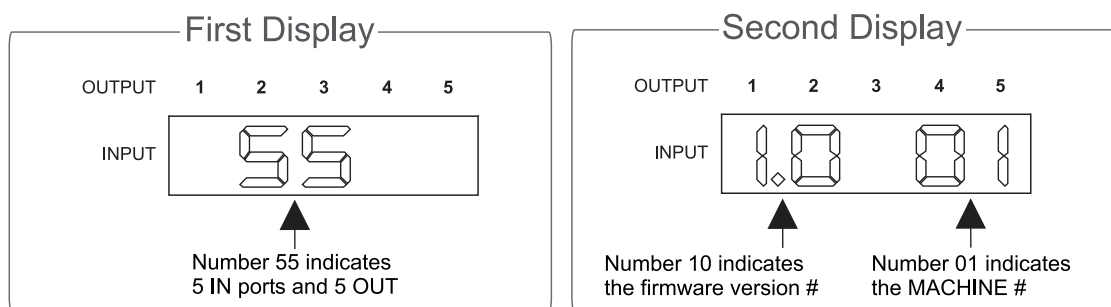

Figure 11: VS-5x5 Unit Characteristics

7.2 Choosing the Audio-Follow-Video or Breakaway Option

You can switch stereo audio signals in one of two ways, either:

- Audio-follow-video (AFV), where all operations and status indicators relate to both the video and the audio channels or
Audio and video connections are the same
- Breakaway, where video and audio channels switch independently

7.2.1 Setting the Audio-Follow-Video Option

To set the audio-follow-video (AFV) option:

1. Press the AFV button.

The AFV button illuminates. The audio follows the video.

- If the audio configuration differs from the video configuration, the audio input(s), to be changed, flash in the 7-segment display and the AUDIO and TAKE buttons also flash.

Warning that changes are about to occur in the audio section

2. Press the TAKE button to confirm the modification (reconfiguring the audio according to the video).

7.2.2 Setting the Breakaway Option

To set the breakaway option, press either the AUDIO (for audio control only) or the VIDEO (for video control only) button.

- If the AUDIO button illuminates, all switching operations, and the 7-segment display, relate to the audio section
- If the VIDEO button illuminates, all switching operations, and the 7-segment display, relate to the video section

7.3 Switching OUT-IN Combinations

To switch a video/audio input to a video/audio output, do the following:

1. Press an OUT button (1, 2, 3, 4 or ALL).
The 7-segment display flashes.

2. Press an IN button (1, 2, 3, 4 or OFF).

The selected input switches to the selected output.

For example, press the ALL button and then IN button # 2 to connect input # 2 to all the outputs.

7.4 Confirming Settings

Choose to work in the AT ONCE or the CONFIRM mode. When the **VS-5x5** operates in the AT ONCE mode (TAKE button is not lit), pressing an OUT-IN combination implements the switch immediately. In the CONFIRM mode (TAKE button is lit), the TAKE button must be pressed to authorize the switch.

In the AT ONCE mode, execution is immediate and actions require no user confirmation. However, no protection is offered against changing an action in error.

In the CONFIRM mode:

- You can key-in several actions and then confirm them by pressing the TAKE button, to simultaneously activate the multiple switches
- Every action requires user confirmation, protecting against erroneous switching
- Execution is delayed until the user confirms the action. Failure to press the TAKE button within one minute (the Timeout) returns abort the action

7.4.1 Toggling between the AT ONCE and CONFIRM Modes

To toggle between the AT ONCE and CONFIRM modes, do the following:

1. Press the dim TAKE button to toggle from the AT ONCE mode (in which the TAKE button is dim) to the CONFIRM mode (in which the TAKE button illuminates).
Actions now require user confirmation and the TAKE button illuminates.
2. Press the illuminated TAKE button to toggle from the CONFIRM mode back to the AT ONCE mode.

Actions no longer require user confirmation and the TAKE button no longer illuminates.

7.4.2 Confirming a Switching Action

To confirm a switching action (in CONFIRM mode), do the following:

1. Press an OUT-IN combination.
The corresponding 7-segment display flashes. The TAKE button also flashes.
2. Press the flashing TAKE button to confirm the action.
The corresponding 7-segment display no longer flashes. The TAKE button illuminates.
3. To confirm several actions (in CONFIRM mode), do the following:
Press each OUT-IN combination in sequence.
The corresponding 7-segment display flashes. The TAKE button also flashes.
4. Press the flashing TAKE button to confirm all the actions.
The corresponding 7-segment display no longer flashes. The TAKE button illuminates.

7.5 Storing/Recalling Input/Output Configurations

You can store and recall up to 10 input/output configurations using the 5 input buttons and the 5 output buttons, as [Figure 12](#) illustrates:

The 10 input/output configurations (or setups) also include the relevant audio-follow-video / breakaway option definition

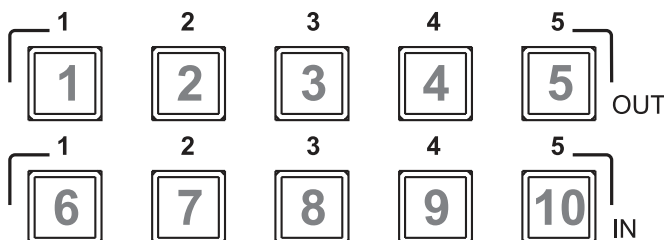

Figure 12: Storing and Recalling using the Input / Output Buttons

The gray numbers (1 to 10) in [Figure 12](#) that illustrate the corresponding store/recall configuration numbers, are for the purpose of illustration only and do not appear on the buttons

7.5.1 Storing an Input/Output Configuration

To store the current status in memory, do the following:

1. Press the STO button.
The STO button flashes.
2. Press one of the 10 input /output buttons (this is the setup # in which the current status is stored). If in the CONFIRM mode, press the flashing TAKE button to confirm the action.
The memory stores the data at that reference.

7.5.2 Recalling an Input/Output Configuration

To recall an input/output configuration, do the following:

1. Press the RCL button.
The RCL button flashes.
2. Press the appropriate Input / Output button (the button # corresponding to the setup #). If in the CONFIRM mode, that setup configuration flashes in the 7-segment display, together with the RCL button and the TAKE button, and only implements after pressing the TAKE button.
The memory recalls the stored data from that reference.



Tip: If you cannot remember which of the 10 input/output configurations is the one that you want, set the **VS-5x5** to the CONFIRM mode and manually scan all the input/output configurations until you locate it.

7.5.3 Deleting an Input/Output Configuration

To delete an input/output configuration, do the following:

1. Press the STO and RCL buttons simultaneously.
Both the STO and RCL buttons flash.
2. Press the appropriate Input / Output button.
This erases that specific input/output configuration from the memory, leaving it empty and available.

Storing a new configuration over a previous configuration (without deleting it first) replaces the previous configuration

7.6 Locking the Front Panel

To prevent changing the settings accidentally or tampering with the unit via the front panel buttons, lock your **VS-5x5**. Unlocking releases the protection mechanism.

Nevertheless, even though the front panel is locked you can still operate via RS-232 or RS-485, as well as via the Kramer

To lock the **VS-5x5**:

- Press the LOCK button for more than two seconds, until the LOCK button is illuminated

The front panel is locked. Pressing a button has no effect, except to cause the LOCK button to flash

Warning that you need to unlock to regain control via the front panel

To unlock the **VS-5x5**:

- Press the illuminated LOCK button for more than two seconds, until the LOCK button is no longer illuminated

The front panel unlocks

7.7 Adjusting the Audio Gain Control

You can adjust the gain control for each input and output using the latest (version 3.9 or higher) K-Router Windows[®]-based control software (provided). (See the tables of Hex Codes for Audio Input/Output Gain Control in [Section 10](#), if you want to program a serial controller to control the audio gain).

8 Technical Specifications

INPUTS:	5 composite video 1Vpp / 75Ω on BNC connectors 5 balanced stereo audio, +4dBm (nominal)/25kΩ on detachable terminal blocks	
OUTPUTS:	5 composite video 1Vpp / 75Ω on BNC connectors 5 balanced stereo audio, +4dBm (nominal)/47Ω on detachable terminal blocks	
MAX. OUTPUT LEVEL:	VIDEO: 2Vpp	AUDIO: +19dBm
BANDWIDTH (-3dB):	VIDEO: 70MHz, fully loaded	AUDIO: 29kHz
DIFF. GAIN:	0.02%	
DIFF. PHASE:	0.44Deg	
K-FACTOR:	<0.05%	
S/N RATIO:	VIDEO: 75.1dB	AUDIO: 74dB
CROSSTALK (all hostile):	VIDEO: -51.4dB @ 5MHz	AUDIO: 105dB
CONTROLS:	Audio gain level control by K-Router software, -91dB to +26dB	
COUPLING:	VIDEO: DC	AUDIO: DC at input, AC at output
AUDIO THD + NOISE:	0.102%	
AUDIO 2nd HARMONIC:	0.053%	
OPERATING TEMPERATURE:	0° to +55°C (32° to 131°F)	
STORAGE TEMPERATURE:	-45° to +72°C (-49° to 162°F)	
HUMIDITY:	10% to 90%, RHL non-condensing	
POWER SOURCE:	100-240V AC, 50/60 Hz; 112mA switching power supply	
DIMENSIONS:	19" x 7" x 1U (W, D, H) rack mountable	
WEIGHT:	2.7 kg (6 lbs.) approx.	
ACCESSORIES:	Power cord, null-modem adapter, Windows®-based Kramer control software, RC-IR3 infrared remote control transmitter	
Specifications are subject to change without notice at http://www.kramerelectronics.com		

9 Table of Hex Codes for Serial Communication

This table lists the Hex values for switching via RS-232/RS-485 a single machine
(*MACHINE # 1*):

	Switching Audio Channels					Switching Video Channels				
	OUT 1	OUT 2	OUT 3	OUT 4	OUT 5	OUT 1	OUT 2	OUT 3	OUT 4	OUT 5
IN 1	02	02	02	02	02	01	01	01	01	01
	81	81	81	81	81	81	81	81	81	81
	81	82	83	84	85	81	82	83	84	85
	81	81	81	81	81	81	81	81	81	81
IN 2	02	02	02	02	02	01	01	01	01	01
	82	82	82	82	82	82	82	82	82	82
	81	82	83	84	85	81	82	83	84	85
	81	81	81	81	81	81	81	81	81	81
IN 3	02	02	02	02	02	01	01	01	01	01
	83	83	83	83	83	83	83	83	83	83
	81	82	83	84	85	81	82	83	84	85
	81	81	81	81	81	81	81	81	81	81
IN 4	02	02	02	02	02	01	01	01	01	01
	84	84	84	84	84	84	84	84	84	84
	81	82	83	84	85	81	82	83	84	85
	81	81	81	81	81	81	81	81	81	81
IN 5	02	02	02	02	02	01	01	01	01	01
	85	85	85	85	85	85	85	85	85	85
	81	82	83	84	85	81	82	83	84	85
	81	81	81	81	81	81	81	81	81	81

10 Tables of Hex Codes for Audio Input/Output Gain Control

Sections [10.1](#) and [10.2](#) contain the tables of hex codes for input and output signal gain control adjustment, respectively.

10.1 Tables of Hex Codes for Audio Input Gain Control

Before adjusting the audio inputs gain, instruction 42, the AUDIO PARAMETER SETTINGS FOR INSTRUCTIONS 22, 24, 25 is sent:

See Protocol 2000 description in [Section 11](#)

2A	86	80	81
----	----	----	----

This command is sent once, and the “audio inputs gain adjustment” mode continues until instruction 42 changes to the “audio outputs gain adjustment” mode.

The next table lists the Hex values for the audio gain control of the 5 inputs.

	INPUTS					
	1	2	3	4	5	ALL
Audio Level = 0	16	16	16	16	16	16
	81	82	83	84	85	80
	80	80	80	80	80	80
	81	81	81	81	81	81
Audio Level = 1	16	16	16	16	16	16
	81	82	83	84	85	80
	81	81	81	81	81	81
	81	81	81	81	81	81
Audio Level = 2	16	16	16	16	16	16
	81	82	83	84	85	80
	82	82	82	82	82	82
	81	81	81	81	81	81
Audio Level = 127	16	16	16	16	16	16
	81	82	83	84	85	80
	FF	FF	FF	FF	FF	FF
	81	81	81	81	81	81
Audio Level = 128	3F	3F	3F	3F	3F	3F
	80	80	80	80	80	80
	81	81	81	81	81	81
	81	81	81	81	81	81
	16	16	16	16	16	16
	81	82	83	84	85	80
	80	80	80	80	80	80
	81	81	81	81	81	81
Audio Level = 216 (1:1)	3F	3F	3F	3F	3F	3F
	80	80	80	80	80	80
	81	81	81	81	81	81
	81	81	81	81	81	81
	16	16	16	16	16	16
	81	82	83	84	85	80
	D8	D8	D8	D8	D8	D8
	81	81	81	81	81	81
Audio Level = 255 (3:1)	3F	3F	3F	3F	3F	3F
	80	80	80	80	80	80
	81	81	81	81	81	81
	81	81	81	81	81	81
	16	16	16	16	16	16
	81	82	83	84	85	80
	FF	FF	FF	FF	FF	FF
	81	81	81	81	81	81

10.2 Tables of Hex Codes for Audio Output Gain Control

Before adjusting the audio outputs gain, instruction 42, the AUDIO PARAMETER SETTINGS FOR INSTRUCTIONS 22, 24, 25 is sent:

See Protocol 2000 description in [Section 11](#)

2A	87	80	81
----	----	----	----

The command is sent once, and the “audio outputs gain adjustment” mode continues until instruction 42 changes to the “audio inputs gain adjustment” mode. The next table lists the Hex values for the audio gain control of the 5 outputs.

	OUTPUTS					
	1	2	3	4	5	ALL
Audio Level = 0 (Mute*)	16	16	16	16	16	16
	81	82	83	84	85	80
	80	80	80	80	80	80
	81	81	81	81	81	81
Audio Level = 1	16	16	16	16	16	16
	81	82	83	84	85	80
	81	81	81	81	81	81
	81	81	81	81	81	81
Audio Level = 2	16	16	16	16	16	16
	81	82	83	84	85	80
	82	82	82	82	82	82
	81	81	81	81	81	81
Audio Level = 127	16	16	16	16	16	16
	81	82	83	84	85	80
	FF	FF	FF	FF	FF	FF
	81	81	81	81	81	81
Audio Level = 128	3F	3F	3F	3F	3F	3F
	80	80	80	80	80	80
	81	81	81	81	81	81
	81	81	81	81	81	81
	16	16	16	16	16	16
	81	82	83	84	85	80
	80	80	80	80	80	80
	81	81	81	81	81	81
Audio Level = 216 (1:1)	3F	3F	3F	3F	3F	3F
	80	80	80	80	80	80
	81	81	81	81	81	81
	81	81	81	81	81	81
	16	16	16	16	16	16
	81	82	83	84	85	80
	D8	D8	D8	D8	D8	D8
	81	81	81	81	81	81
Audio Level = 255 (3:1)	3F	3F	3F	3F	3F	3F
	80	80	80	80	80	80
	81	81	81	81	81	81
	81	81	81	81	81	81
	16	16	16	16	16	16
	81	82	83	84	85	80
	FF	FF	FF	FF	FF	FF
	81	81	81	81	81	81

*In the Mute state, the audio output is physically disconnected from the input

11 Kramer Protocol 2000

The **VS-5x5** is compatible with Kramer's Protocol 2000 (version 0.5) (below). This RS-232 / RS-485 communication protocol uses four bytes of information as defined below. For RS-232, a null-modem connection between the machine and controller is used. The default data rate is 9600 baud, with no parity, 8 data bits and 1 stop bit.

MSB								LSB
		Destination	Instruction					
0	D	N5	N4	N3	N2	N1	N0	
7	6	5	4	3	2	1	0	
1st byte								
		Input						
1	I6	I5	I4	I3	I2	I1	I0	
7	6	5	4	3	2	1	0	
2nd byte								
		Output						
1	O6	O5	O4	O3	O2	O1	O0	
7	6	5	4	3	2	1	0	
3rd byte								
		Machine Number						
1	OVR	X	M4	M3	M2	M1	M0	
7	6	5	4	3	2	1	0	
4th byte								

1st BYTE: Bit 7 – Defined as 0.

D – “DESTINATION”: 0 - for sending information to the switchers (from the PC);

1 - for sending to the PC (from the switcher).

N5...N0 – “INSTRUCTION”

The function that is to be performed by the switcher(s) is defined by the INSTRUCTION (6 bits).

Similarly, if a function is performed via the machine's keyboard, then these bits are set with the INSTRUCTION NO., which was performed. The instruction codes are defined according to the table below (INSTRUCTION NO. is the value to be set for N5...N0).

2nd BYTE: Bit 7 – Defined as 1.

I6...I0 – “INPUT”.

When switching (ie. instruction codes 1 and 2), the INPUT (7 bits) is set as the input number which is to be switched. Similarly, if switching is done via the machine's front-panel, then these bits are set with the INPUT NUMBER which was switched. For other operations, these bits are defined according to the table.

3rd BYTE: Bit 7 – Defined as 1.

O6...O0 – “OUTPUT”.

When switching (ie. instruction codes 1 and 2), the OUTPUT (7 bits) is set as the output number which is to be switched. Similarly, if switching is done via the machine's front-panel, then these bits are set with the OUTPUT NUMBER which was switched. For other operations, these bits are defined according to the table.

4th BYTE: Bit 7 – Defined as 1.

Bit 5 – Don't care.

OVR – Machine number override.

M4...M0 – MACHINE NUMBER.

Used to address machines in a system via their machine numbers. When several machines are controlled from a single serial port, they are usually configured together with each machine having an individual machine number. If the OVR bit is set, then all machine numbers will accept (implement) the command, and the addressed machine will reply.

For a single machine controlled via the serial port, always set M4...M0 = 1, and make sure that the machine itself is configured as MACHINE NUMBER = 1.

Instruction		Definition For Specific Instruction		
#	Description	Input	Output	Note
0, 18	RESET	0	0	1
1	SWITCH VIDEO	Set equal to video input which is to be switched (0 = disconnect)	Set equal to video output which is to be switched (0 = to all the outputs)	2, 15
2	SWITCH AUDIO	Set equal to audio input which is to be switched (0 = disconnect)	Set equal to audio output which is to be switched (0 = to all the outputs)	2
3, 19	STORE VIDEO and AUDIO STATUS	Set as SETUP #	0 - to store 1 - to delete	2, 3, 15
4, 20	RECALL VIDEO STATUS	Set as SETUP #	0	2, 3, 15
5	REQUEST STATUS OF A VIDEO OUTPUT	Set as SETUP #	Equal to output number whose status is required	4, 3
6	REQUEST STATUS OF AN AUDIO OUTPUT	Set as SETUP #	Equal to output number whose status is required	4, 3
7	VIS SOURCE	Set as input # (for OUTPUT byte = 6) or set = 0	0 - No VIS (immediate) 1 - Input # 1 3 - External analog sync 4 - Dynamic sync 6 - Input # (INPUT byte)	2, 5, 17, 17A
8	BREAKAWAY SETTING	0	0 - audio-follow-video 1 - audio breakaway	2
10	REQUEST VIS SETTING	Set as SETUP #, or set to 126 or 127 to request if machine has this function	0 - VIS source	3, 4, 6, 7
11	REQUEST BREAKAWAY SETTING	Set as SETUP #, or set to 126 or 127 to request if machine has this function	0 - Request audio breakaway setting 1 - Request "FOLLOW" setting	3, 4, 6, 15
12	REQUEST VIDEO / AUDIO TYPE SETTING	Set as SETUP #, or set to 126 or 127 to request if machine has this function	0 - for video 1 - for audio	3, 4, 6
15	REQUEST WHETHER SETUP IS DEFINED	Set as SETUP #	0	8
16	ERROR / BUSY	0	0 - error 1 - invalid instruction 2 - out of range	9
22	SET AUDIO PARAMETER	Equal to input / output number whose gain is to be set (0 = all)	Set as parameter value	2, 11, 23
24	INCREASE / DECREASE AUDIO PARAMETER	Equal to input / output number whose parameter is to be increased / decreased (0 = all)	0 - increase output 1 - decrease output 6 - increase input 7 - decrease input	23
25	REQUEST AUDIO PARAMETER	Equal to input / output number whose parameter is requested	0	6, 23
30	LOCK FRONT PANEL	0 - Panel unlocked 1 - Panel locked	0	2
31	REQUEST WHETHER PANEL IS LOCKED	0	0	16
42	AUDIO PARAMETER SETTINGS FOR INSTRUCTIONS 22, 24, 25	INPUT Bit: I0 - 0=input; 1=output I1 - Left I2 - Right	0 - Gain	23

Instruction		Definition For Specific Instruction		
#	Description	Input	Output	Note
57	SET AUTO-SAVE	13 - no save 14 - auto-save	0	12, 2
61	IDENTIFY MACHINE	1 - video machine name 2 - audio machine name 3 - video software version 4 - audio software version	0 - Request first 4 digits	13
62	DEFINE MACHINE	1 - number of inputs 2 - number of outputs 3 - number of setups	1 - for video 2 - for audio	14
63	EXTENDED DATA	7 MSBs for INPUT data	7 MSBs for OUTPUT data	19

NOTES on the above table:

NOTE 1 - When the master switcher is reset, (e.g. when it is turned on), the reset code is sent to the PC. If this code is sent to the switchers, it resets according to the present power-down settings.

NOTE 2 - These are bi-directional definitions. That is, if the switcher receives the code, it performs the instruction; and if the instruction is performed (due to a keystroke operation on the front panel), then these codes are sent. For example, if the HEX code

01 85 88 83

was sent from the PC, then the switcher (machine 3) switches input 5 to output 8. If the user switched input 1 to output 7 via the front panel keypad, then the switcher sends HEX codes:

41 81 87 83

to the PC.

When the PC sends one of the commands in this group to the switcher, then, if the instruction is valid, the switcher replies by sending to the PC the same four bytes that it was sent (except for the first byte, where the DESTINATION bit is set high).

NOTE 3 - SETUP # 0 is the present setting. SETUP # 1 and higher are the settings saved in the switcher's memory, (i.e. those used for Store and Recall).

NOTE 4 - The reply to a "REQUEST" instruction is as follows: the same instruction and INPUT codes as were sent are returned, and the OUTPUT is assigned the value of the requested parameter. The replies to instructions 10 and 11 are as per the definitions in instructions 7 and 8 respectively. For example, if the present status of machine number 5 is breakaway setting, then the reply to the HEX code

0B 80 80 85

would be HEX codes

4B 80 81 85

NOTE 5 – For the OUTPUT byte set as 6, the VIS source is the input selected using the OUTPUT byte. Similarly, for the OUTPUT byte set as 7, the VIS source is the output selected using the OUTPUT byte. Note also, that on some machines the sync source is not software selectable, but is selected using switches, jumpers, etc!

NOTE 6 – If INPUT is set to 127 for these instructions, then, if the function is defined on this machine, it replies with OUTPUT=1. If the function is not defined, then the machine replies with OUTPUT=0, or with an error (invalid instruction code).

If the INPUT is set to 126 for these instructions, then, if possible, the machine returns the current setting of this function, even for the case that the function is not defined. For example, for a video switcher which always switches during the VIS of input #1, (and its VIS setting cannot be programmed otherwise), the reply to the HEX code

0A FE 80 81 (i.e. request VIS setting, with INPUT set as 126dec)

would be HEX codes

4A FE 81 81 (i.e. VIS setting = 1, which is defined as VIS from input #1).

NOTE 7 – Setting OUTPUT to 0 returns the VIS source setting as defined in instruction #7. Setting to 1 returns the input # or output # of the sync source (for the case where the VIS source is set as 6 or as 7 in instruction #7). Setting to 2 returns the vertical sync frequency (0 for no input sync, 50 for PAL, 60 for NTSC, 127 for error).

NOTE 8 - The reply to the "REQUEST WHETHER SETUP IS DEFINED" is as in TYPE 3 above, except that here the OUTPUT is assigned with the value 0 if the setup is not defined; or 1 if it is defined.

NOTE 9 - An error code is returned to the PC if an invalid instruction code was sent to the switcher, or if a parameter associated with the instruction is out of range (e.g. trying to save to a setup greater than the highest one, or trying to switch an input or output greater than the highest one defined). This code is also returned to the PC if an RS-232 instruction is sent while the machine is being programmed via the front panel. Reception of this code by the switcher is not valid.

NOTE 10 – This code is reserved for internal use.

NOTE 11 – For machines where the video and / or audio gain is programmable.

NOTE 12 - Under normal conditions, the machine's present status is saved each time a change is made. The "power-down" save (auto-save) may be disabled using this code. Note that whenever the machine is turned on, the auto-save function is set.

NOTE 13 - This is a request to identify the switcher/s in the system. If the OUTPUT is set as 0, and the INPUT is set as 1, 2, 5 or 7, the machine sends its name. The reply is the decimal value of the INPUT and OUTPUT. For example, for a 2216, the reply to the request to send the audio machine name would be (HEX codes):

7D 96 90 81 (i.e. 128dec+ 22dec for 2nd byte, and 128dec+ 16dec for 3rd byte).

If the request for identification is sent with the INPUT set as 3 or 4, the appropriate machine sends its software version number. Again, the reply would be the decimal value of the INPUT and OUTPUT - the INPUT representing the number in front of the decimal point, and the OUTPUT representing the number after it. For example, for version 3.5, the reply to the request to send the version number would be (HEX codes):

7D 83 85 81 (i.e. 128dec+ 3dec for 2nd byte, 128dec+ 5dec for 3rd byte).

If the OUTPUT is set as 1, then the ASCII coding of the lettering following the machine's name is sent. For example, for the VS-7588YC, the reply to the request to send the first suffix would be (HEX codes):

7DD9 C3 81 (i.e. 128dec+ ASCII for "Y"; 128dec+ ASCII for "C").

NOTE 14 - The number of inputs and outputs refers to the specific machine, which is being addressed, not to the system. For example, if six 16X16 matrices are configured to make a 48X32 system (48 inputs, 32 outputs), the reply to the HEX code

3E 82 81 82 (ie. request the number of outputs)

would be HEX codes

7E 82 90 82

i.e. 16 outputs

NOTE 15 – When the OVR bit (4th byte) is set, then the "video" commands have universal meaning. For example, instruction 1 (SWITCH VIDEO) causes all units (including audio, data, etc.) to switch. Similarly, if a machine is in "FOLLOW" mode, it performs any "video" instruction.

NOTE 16 - The reply to the "REQUEST WHETHER PANEL IS LOCKED" is as in NOTE 4 above, except that here the OUTPUT is assigned with the value 0 if the panel is unlocked, or 1 if it is locked.

NOTE 17 – Delayed execution allows switching after a delay dictated by RS-232. To do this, the user sends instruction 7 with the "Set for delayed switch" option (64dec) before sending the switch command (instruction 1) or pressing via front panel. The switch is not executed (unless timed-out) until the "Execute delayed switch" code is sent, or the "Set for delayed switch" code is sent again. (The mode is automatically cancelled after implementation of the switch if the "execute" command is used).

For example, to connect input 4 to output 3 after a delay, send HEX codes

07 80 C0 81 (set for delayed switch)

01 84 83 81 (switch code)

then, after the required delay, send HEX codes

07 80 C1 81 (execute delayed switch)

to implement the switch.

NOTE 17A – For clean switching of RGBHV video, the "seamless switching" option may be used. The blanking period for the transition of the RGB sources may be set in this case, in steps of 25 milliseconds. For example, to set for 350ms blanking time (14 steps), send HEX codes:

07 8E A0 81

NOTE 18 – After this instruction is sent, the unit responds to the ASCII command set. The ASCII command to operate with the HEX command set must be sent in order to return to working with HEX codes.

NOTE 19 – When data (i.e. the INPUT and/or OUTPUT bytes) of more than 7 bits is required, this instruction is sent before sending the instruction needing the additional bits. The data in this instruction then becomes the Most Significant Bits of that next instruction. For example, to set the audio gain (instruction 22) of output 3 to 681dec (2A9hex), you would first send HEX codes

3F 80 85 81

and then send HEX codes

16 83 A9 81

To set the audio gain of output 6 to 10013dec (271Dhex), first send HEX codes

3F 80 CE 81

followed by HEX codes

16 86 9D 81

NOTE 20 – To store data in the non-volatile memory of the unit, e.g. the EEPROM for saving SETUPS. The EEPROM address is sent using the INPUT byte, and the data to be stored is sent using the OUTPUT byte. To use this instruction, it is necessary to understand the memory map, and memory structure of the particular machine.

NOTE 21 – Instruction 59 and instruction 60 load data for sending to the cross point switcher (or for storing in a SETUP), i.e. the data is “lined-up” to be executed later. Instruction 58 executes the loaded data.

NOTE 22 – If the INPUT byte is set as 127dec, then the data stored in a SETUP is loaded. The SETUP # is in the OUTPUT byte.

NOTE 23 – Further information needed in instructions 21, 22, 25 and 26, is sent using instruction 42 – which is sent prior to the instruction. For example, to request the audio gain value of right input # 9, send hex codes

2A 84 80 81

and then send HEX codes

19 89 81 81

LIMITED WARRANTY

We warrant this product free from defects in material and workmanship under the following terms.

HOW LONG IS THE WARRANTY

Labor and parts are warranted for seven years from the date of the first customer purchase.

WHO IS PROTECTED?

Only the first purchase customer may enforce this warranty.

WHAT IS COVERED AND WHAT IS NOT COVERED

Except as below, this warranty covers all defects in material or workmanship in this product. The following are not covered by the warranty:

1. Any product which is not distributed by us or which is not purchased from an authorized Kramer dealer. If you are uncertain as to whether a dealer is authorized, please contact Kramer at one of the agents listed in the Web site www.kramerelectronics.com.
2. Any product, on which the serial number has been defaced, modified or removed, or on which the WARRANTY VOID IF TAMPERED sticker has been torn, reattached, removed or otherwise interfered with.
3. Damage, deterioration or malfunction resulting from:
 - i) Accident, misuse, abuse, neglect, fire, water, lightning or other acts of nature
 - ii) Product modification, or failure to follow instructions supplied with the product
 - iii) Repair or attempted repair by anyone not authorized by Kramer
 - iv) Any shipment of the product (claims must be presented to the carrier)
 - v) Removal or installation of the product
 - vi) Any other cause, which does not relate to a product defect
 - vii) Cartons, equipment enclosures, cables or accessories used in conjunction with the product

WHAT WE WILL PAY FOR AND WHAT WE WILL NOT PAY FOR

We will pay labor and material expenses for covered items. We will not pay for the following:

1. Removal or installations charges.
2. Costs of initial technical adjustments (set-up), including adjustment of user controls or programming. These costs are the responsibility of the Kramer dealer from whom the product was purchased.
3. Shipping charges.

HOW YOU CAN GET WARRANTY SERVICE

1. To obtain service on you product, you must take or ship it prepaid to any authorized Kramer service center.
2. Whenever warranty service is required, the original dated invoice (or a copy) must be presented as proof of warranty coverage, and should be included in any shipment of the product. Please also include in any mailing a contact name, company, address, and a description of the problem(s).
3. For the name of the nearest Kramer authorized service center, consult your authorized dealer.

LIMITATION OF IMPLIED WARRANTIES

All implied warranties, including warranties of merchantability and fitness for a particular purpose, are limited in duration to the length of this warranty.

EXCLUSION OF DAMAGES

The liability of Kramer for any effective products is limited to the repair or replacement of the product at our option. Kramer shall not be liable for:

1. Damage to other property caused by defects in this product, damages based upon inconvenience, loss of use of the product, loss of time, commercial loss; or:
2. Any other damages, whether incidental, consequential or otherwise. Some countries may not allow limitations on how long an implied warranty lasts and/or do not allow the exclusion or limitation of incidental or consequential damages, so the above limitations and exclusions may not apply to you.

This warranty gives you specific legal rights, and you may also have other rights, which vary from place to place.

NOTE: All products returned to Kramer for service must have prior approval. This may be obtained from your dealer.

This equipment has been tested to determine compliance with the requirements of:

- EN-50081: "Electromagnetic compatibility (EMC);
generic emission standard.
Part 1: Residential, commercial and light industry"
- EN-50082: "Electromagnetic compatibility (EMC) generic immunity standard.
Part 1: Residential, commercial and light industry environment".
- CFR-47: FCC* Rules and Regulations:
Part 15: "Radio frequency devices
Subpart B Unintentional radiators"

CAUTION!

► Servicing the machines can only be done by an authorized Kramer technician. Any user who makes changes or modifications to the unit without the expressed approval of the manufacturer will void user authority to operate the equipment.

► Use the supplied DC power supply to feed power to the machine.

► Please use recommended interconnection cables to connect the machine to other components.

* FCC and CE approved using STP cable (for twisted pair products)



For the latest information on our products and a list of Kramer distributors, visit our Web site where updates to this user manual may be found.

We welcome your questions, comments, and feedback.

Web site: www.kramerelectronics.com

E-mail: info@kramereel.com



SAFETY WARNING

Disconnect the unit from the power supply before opening and servicing