



KRAMER ELECTRONICS LTD.

USER MANUAL

MODEL:

VS-66HN

6x6 HDMI Matrix Switcher

P/N: 2900-300154 Rev 1.1



VS-66HN Quick Start Guide

This guide helps you install and use your product for the first time. For more detailed information, go to <http://bit.ly/k-prod-downloads> to download the latest manual or scan the QR code on the left.

Step 1: Check what's in the box

- VS-66HN 6x6 HDMI Matrix Switcher
- 1 Power cord
- 1 Set of rack "ears"
- 4 Rubber feet
- 1 Quick Start Guide
- Kramer RC-IR3 Infrared Remote Control Transmitter with batteries and user manual

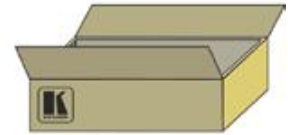

Step 2: Install the VS-66HN

Mount the machine in a rack (using the included rack "ears") or attach the rubber feet and place on a table.

Step 3: Connect the inputs and outputs

Always switch off the power on each device before connecting it to your VS-66HN.

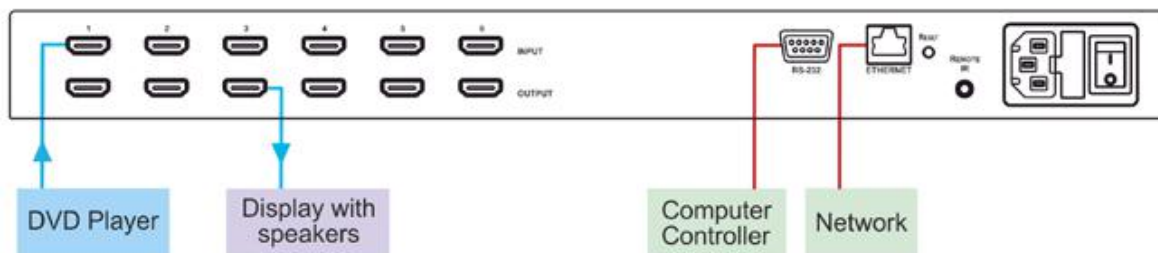

Always use Kramer high-performance cables for connecting AV equipment to the VS-66HN.

Step 4: Connect the power

Connect the power cord to the VS-66HN and plug it into the mains electricity.



Step 5: Operate the VS-66HN

Switch an Input to an Output

- Press an output button followed by an input button to switch the pair

Acquire the EDID from an Output

1. Press the EDID and STO buttons simultaneously and hold them for 3 seconds.
2. Press the input button to which the EDID is to be copied.
3. Select the output from which the EDID is to be acquired.
4. Press the EDID button.

Set the EDID to Default

1. Press the EDID and STO buttons simultaneously and hold them for 3 seconds.
2. Press the input button to which the EDID is to be copied.
3. Press the OFF button until "0" (zero) appears on the display.
4. Press the EDID button.

Contents

1	Introduction	1
2	Getting Started	2
2.1	Achieving the Best Performance	2
2.2	Safety Instructions	3
2.3	Recycling Kramer Products	3
3	Overview	4
3.1	About Fast Switching	5
3.2	Defining the VS-66HN 6x6 HDMI Matrix Switcher	5
3.3	Using the IR Transmitter	8
4	Installing in a Rack	9
5	Connecting the VS-66HN 6x6 HDMI Matrix Switcher	10
6	Operating the VS-66HN 6x6 HDMI Matrix Switcher	12
6.1	Switching an Input to an Output	12
6.2	Acquiring the EDID	12
6.3	Storing and Recalling a Preset	14
6.4	Changing the Port Switching Speed	15
6.5	Setting HDCP to On/Off	16
6.6	Resetting the IP Parameters	17
6.7	Switching Between Protocol 2000 and Protocol 3000	17
6.8	Connecting via RS-232	17
6.9	Connecting via Ethernet	18
6.10	Upgrading the Firmware	18
7	Technical Specifications	19
8	Default Communication Parameters	20
9	Default EDID	21
10	Kramer Protocol 2000	24
11	Protocol 3000	27
11.1	Kramer Protocol 3000 Syntax	27
11.2	Kramer Protocol 3000 Commands	30
11.3	Kramer Protocol 3000 – Detailed Commands	31

Figures

Figure 1: VS-66HN 6x6 HDMI Matrix Switcher Front Panel	6
Figure 2: VS-66HN 6x6 HDMI Matrix Switcher Rear Panel	7
Figure 3: Connecting the VS-66HN 6x6 HDMI Matrix Switcher	11
Figure 4: Store-Recall Button Configuration	14

1 Introduction

Welcome to Kramer Electronics! Since 1981, Kramer Electronics has been providing a world of unique, creative, and affordable solutions to the vast range of problems that confront video, audio, presentation, and broadcasting professionals on a daily basis. In recent years, we have redesigned and upgraded most of our line, making the best even better!

Our 1,000-plus different models now appear in 14 groups that are clearly defined by function: GROUP 1: Distribution Amplifiers; GROUP 2: Switchers and Routers; GROUP 3: Control Systems; GROUP 4: Format/Standards Converters; GROUP 5: Range Extenders and Repeaters; GROUP 6: Specialty AV Products; GROUP 7: Scan Converters and Scalers; GROUP 8: Cables and Connectors; GROUP 9: Room Connectivity; GROUP 10: Accessories and Rack Adapters; GROUP 11: Sierra Video Products; GROUP 12: Digital Signage; GROUP 13: Audio; and GROUP 14: Collaboration.

Congratulations on purchasing your Kramer **VS-66HN** *6x6 HDMI Matrix Switcher*, which is ideal for the following typical applications:

- Conference room presentations
- Advertising applications
- Rental and staging

2 Getting Started

We recommend that you:

- Unpack the equipment carefully and save the original box and packaging materials for possible future shipment
- Review the contents of this user manual



Go to www.kramerav.com/support/product_downloads.asp to check for up-to-date user manuals, application programs, and to check if firmware upgrades are available (where appropriate).

2.1 Achieving the Best Performance

To achieve the best performance:

- Use only good quality connection cables (we recommend Kramer High-performance high-resolution cables) to avoid interference, deterioration in signal quality due to poor matching, and elevated noise levels (often associated with low quality cables)
- Do not secure the cables in tight bundles or roll the slack into tight coils
- Avoid interference from neighboring electrical appliances that may adversely influence signal quality
- Position your Kramer **VS-66HN** away from moisture, excessive sunlight and dust



This equipment is to be used only inside a building. It may only be connected to other equipment that is installed inside a building.

2.2 Safety Instructions



Caution: There are no operator serviceable parts inside the unit

Warning: Use only the power cord that is supplied with the unit

Warning: Do not open the unit. High voltages can cause electrical shock! Servicing by qualified personnel only

Warning: Disconnect the power and unplug the unit from the wall before installing

2.3 Recycling Kramer Products

The Waste Electrical and Electronic Equipment (WEEE) Directive 2002/96/EC aims to reduce the amount of WEEE sent for disposal to landfill or incineration by requiring it to be collected and recycled. To comply with the WEEE Directive, Kramer Electronics has made arrangements with the European Advanced Recycling Network (EARN) and will cover any costs of treatment, recycling and recovery of waste Kramer Electronics branded equipment on arrival at the EARN facility. For details of Kramer's recycling arrangements in your particular country go to our recycling pages at www.kramerav.com/support/recycling/.

3 Overview

The **VS-66HN** is a high quality 6x6 matrix switcher for HDMI signals. It reclocks and equalizes the signal and can route any input to any or all outputs simultaneously.

In particular, the **VS-66HN** features:

- Up to 6.75Gbps data rate (2.25Gbps per graphics channel)
Suitable for resolutions up to UXGA at 60Hz and for all HD resolutions.
- Support for HDCP (High Definition Digital Content Protection)
- HDMI Support - HDMI support for Deep Color, x.v.Color™, Dolby® TrueHD, Dolby Digital Plus, DTS-HD®, and linear PCM 7.1 surround sound
- 3D pass-through
- Kramer reKlocking™ & Equalization Technology that rebuilds the digital signal to travel longer distances
- A lock button to prevent unwanted tampering with the buttons on the front panel
- 12 Preset memory locations for quick access to common configurations

You can control the **VS-66HN** using the front panel buttons, or remotely via:

- RS-232 serial commands transmitted by a PC, touch screen system or other serial controller
- The Kramer infrared remote control transmitter
- A PC connected to the Ethernet port on the device via a LAN
- An external remote IR receiver (optional), see [Section 3.3](#)

3.1 About Fast Switching

Older display devices required a longer time between the loss of one digital signal and the introduction of another, as well as a physical disconnection of the interconnecting cable in order to be able to detect and adjust to the new video attributes and parameters. Normal switching, therefore, introduced a 5V signal disconnection along with a delay in switching. Many newer display devices, however, are now capable of “on-the-fly” switching.

Depending on the display device in use, the **VS-66HN** allows for fast switching (minor reset and the connection kept alive) and extra fast switching (no reset and the connection kept alive). Using the fast and extra fast switching modes allows for fraction-of-a-second switching times when using high performance display devices or when using a scaler on the video output.

3.2 Defining the VS-66HN 6x6 HDMI Matrix Switcher

This section defines the **VS-66HN**.

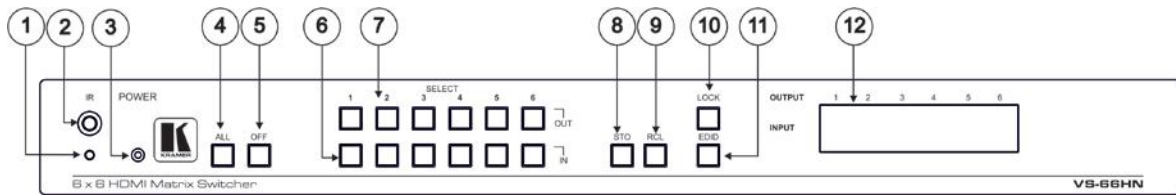

Figure 1: VS-66HN 6x6 HDMI Matrix Switcher Front Panel

#	Feature	Function	
1	IR Indication LED	Lights yellow when receiving signals from the infrared remote control transmitter	
2	IR Receiver	Signal receiver for the infrared remote control transmitter	
3	POWER LED	Lights when the device is turned on	
4	ALL Button	Press followed by an input button to connect the selected input to all outputs For example, press ALL and then Input button # 2 to connect input # 2 to all the outputs	
5	OFF Button	Press after pressing an output button to disconnect the selected output from the inputs. To disconnect all the outputs, press ALL followed by OFF	
6	SELECT Buttons	IN (1 to 6)	Press to select the input to switch after selecting an output (also used for storing machine setups (see Section 6.3))
7		OUT (1 to 6)	Press to select an output to switch followed by an input (also used for storing machine setups (see Section 6.3))
8	STO Button	Press to store the current switching setting to a preset (see Section 6.3)	
9	RCL Button	Press to recall the current switching setting from a preset (see Section 6.3)	
10	LOCK Button	Press and hold to toggle the locking/release of the front panel buttons. When storing or recalling presets, press to store or recall the preset (see Section 6.3)	
11	EDID Button	Press to capture the EDID (see Section 6.2)	
12	INPUT 7-segment LED Display	Displays the input currently switched to the output which is marked above each input	

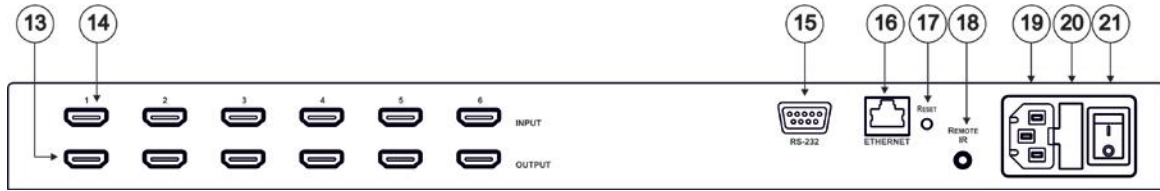

Figure 2: VS-66HN 6x6 HDMI Matrix Switcher Rear Panel

#	Feature	Function
13	OUTPUT HDMI Connectors (1 to 6)	Connect to up to 6 HDMI acceptors
14	INPUT HDMI Connectors (1 to 6)	Connect to up to 6 HDMI sources
15	RS-232 9-pin D-sub Connector	Connect to a PC/serial controller
16	ETHERNET RJ-45 Connector	Connect to a PC via a LAN
17	RESET Button	Press to reset to the factory default IP parameters: IP number – 192.168.1.39 Mask – 255.255.255.0 Gateway – 192.168.1.1 Depress the button while powering on the device. The device powers up with the factory default IP parameters
18	REMOTE IR Opening	Connect to an external IR receiver for controlling the device via and IR remote controller (see Section 3.3) Covered by a cap. The 3.5mm jack at the end of the internal IR connection cable fits into this opening
19	Mains Power Connector	Connect to the mains power
20	Mains Power Fuse	Fuse for protecting the device
21	Mains Power Switch	Switch for turning the device on or off

3.3 Using the IR Transmitter

You can use the **RC-IR3** IR transmitter to control the machine via the built-in IR receiver on the front panel or, instead, via an optional external IR receiver (Model: C-A35M/IRR-50). The external IR receiver can be located up to 15 meters away from the machine. This distance can be extended to up to 60 meters when used with three extension cables (Model: C-A35M/A35F-50).

Before using the external IR receiver, be sure to arrange for your Kramer dealer to insert the internal IR connection cable (P/N: 505-70434010-S) with the 3.5mm connector that fits into the REMOTE IR opening on the rear panel. Connect the external IR receiver to the REMOTE IR 3.5mm connector.



Note that the IR transmitter can control the **VS-66HN** only when it is set to the P2000 mode.

[Section 6.7](#) and [Section 8](#) describe how to switch between Protocol 3000 and Protocol 2000.

When used in conjunction with the IR transmitter, the **VS-66HN** can be operated using serial commands from a PC, remote controller or touch screen using Protocol 2000 only.

4 Installing in a Rack

This section provides instructions for rack mounting the unit.

Before installing in a rack, be sure that the environment is within the recommended range:

OPERATING TEMPERATURE:	0° to +40°C (32° to 104°F)
STORAGE TEMPERATURE:	-40° to +70°C (-40° to 158°F)
HUMIDITY:	10% to 90%, RHL non-condensing



CAUTION!

When installing on a 19" rack, avoid hazards by taking care that:

1. It is located within the recommended environmental conditions, as the operating ambient temperature of a closed or multi unit rack assembly may exceed the room ambient temperature.
2. Once rack mounted, enough air will still flow around the machine.
3. The machine is placed straight in the correct horizontal position.
4. You do not overload the circuit(s). When connecting the machine to the supply circuit, overloading the circuits might have a detrimental effect on overcurrent protection and supply wiring. Refer to the appropriate nameplate ratings for information. For example, for fuse replacement, see the value printed on the product label.
5. The machine is earthed (grounded) in a reliable way and is connected only to an electricity socket with grounding. Pay particular attention to situations where electricity is supplied indirectly (when the power cord is not plugged directly into the socket in the wall), for example, when using an extension cable or a power strip, and that you use only the power cord that is supplied with the machine.

To rack-mount a machine:

1. Attach both ear brackets to the machine. To do so, remove the screws from each side of the machine (3 on each side), and replace those screws through the ear brackets.

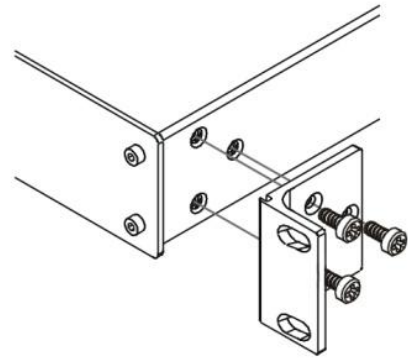

2. Place the ears of the machine against the rack rails, and insert the proper screws (not provided) through each of the four holes in the rack ears.

Note:

- In some models, the front panel may feature built-in rack ears
- Detachable rack ears can be removed for desktop use
- Always mount the machine in the rack before you attach any cables or connect the machine to the power
- If you are using a Kramer rack adapter kit (for a machine that is not 19"), see the Rack Adapters user manual for installation instructions available from our Web site

5 Connecting the VS-66HN 6x6 HDMI Matrix Switcher



Always switch off the power to each device before connecting it to your **VS-66HN**. After connecting your **VS-66HN**, connect its power and then switch on the power to each device.

To connect the VS-66HN 6x6 HDMI Matrix Switcher as illustrated in the example in [Figure 3](#):

1. Connect up to six HDMI sources (for example, DVD players) to the IN HDMI connectors.
You do not have to connect all the sources.
2. Connect the six OUT HDMI connectors to up to six HDMI acceptors (for example, LCD displays with built-in speakers).
You do not have to connect all the outputs.
3. If required, connect a PC/controller to the RS-232 port (see [Section 6.8](#)) and/or the Ethernet port (see [Section 6.9](#)).
4. Connect the device to the mains electricity (not shown in [Figure 3](#)).
5. Power the device.
6. If necessary, acquire the EDID (see [Section 6.2](#))

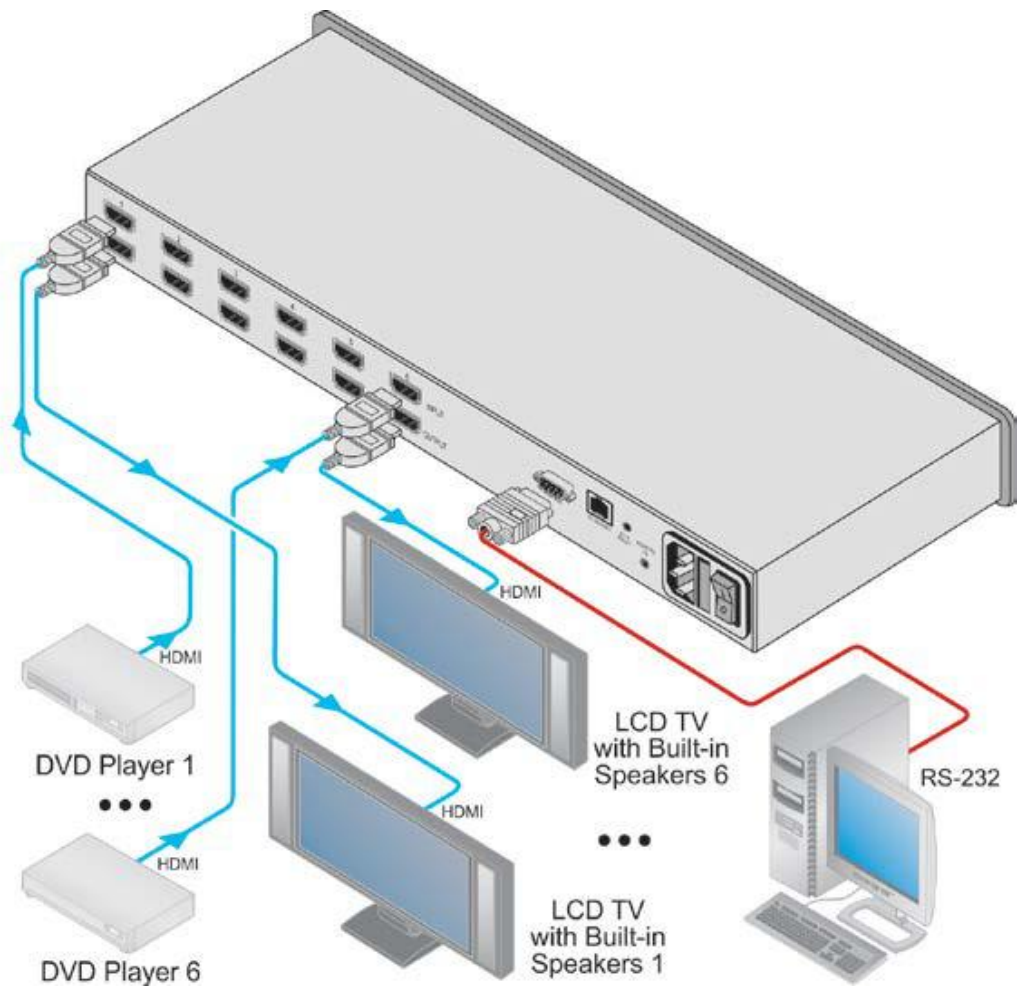

Figure 3: Connecting the VS-66HN 6x6 HDMI Matrix Switcher

6 Operating the VS-66HN 6x6 HDMI Matrix Switcher

This section describes:

- Switching an input to an output (see [Section 6.1](#))
- Acquiring the EDID (see [Section 6.2](#))
- Storing and recalling switch settings (see [Section 6.3](#))
- Changing the port switching speed (see [Section 6.4](#))
- Set HDCP on or off (see [Section 6.5](#))
- Resetting the **VS-66HN** IP parameters (see [Section 6.6](#))
- Switching Between Protocol 2000 and Protocol 3000 (see [Section 6.7](#))
- Connecting to the **VS-66HN** via RS-232 (see [Section 6.8](#))
- Connecting to the **VS-66HN** via Ethernet (see [Section 6.9](#))
- Upgrading the Firmware (see [Section 6.10](#))

6.1 Switching an Input to an Output

To switch an input to an output:

- Press an output button followed by an input button to switch the selected input to the selected output

6.2 Acquiring the EDID

You can acquire the EDID from any of the following:

- One output set to one or more of the six inputs (see [Section 6.2.1](#))
- Different outputs set to different inputs (see [Section 6.2.2](#))
- The default EDID (see [Section 6.2.3](#))

Note: Attempting to acquire the EDID from an output that does not have a display device connected to it results in the default EDID being acquired.

6.2.1 Acquiring the EDID from One Output

Note: You can assign the EDID from one output to any or all of the six inputs.

To acquire the EDID from a display device connected to one of the outputs:

1. Press the EDID and STO buttons simultaneously and hold them for 3 seconds.
Both buttons flash.
2. Press the input button to which the EDID is copied.
The selected input number flashes on the display.
3. Select the output from which the EDID is to be acquired.
4. Press the EDID button.
The EDID is stored when the display returns to normal and the EDID and STO buttons stop flashing.

6.2.2 Acquiring the EDID from Different Outputs to Different Inputs

To acquire the EDID from several outputs (for example, OUT 1 to IN 1 and OUT 6 to IN 3):

1. Connect the display devices to the outputs from which you want to acquire the EDIDs.
2. Press the EDID and STO buttons simultaneously and hold them for 3 seconds.
Both buttons flash.
3. Press the input button to which the EDID is copied (for example, IN 1).
The selected input number flashes on the display.
4. Select the output from which the EDID is acquired (for example, OUT 1).
5. Press the IN 1 button.
The IN 1 button stops flashing.
6. Press the next input button to which the EDID is copied (for example, IN 3).
The selected input number flashes on the display.

7. Select the output from which the EDID is acquired (for example, OUT 6).
8. Press the IN 3 button.
The IN 3 button stops flashing.
9. Press the input buttons to which you want to copy the EDID (for example, IN 1 and IN 3).
10. Make sure that the relevant input numbers flash on the display.
11. Press the EDID button.
The process is complete when the display returns to normal.

6.2.3 Acquiring the Default EDID

To store the default EDID on a selected input (for example, Input 2):

1. Press the EDID and STO buttons simultaneously and hold them for 3 seconds.
Both buttons flash.
2. Press the input (for example, Input 2) to which the EDID is to be copied.
The selected input number flashes on the display.
3. Press the OFF button until "0" (zero) appears on the display.
4. Press the EDID button.
The default EDID is stored on the selected input when the display returns to normal.

6.3 Storing and Recalling a Preset

You can use the STO and RCL buttons to store up to 12 setups and then recall them using the OUT (1-6) and IN (7-12) SELECTOR buttons (see [Figure 4](#)).

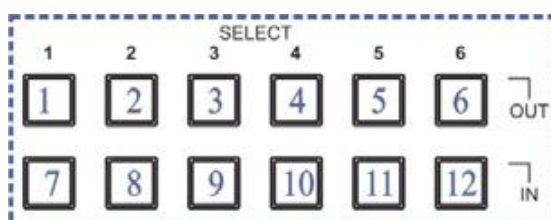

Figure 4: Store-Recall Button Configuration

To store a preset (for example, to preset 10):

1. Configure the switching as required for the preset.
2. Press the STO button.
The STO button flashes.
3. Select an OUT or IN SELECT button to store the device setting (for example, IN 4 for preset 10).
4. Press the STO button to store the current setup.
You have to press the STO button within 10 seconds or the procedure automatically times out.

To recall a preset (for example, preset 10):

1. Press the RCL button.
The RCL button flashes.
2. Press the relevant OUT or IN button that stored the preset (for example, IN 4/preset 10).
3. Press the RCL button to recall the stored preset.
The RCL button stops flashing.

6.4 Changing the Port Switching Speed

The switching speed can be set per port to any of the following:

- 3—Normal (default)
- 2—Fast
- 1—Extra fast

To change the port switching speed:

1. Ensure that the device is in normal switching mode, (that is, not Store, Recall or EDID mode).
2. Press the RCL and EDID buttons at the same time.
The RCL and EDID buttons flash, and the display indicates the switching speed mode of each port.
IN 1, IN 2 and IN 3 are illuminated (red).

3. Press one or more (or ALL) of the OUT buttons to select the port to change.
The selected port setting on the LED display flashes.
4. Press one of the IN 1/IN 2/IN 3 button to toggle the switching speed, (to Extra fast/Fast/Normal, respectively).
The switching speed displayed changes for the selected ports.
5. Press the LOCK button to confirm the change.
The switching speed for the selected port is changed and the device reverts to the normal switching mode.

Note: If the LOCK button is not pressed within about 12 seconds, the device exits the port speed switching mode automatically and all changes are lost.

6.5 Setting HDCP to On/Off

HDCP support can be enabled (On) or disabled (Off) for each of the HDMI inputs, allowing the source to transmit a non-HDCP signal if required (for example, when working with a Mac computer)

To set the HDCP:

1. Turn the power off on the machine.
2. Press and hold the IN 1, IN 2 and LOCK buttons simultaneously and turn the power on while pressing these buttons (you will need more than one person to perform this step).

The machine is set to the HDCP enable/disable mode.

The input front panel buttons' status indicates the HDCP state of each input:

- HDCP enabled (ON) on an input – that input button is illuminated
 - HDCP disabled (OFF) on an input – that button is not illuminated
3. Press an input button to change its status.
You can press one or more inputs.

4. Once you have changed the status of HDCP on the inputs as desired, press the EDID to save the changes and exit the HDCP enable/disable mode to return to normal operation.

Note: If the EDID button is not pressed within about 12 seconds, the device exits the port speed switching mode automatically and all changes are lost.

6.6 Resetting the IP Parameters



This procedure resets only the IP related parameters. All switching and preset values remain unchanged.

To reset the IP parameters to their default values (see [Section 8](#)):

- Press and hold the ETH Reset button on the rear panel while powering up the device

6.7 Switching Between Protocol 2000 and Protocol 3000

To switch from Protocol 2000 to Protocol 3000 and vice-versa using the front panel buttons:

- Press Output buttons 1 and 3 at the same time.
Protocol 3000 is active.
- Press Output buttons 1 and 2 at the same time.
Protocol 2000 is active.



Note that when sending consecutive protocol commands make sure to maintain at least a 200ms delay between commands.

After performing EDID get/store commands, a 1 sec delay is required before sending another protocol command.

6.8 Connecting via RS-232

You can connect to the **VS-66HN** via an RS-232 connection using, for example, a PC. Note that a null-modem adapter/connection is not required.

To connect to the product via RS-232:

- Connect the RS-232 9-pin D-sub on the rear panel of the **VS-66HN** via a 9-wire straight cable (only pin 2 to pin 2, pin 3 to pin 3, and pin 5 to pin 5 need to be connected) to the RS-232 9-pin D-sub port on your PC

6.9 Connecting via Ethernet

You can connect to the **VS-66HN** via Ethernet using either of the following methods:

- Directly to the PC using a crossover cable (see [Section 6.9.1](#))
- Via a network hub, switch, or router, using a straight-through cable (see [Section 6.9.2](#))

After connecting the **VS-66HN** to the Ethernet port, configure your local Ethernet port by following the instructions in the Ethernet Configuration (K-LanConfigurator) guide available from www.kramerav.com/support/product_downloads.asp or from the Downloads section of the **VS-66HN** Web page.

Note: If you want to connect via a router and your IT system is based on IPv6, speak to your IT department for specific installation instructions.

6.9.1 Connecting the Ethernet Port Directly to a PC

You can connect the Ethernet port of the **VS-66HN** directly to the Ethernet port on your PC using a crossover cable with RJ-45 connectors.



This type of connection is recommended for identifying the **VS-66HN** with the factory configured default IP address.

6.9.2 Connecting the Ethernet Port via a Network Hub or Switch

You can connect the Ethernet port of the **VS-66HN** to the Ethernet port on a network hub or using a straight-through cable with RJ-45 connectors.

6.10 Upgrading the Firmware

For instructions on upgrading the firmware see “*Upgrading the VS-66HN Firmware Using the STC Software*”.

7 Technical Specifications

INPUTS:	6 HDMI connectors
OUTPUTS:	6 HDMI connectors
BANDWIDTH:	Up to 6.75Gbps data rate (2.25Gbps per graphics channel)
COMPLIANCE WITH HDMI STANDARD:	HDMI and HDCP
RESOLUTION:	Up to UXGA; 1080p
POWER CONSUMPTION:	100–240V AC, 50/60Hz, 40VA
CONTROLS:	Front panel buttons, infrared remote control transmitter, RS-232, Ethernet
OPERATING TEMPERATURE:	0° to +40°C (32° to 104°F)
STORAGE TEMPERATURE:	-40° to +70°C (-40° to 158°F)
HUMIDITY:	10% to 90%, RHL non-condensing
DIMENSIONS:	19" x 7" x 1U (W, D, H)
WEIGHT:	2.3kg (5.07lbs) approx.
INCLUDED ACCESSORIES:	Power cord, IR transmitter, rack "ears"
OPTIONS:	External remote IR receiver cable
Specifications are subject to change without notice at www.kramerav.com	

8 Default Communication Parameters

RS-232			
Protocol 2000		Protocol 3000 (Default)	
Baud Rate	9600	Baud Rate	9600
Data Bits	8	Data Bits	8
Stop Bits	1	Stop Bits	1
Parity	None	Parity	None
Command Format	HEX	Command Format	ASCII
Example (Output 1 to Input 1)	0x01, 0x81, 0x81, 0x81	Example (Output 1 to Input 1)	#VID1>1<CR>

Switching Protocol			
P2000 → P3000		P3000 → P2000	
Command	0x38, 0x80, 0x83, 0x81	Command	#P2000<CR>
Front Panel	Press and hold Output 1 and Output 3 simultaneously	Front Panel	Press and hold Output 1 and Output 2 simultaneously

Ethernet			
IP Address	192.168.1.39	TCP Port	5000
Subnet Mask	255.255.255.0	UDP Port	50000

9 Default EDID

Monitor

Model name..... VS-66HN
Manufacturer..... KMR
Plug and Play ID..... KRM0200
Serial number..... 1
Manufacture date..... 2010, ISO week 24

EDID revision..... 1.3
Input signal type..... Digital (DVI)
Color bit depth..... Undefined
Display type..... RGB color
Screen size..... 700 x 390 mm (31.5 in)
Power management..... Not supported
Extension blocs..... 1 (CEA-EXT)

DDC/CI..... Not supported

Color characteristics

Default color space..... Non-sRGB
Display gamma..... 2.20
Red chromaticity..... Rx 0.640 - Ry 0.341
Green chromaticity..... Gx 0.286 - Gy 0.610
Blue chromaticity..... Bx 0.146 - By 0.069
White point (default).... Wx 0.284 - Wy 0.293
Additional descriptors... None

Timing characteristics

Horizontal scan range.... 31-94kHz
Vertical scan range..... 50-85Hz
Video bandwidth..... 170MHz
CVT standard..... Not supported
GTF standard..... Not supported
Additional descriptors... None
Preferred timing..... Yes
Native/preferred timing.. 1280x720p at 60Hz
 Modeline..... "1280x720" 74.250 1280 1390 1430 1650 720 725 730 746 +hsync -vsync
Detailed timing #1..... 1920x1080p at 60Hz (16:9)
 Modeline..... "1920x1080" 148.500 1920 2008 2052 2200 1080 1084 1089 1125 +hsync +vsync

Standard timings supported

720 x 400p at 70Hz - IBM VGA
720 x 400p at 88Hz - IBM XGA2
640 x 480p at 60Hz - IBM VGA
640 x 480p at 67Hz - Apple Mac II
640 x 480p at 72Hz - VESA
640 x 480p at 75Hz - VESA
800 x 600p at 56Hz - VESA
800 x 600p at 60Hz - VESA
800 x 600p at 72Hz - VESA
800 x 600p at 75Hz - VESA
832 x 624p at 75Hz - Apple Mac II
1024 x 768i at 87Hz - IBM

1024 x 768p at 60Hz - VESA
1024 x 768p at 70Hz - VESA
1024 x 768p at 75Hz - VESA
1280 x 1024p at 75Hz - VESA
1152 x 870p at 75Hz - Apple Mac II
1280 x 720p at 60Hz - VESA STD
1280 x 800p at 60Hz - VESA STD
1440 x 900p at 60Hz - VESA STD
1280 x 960p at 60Hz - VESA STD
1280 x 1024p at 60Hz - VESA STD
1400 x 1050p at 60Hz - VESA STD
1680 x 1050p at 60Hz - VESA STD
1600 x 1200p at 60Hz - VESA STD

EIA/CEA-861 Information

Revision number..... 3
IT underscan..... Not supported
Basic audio..... Supported
YCbCr 4:4:4..... Not supported
YCbCr 4:2:2..... Not supported
Native formats..... 1
Detailed timing #1..... 720x480p at 60Hz (4:3)
 Modeline..... "720x480" 27.000 720 736 798 858 480 489 495 525 -hsync -vsync
Detailed timing #2..... 1920x1080i at 60Hz (16:9)
 Modeline..... "1920x1080" 74.250 1920 2008 2052 2200 1080 1084 1094 1124 interlace +hsync
+vsync
Detailed timing #3..... 1920x1080i at 50Hz (16:9)
 Modeline..... "1920x1080" 74.250 1920 2448 2492 2640 1080 1084 1094 1124 interlace +hsync
+vsync
Detailed timing #4..... 1280x720p at 60Hz (16:9)
 Modeline..... "1280x720" 74.250 1280 1390 1430 1650 720 725 730 750 +hsync +vsync
Detailed timing #5..... 1280x720p at 50Hz (16:9)
 Modeline..... "1280x720" 74.250 1280 1720 1760 1980 720 725 730 750 +hsync +vsync

CE video identifiers (VICs) - timing/formats supported

720 x 576p at 50Hz - EDTV (4:3, 16:15)
1280 x 720p at 50Hz - HDTV (16:9, 1:1)
1920 x 1080i at 60Hz - HDTV (16:9, 1:1)
1920 x 1080i at 50Hz - HDTV (16:9, 1:1)
1280 x 720p at 60Hz - HDTV (16:9, 1:1) [Native]
1920 x 1080p at 60Hz - HDTV (16:9, 1:1)
1920 x 1080p at 50Hz - HDTV (16:9, 1:1)
NB: NTSC refresh rate = (Hz*1000)/1001

CE audio data (formats supported)

LPCM 3-channel, 24-bits at 44/48 kHz

CE speaker allocation data

Channel configuration.... 7.1
Front left/right..... Yes
Front LFE..... No
Front center..... Yes
Rear left/right..... No
Rear center..... No
Front left/right center.. No
Rear left/right center... No

Rear LFE..... No

CE vendor specific data (VSDB)

IEEE registration number. 0x000C03

CEC physical address..... 1.0.0.0

Maximum TMDS clock..... 165MHz

Report information

Date generated..... 08/03/2011

Software revision..... 2.52.0.857

Data source..... Real-time 0x0031

Operating system..... 5.1.2600.2.Service Pack 3

10 Kramer Protocol 2000

The Kramer Protocol 2000 RS-232/RS-485 communication uses four bytes of information as defined below. All the values in the table are decimal, unless otherwise stated.

MSB								LSB
1st Byte	DESTINATION	INSTRUCTION						
0	D	N5	N4	N3	N2	N1	N0	
7	6	5	4	3	2	1	0	
2nd Byte	INPUT							
1	I6	I5	I4	I3	I2	I1	I0	
7	6	5	4	3	2	1	0	
3rd Byte	OUTPUT							
1	O6	O5	O4	O3	O2	O1	O0	
7	6	5	4	3	2	1	0	
4th Byte	MACHINE NUMBER							
1	OVR	X	M4	M3	M2	M1	M0	
7	6	5	4	3	2	1	0	

1st Byte: Bit 7 – Defined as 0
 D – DESTINATION:
 0 – Sends information to the switchers (from the PC)
 1 – Sends information to the PC (from the switcher)
 N5...N0 – INSTRUCTION

The 6-bit INSTRUCTION defines the function performed by the switcher(s). If a function is performed using the machine's keyboard, these bits are set with the INSTRUCTION NO. performed. The instruction codes are defined according to the table below (INSTRUCTION NO. is the value set in N5...N0).

2nd Byte: Bit 7 – Defined as 1
 I6...I0 – INPUT

When switching (i.e. instruction codes 1 and 2), the 7-bit INPUT is set as the input number to be switched. If switching is done using the machine's front panel, these bits are set with the INPUT NUMBER switched. For other operations, these bits are defined according to the table.

3rd Byte: Bit 7 – Defined as 1
 O6...O0 – OUTPUT

When switching (i.e. instruction codes 1 and 2), the 7-bit OUTPUT is set as the output number to be switched. If switching is done using the machine's front panel, these bits are set with the OUTPUT NUMBER switched. For other operations, these bits are defined according to the table.

4th Byte: Bit 7 – Defined as 1
 Bit 5 – Don't care
 OVR – Machine number override
 M4...M0 – MACHINE NUMBER

This byte is used to address machines in a system by their machine numbers. When several machines are controlled from a single serial port, they are usually configured together and each machine has an individual machine number. If the OVR bit is set, then all machine numbers accept (implement) the command and the addressed machine replies. When a single machine is controlled over the serial port, always set M4...M0 to 1, and make sure that the machine itself is configured as MACHINE NUMBER = 1.

Instruction Codes for Protocol 2000				
Instruction		Definition for Specific Instruction		Notes
#	Description	Input	Output	
0	RESET VIDEO	0	0	1
1	SWITCH VIDEO	Set equal to video input which is to be switched (0 = disconnect)	Set equal to video output which is to be switched (0 = to all the outputs)	2, 15
3	STORE VIDEO STATUS	Set as SETUP #	0 - to store 1 - to delete	2, 3, 15
4	RECALL VIDEO STATUS	Set as SETUP #	0	2, 3, 15
5	REQUEST STATUS OF A VIDEO OUTPUT	Set as SETUP #	Equal to output number whose status is reqd	4, 3
15	REQUEST WHETHER SETUP IS DEFINED / VALID INPUT IS DETECTED	SETUP # or Input #	0 - for checking if setup is defined 1 - for checking if input is valid	8
30	LOCK FRONT PANEL	0 - Panel unlocked 1 - Panel locked	0	2
31	REQUEST WHETHER PANEL IS LOCKED	0	0	16
56	CHANGE TO ASCII	0	Kramer protocol 3000	19
61	IDENTIFY MACHINE	1 - video machine name 2 - audio machine name 3 - video software version 4 - audio software version 5 - RS422 controller name 6 - RS422 controller version 7 - remote control name 8 - remote software version 9 - Protocol 2000 revision	0 - Request first 4 digits 1 - Request first suffix 2 - Request second suffix 3 - Request third suffix 10 - Request first prefix 11 - Request second prefix 12 - Request third prefix	13
62	DEFINE MACHINE	1 - number of inputs 2 - number of outputs 3 - number of setups	1 - for video 2 - for audio 3 - for SDI 4 - for remote panel 5 - for RS-422 controller	14

NOTES on the above table:

NOTE 1 - When the master switcher is reset, (e.g. when it is turned on), the reset code is sent to the PC. If this code is sent to the switchers, it resets according to the present power-down settings.

NOTE 2 - These are bi-directional definitions. That is, if the switcher receives the code, it performs the instruction; and if the instruction is performed (due to a keystroke operation on the front panel), then these codes are sent. For example, if the HEX code

01 85 88 83

was sent from the PC, then the switcher (machine 3) switches input 5 to output 8. If the user switched input 1 to output 7 via the front panel keypad, then the switcher sends HEX codes:

41 81 87 83

to the PC.

When the PC sends one of the commands in this group to the switcher, then, if the instruction is valid, the switcher replies by sending to the PC the same four bytes that it was sent (except for the first byte, where the DESTINATION bit is set high).

NOTE 3 - SETUP # 0 is the present setting. SETUP # 1 and higher are the settings saved in the switcher's memory, (i.e. those used for Store and Recall).

NOTE 4 - The reply to a "REQUEST" instruction is as follows: the same instruction and INPUT codes as were sent are returned, and the OUTPUT is assigned the value of the requested parameter. The replies to instructions 10 and 11 are as per the definitions in instructions 7 and 8 respectively. For example, if the present status of machine number 5 is breakaway setting, then the reply to the HEX code

0B 80 80 85

would be HEX codes

4B 80 81 85

NOTE 8 - The reply is as in TYPE 3 above, except that here the OUTPUT is assigned with the value 0 if the setup is not defined / no valid input is detected; or 1 if it is defined / valid input is detected.

NOTE 13 - This is a request to identify the switcher/s in the system. If the OUTPUT is set as 0, and the INPUT is set as 1, 2, 5 or 7, the machine sends its name. The reply is the decimal value of the INPUT and OUTPUT. For example, for a 2216, the reply to the request to send the audio machine name would be (HEX codes):

7D 96 90 81 (i.e. 128dec+ 22dec for 2nd byte, and 128dec+ 16dec for 3rd byte).

If the request for identification is sent with the INPUT set as 3 or 4, the appropriate machine sends its software version number. Again, the reply would be the decimal value of the INPUT and OUTPUT - the INPUT representing the number in front of the decimal point, and the OUTPUT representing the number after it. For example, for version 3.5, the reply to the request to send the version number would be (HEX codes):

7D 83 85 81 (i.e. 128dec+ 3dec for 2nd byte, 128dec+ 5dec for 3rd byte).

If the OUTPUT is set as 1, then the ASCII coding of the lettering following the machine's name is sent. For example, for the VS-7588YC, the reply to the request to send the first suffix would be (HEX codes):

7D D9 C3 81 (i.e. 128dec+ ASCII for "Y"; 128dec+ ASCII for "C").

NOTE 14 - The number of inputs and outputs refers to the specific machine which is being addressed, not to the system. For example, if six 16X16 matrices are configured to make a 48X32 system (48 inputs, 32 outputs), the reply to the HEX code

3E 82 81 82 (ie. request the number of outputs)

would be HEX codes

7E 82 90 82

ie. 16 outputs

NOTE 15 – When the OVR bit (4th byte) is set, then the "video" commands have universal meaning. For example, instruction 1 (SWITCH VIDEO) causes all units (including audio, data, etc.) to switch. Similarly, if a machine is in "FOLLOW" mode, it performs any "video" instruction.

NOTE 16 - The reply to the "REQUEST WHETHER PANEL IS LOCKED" is as in NOTE 4 above, except that here the OUTPUT is assigned with the value 0 if the panel is unlocked, or 1 if it is locked.

NOTE 19 - After this instruction is sent, the unit will respond to the ASCII command set defined by the OUTPUT byte. The ASCII command to operate with the HEX command set must be sent in order to return to working with HEX codes.

11 Protocol 3000

By default, the **VS-66HN** is set to Protocol 3000 but is also compatible with Kramer's Protocol 2000 (see [Section 10](#)).



Note that the **VS-66HN** needs to be set to Protocol 2000 in order to use the IR remote control transmitter.

[Section 8](#) describes how to switch between Protocol 3000 and Protocol 2000.

The **VS-66HN** can be operated using serial commands from a PC, remote controller or touch screen using the Kramer Protocol 3000. However, when used in conjunction with the IR remote controller, these serial commands must also be in Protocol 2000 format.

This section describes:

- Kramer Protocol 3000 syntax (see [Section 11.1](#))
- Kramer Protocol 3000 commands (see [Section 11.2](#))

11.1 Kramer Protocol 3000 Syntax

11.1.1 Host Message Format

Start	Address (optional)	Body	Delimiter
#	<i>device_id@</i>	Message	CR

11.1.1.1 Simple Command

Command string with only one command without addressing:

Start	Body	Delimiter
#	Command SP <i>Parameter_1,Parameter_2,...</i>	CR

11.1.1.2 Command String

Formal syntax with commands concatenation and addressing:

Start	Address	Body	Delimiter
#	<i>device_id@</i>	Command_1 <i>Parameter1_1,Parameter1_2,... </i> Command_2 <i>Parameter2_1,Parameter2_2,... </i> Command_3 <i>Parameter3_1,Parameter3_2,... ...</i>	CR

11.1.2 Device Message Format

Start	Address (optional)	Body	delimiter
~	<i>Sender_id@</i>	Message	CR LF

11.1.2.1 Device Long Response

Echoing command:

Start	Address (optional)	Body	Delimiter
~	<i>device_id@</i>	Command SP [<i>Param1 ,Param2 ...</i>] result	CR LF

CR = Carriage return (ASCII 13 = 0x0D)

LF = Line feed (ASCII 10 = 0x0A)

SP = Space (ASCII 32 = 0x20)

11.1.3 Command Terms

Command

A sequence of ASCII letters ('A'-'Z', 'a'-'z' and '-').

Command and parameters must be separated by at least one space.

Parameters

A sequence of alphanumeric ASCII characters ('0'-'9', 'A'-'Z', 'a'-'z' and some special characters for specific commands). Parameters are separated by commas.

Message string

Every command entered as part of a message string begins with a **message starting character** and ends with a **message closing character**.

Note: A string can contain more than one command. Commands are separated by a pipe ('|') character.

Message starting character

'#' – For host command/query

'~' – For device response

Device address (Optional, for K-NET)

K-NET Device ID followed by '@'

Query sign

'?' follows some commands to define a query request.

Message closing character

CR – For host messages; carriage return (ASCII 13)

CRLF – For device messages; carriage return (ASCII 13) + line-feed (ASCII 10)

Command chain separator character

When a message string contains more than one command, a pipe ('|') character separates each command.

Spaces between parameters or command terms are ignored.

11.1.4 Entering Commands

You can directly enter all commands using a terminal with ASCII communications software, such as HyperTerminal, Hercules, etc. Connect the terminal to the serial or Ethernet port on the Kramer device. To enter **CR** press the Enter key. (**LF** is also sent but is ignored by command parser).

For commands sent from some non-Kramer controllers like Crestron, some characters require special coding (such as, /X##). Refer to the controller manual.

11.1.5 Command Forms

Some commands have short name syntax in addition to long name syntax to allow faster typing. The response is always in long syntax.

11.1.6 Chaining Commands

Multiple commands can be chained in the same string. Each command is delimited by a pipe character ("|"). When chaining commands, enter the **message starting character** and the **message closing character** only once, at the beginning of the string and at the end.

Commands in the string do not execute until the closing character is entered.

A separate response is sent for every command in the chain.

11.1.7 Maximum String Length

64 characters

11.2 Kramer Protocol 3000 Commands

Command	Short Form	Description	Permission
#		Protocol handshaking	End User
BUILD-DATE?		Read device build date	End User
CPEDID		Copy EDID data from the output to the input EEPROM	End User
DISPLAY?		Read if output is valid	End User
FACTORY		Reset to factory default configuration	
GEDID		Read EDID data	User SW Internal
GEDID-EXT		Read EDID data from external device connected to output	User SW Internal
HELP		List of commands	End User
IDV		Visual identify device	End User
INFO-IO?		Read in/out count	End User
INFO-PRST?		Read maximum preset count	End User
LDEDID		Load EDID data	User SW Internal
LOCK-FP	LCK	Lock front panel	Administrator
LOCK-FP?	LCK?	Read lock front panel	End User
MODEL?		Read device model	End User
P2000		Switch to protocol 2000	End User
PROT-VER?		Read device protocol version	End User
PRST-LST?		Read saved presets list	End User
PRST-RCL		Recall saved preset	End User
PRST-STO		Store current connections to preset	End User
PRST-VID?		Read video connections from saved preset	End User
RESET		Reset device	Administrator
SIGNAL?		Read if input is valid	End User
SN?		Read device serial number	End User
VERSION?		Read device firmware version	End User
VID		Switch video only	End User
VID?		Get video switch state	End User

11.3 Kramer Protocol 3000 – Detailed Commands

This section describes the detailed commands list.

Command - BUILD-DATE		Command Type - System-mandatory	
Command Name		Permission	Transparency
Set:	-	-	-
Get:	BUILD-DATE?	End User	Public
Description		Syntax	
Set:	Get device build date	# BUILD-DATE _{CR}	
Get:	-	-	
Response			
~ _{nn} @ BUILD-DATE _{SP} <i>date</i> _{SP} <i>time</i> _{CR LF}			
Parameters			
<i>date</i> - Format: YYYY/MM/DD where YYYY = Year, MM = Month, DD = Day			
<i>time</i> - Format: hh:mm:ss where hh = hours, mm = minutes, ss = seconds			

Command - CPEDID		Command Type - System	
Command Name		Permission	Transparency
Set:	CPEDID	End User	Public
Get:	-	-	-
Description		Syntax	
Set:	Copy EDID data from the output to the input EEPROM	# CPEDID _{SP} <i>output_id,input_id</i> _{CR}	
Get:	-	-	
Response			
~ _{nn} @ CPEDID _{SP} <i>output_id,input_id</i> _{CR LF}			
Parameters			
<i>output_id</i> – Video output id: 1 (HDMI OUTPUT 1) ... 6 (HDMI OUTPUT 6)			
<i>input_id</i> – Video input id: 1 (HDMI INPUT 1) ... 6 (HDMI INPUT 6)			
K-Config Example			
Copy the EDID data from HDMI OUTPUT 5 (EDID source) to HDMI INPUT 2: "#CPEDID 5,2",0x0D (K-Config command format) "#CPEDID 5,2"<CR> (Hercules command format)			

Command - DISPLAY?		Command Type - System	
Command Name		Permission	Transparency
Set:	-	-	-
Get	DISPLAY?	End User	Public
Description		Syntax	
Set:	-	-	
Get:	Get output HPD status	# DISPLAY? _{SP} <i>out_id</i> _{CR}	
Response			
~ _{nn} @ DISPLAY _{SP} <i>out_id,status</i> _{CR LF}			
Parameters			
<i>out_id</i> - output number <i>status</i> - HPD status according to signal validation – 0: Signal or sink is not valid, 1: Signal or sink is valid, 2: Sink and EDID is valid			
Response Triggers			
After execution, response is sent to the com port from which the Get was received Response is sent after every change in output HPD status ON to OFF Response is sent after every change in output HPD status OFF to ON and ALL parameters (new EDID, etc.) are stable and valid			

Command – FACTORY		Command Type – System-mandatory	
Command Name		Permission	Transparency
Set:	FACTORY	End User	-
Get:	-	-	-
Description		Syntax	
Set:	Reset device to factory defaults configuration	# FACTORY _{CR}	
Get :	-	-	
Response			
~ _{nn} @ BUILD-DATE _{SP} <i>date</i> _{SP} <i>time</i> _{CR LF}			
Notes			
This command deletes all user data from the device. The deletion can take some time.			

Command - GEDID		Command Type - System	
Command Name		Permission	Transparency
Set:	GEDID	Administrator	Public
Get:	GEDID?	End User	Public
Description		Syntax	
Set:	Set EDID data from device	# GEDID _{SP} stage, stage_id _{CR}	
Get:	Get EDID support on certain input/output	# GEDID? _{SP} stage, stage_id _{CR}	
Response			
Set: Multi-line response: ~nn@ GEDID _{SP} stage,stage_id,size _{CR LF} EDID_data _{CR LF} ~nn@ GEDID _{SP} stage,stage_id _{SP} OK _{CR LF}			
Get: ~nn@ GEDID _{SP} stage,stage_id,size _{CR LF}			
Parameters			
stage - input/output – 0: input, 1:output, 2: default EDID stage_id - number of chosen stage (1.. max number of inputs/outputs) size - EDID data size. For Set, size of data to be sent from device, for Get, 0 means no EDID support			
Response Triggers			
Response is sent to the com port from which the Set (before execution) / Get command was received			
Notes			
For Get, size=0 means EDID is not supported For old devices that do not support this command, ~nn@ ERR 002 _{CR LF} is received			

Command - HELP		Command Type - System-mandatory	
Command Name		Permission	Transparency
Set:	-	-	-
Get:	HELP	End User	Public
Description		Syntax	
Set:	-	-	
Get:	Get command list or help for specific command	2 options: 1. # HELP _{CR} 2. # HELP _{SP} command_name _{CR}	
Response			
1. Multi-line: ~nn@ Device available protocol 3000 commands : _{CR LF} command _{SP} command... _{CR LF} To get help for command use: HELP (COMMAND_NAME) _{CR LF}			
2. Multi-line: ~nn@ HELP _{SP} command: _{CR LF} description _{CR LF} USAGE : usage _{CR LF}			

Command - IDV		Command Type - System	
Command Name		Permission	Transparency
Set:	IDV	End User	Public
Get:	-	-	-
Description		Syntax	
Set:	Set visual indication from device	#IDV _{CR}	
Get:	-	-	
Response			
~nn@IDV _{SP} OK _{CR LF}			
Notes			
Using this command, some devices can light a sequence of buttons or LEDs to allow identification of a specific device from similar devices			

Command - INFO-IO?		Command Type - System	
Command Name		Permission	Transparency
Set:	-	-	-
Get:	INFO-IO?	End User	Public
Description		Syntax	
Set:	-	-	
Get:	Get in/out count	#INFO-IO? _{CR}	
Response			
~nn@INFO-IO? _{SP} IN _{SP} inputs_count,OUT _{SP} outputs_count _{CR LF}			
Parameters			
<i>inputs_count</i> - number of inputs in the unit <i>outputs_count</i> - number of outputs in the unit			

Command - INFO-PRST?		Command Type - System	
Command Name		Permission	Transparency
Set:	-	-	-
Get:	INFO-PRST?	End User	Public
Description		Syntax	
Set:	-	-	
Get:	Get maximum preset count	#INFO-PRST? _{CR}	
Response			
~nn@INFO-PRST? _{SP} VID _{SP} preset_video_count,AUD _{SP} preset_audio_count _{CR LF}			
Parameters			
<i>preset_video_count</i> - maximum number of video presets in the unit <i>preset_audio_count</i> - maximum number of audio presets in the unit			
Notes			
In most units, video and audio presets with the same number are stored and recalled together by commands #PRST-STO and #PRST-RCL			

Command - LDEDID		Command Type - System	
Command Name		Permission	Transparency
Set:	LDEDID	End User	Public
Get:	-	-	-
Description		Syntax	
Set:	Write EDID data from external application to device	Multi-step syntax (see following steps)	
Get:	None	None	
Communication Steps (Command and Response)			
<p>Step 1: #LDEDID_[SP]<i>dst_type, dest_bitmask, size, safe_mode</i>_[CR]</p> <p>Response 1: ~<i>nn</i>@LDEDID_[SP]<i>dst_type, dest_bitmask, size, safe_mode</i>_[SP]READY_[CR LF] or ~<i>nn</i>@LDEDID_[SP]ERRnn_[CR LF]</p> <p>Step 2: If ready was received, send EDID_DATA</p> <p>Response 2: ~<i>nn</i>@LDEDID_[SP]<i>dst_type, dest_bitmask, size, safe_mode</i>_[SP]OK_[CR LF] or ~<i>nn</i>@LDEDID_[SP]ERRnn_[CR LF]</p>			
Parameters			
<p><i>dst_type</i> - EDID destination type (usually input) – 0=input, 1=output, 2=Default EDID</p> <p><i>dest_bitmask</i> - bitmap representing destination IDs. Format: 0x*****, where * is ASCII presentation of hex digit. The binary presentation of this number is a bit mask for destinations. Setting '1' means EDID data has to be copied to this destination</p> <p><i>size</i> - EDID data size</p> <p><i>safe_mode</i> - 0 - Device accepts the EDID as is without trying to adjust 1 - Device tries to adjust the EDID</p> <p>EDID_DATA - data in protocol packets (see Section 11.3.1)</p>			
Response Triggers			
Response is sent to the com port from which the Set (before execution)			
Notes			
<p>When the unit receives the LDEDID command it replies with READY and enters the special EDID packet wait mode. In this mode the unit can receive only packets and not regular protocol commands. If the unit does not receive correct packets for 30 seconds or is interrupted for more than 30 seconds before receiving all packets, it sends timeout error ~<i>nn</i>@LDEDID_[SP]ERR01_[CR LF] and returns to the regular protocol mode. If the unit received data that is not a correct packet, it sends the corresponding error and returns to the regular protocol mode.</p> <p>See Protocol Packet reference in Section 11.3.1</p>			

Command - LOCK-FP		Command Type - System	
Command Name		Permission	Transparency
Set:	LOCK-FP	End User	Public
Get:	LOCK-FP?	End User	Public
Description		Syntax	
Set:	Lock front panel	Option 1: # LOCK-FP _{SP} <i>lock_mode</i> _{CR} Option 2: # LOCK-FP _{SP} <i>device_id,lock_mode</i> _{CR}	
Get:	Get front panel lock state	Option 1: # LOCK-FP? _{CR} Option 2: # LOCK-FP? _{SP} <i>device_id</i> _{CR}	
Response			
Set: Option 1: ~ <i>nn</i> @ LOCK-FP _{SP} <i>lock_mode</i> _{SP} OK _{CR LF} Option 2: ~01@ LOCK-FP _{SP} <i>device_id,lock_mode</i> _{SP} OK _{CR LF}			
Get: Option 1: ~ <i>nn</i> @ LOCK-FP _{SP} <i>lock_mode</i> _{CR LF} Option 2: ~01@ LOCK-FP _{SP} <i>device_id, lock_mode</i> _{CR LF}			
Parameters			
<i>lock_mode</i> - 0/OFF - unlocks the front panel buttons, 1/ON - locks the front panel buttons <i>device_id</i> - for K-Net controllers, select the button panel to lock. Locking is allowed only from the master			

Command – MODEL?		Command Type – System-mandatory	
Command Name		Permission	Transparency
Set:	-	-	-
Get:	MODEL?	End User	-
Description		Syntax	
Set:	-	-	
Get :	Get device model	# MODEL? _{CR}	
Response			
~ <i>nn</i> @ MODEL _{SP} <i>model_name</i> _{CR LF}			
Parameters			
<i>model_name</i> – String of up to 19 printable ASCII chars			

Command - P2000		Command Type - System	
Command Name		Permission	Transparency
Set:	P2000	End User	Public
Get:	-	-	-
Description		Syntax	
Set:	Switch to protocol 2000	# P2000 <input type="checkbox"/> CR	
Get:	-	-	
Response			
~ <input type="checkbox"/> <input type="checkbox"/> @ P2000 <input type="checkbox"/> SP OK <input type="checkbox"/> CR LF			
Notes			
Available only for devices that support Protocol 2000 Protocol 2000 has a command to switch back to an ASCII protocol like Protocol 3000			

Command – PROT-VER?		Command Type – System-mandatory	
Command Name		Permission	Transparency
Set:	-	-	-
Get:	PROT-VER?	End User	-
Description		Syntax	
Set:	-	-	
Get :	Get protocol version	# PROT-VER? <input type="checkbox"/> CR	
Response			
~ <input type="checkbox"/> <input type="checkbox"/> @ PROT-VER <input type="checkbox"/> SP3000: <i>version</i> <input type="checkbox"/> CR LF			
Parameters			
<i>Version</i> – Format: XX.XX where X is a decimal digit			

Command - PROT-VER?		Command Type - System-mandatory	
Command Name		Permission	Transparency
Set:	-	-	-
Get:	PROT-VER?	End User	Public
Description		Syntax	
Set:	-	-	
Get:	Get device protocol version	# PROT-VER? <input type="checkbox"/> CR	
Response			
~ <input type="checkbox"/> <input type="checkbox"/> @ PROT-VER <input type="checkbox"/> SP3000: <i>version</i> <input type="checkbox"/> CR LF			
Parameters			
<i>Version</i> - XX.XX where X is a decimal digit			
Response Triggers			
Notes			

Command - PRST-LST?		Command Type - System	
Command Name		Permission	Transparency
Set:	-	-	-
Get:	PRST-LST?	End User	Public
Description		Syntax	
Set:	-	-	
Get:	Get saved preset list	# PRST-LST? _{CR}	
Response			
~ _{nn} @ PRST-LST _{SP} <i>preset, preset, ...</i> _{CR LF}			
Parameters			
<i>preset</i> - preset number			
Notes			
In most units, video and audio presets with the same number are stored and recalled together by commands #PRST-STO and #PRST-RCL			

Command - PRST-RCL		Command Type - System	
Command Name		Permission	Transparency
Set:	PRST-RCL	End User	Public
Get:	-	-	-
Description		Syntax	
Set:	Recall saved preset list	# PRST-RCL _{SP} <i>preset</i> _{CR}	
Get:	-	-	
Response			
~ _{nn} @ PRST-RCL _{SP} <i>preset</i> _{CR LF}			
Parameters			
<i>preset</i> - preset number			
Notes			
In most units, video and audio presets with the same number are stored and recalled together by commands #PRST-STO and #PRST-RCL			

Command - PRST-STO		Command Type - System	
Command Name		Permission	Transparency
Set:	PRST-STO	End User	Public
Get:	-	-	-
Description		Syntax	
Set:	Store current connections, volumes and modes in preset	#PRST-STO _{SP} preset _{CR}	
Get:	-	-	
Response			
~nn@PRST-STO _{SP} preset _{CR LF}			
Parameters			
preset - preset number			
Notes			
In most units, video and audio presets with the same number are stored and recalled together by commands #PRST-STO and #PRST-RCL			

Command - PRST-VID?		Command Type - System	
Command Name		Permission	Transparency
Set:	-	-	-
Get:	PRST-VID?	End User	Public
Description		Syntax	
Set:	-	-	
Get:	Get video connections from saved preset	#PRST-VID? _{SP} preset, out _{CR} #PRST-VID? _{SP} preset, * _{CR}	
Response			
~nn@PRST-VID _{SP} preset, in>out _{CR LF}			
~nn@PRST-VID _{SP} preset, in>1, in>2, in>3, ... _{CR LF}			
Parameters			
preset - preset number n - input number or '0' if output disconnected > - connection character between in and out parameters out - output number or '*' for all outputs			
Notes			
In most units, video and audio presets with the same number are stored and recalled together by commands #PRST-STO and #PRST-RCL			
Examples			
Store current audio and video connections, volumes and modes to preset 5	#PRST-STO 5 _{CR}	~PRST-STO 5 _{CR LF}	
Recall audio and video connections from preset 3	#PRCL 3 _{CR}	~PRST-RCL 3 _{CR LF}	
Show source of video output 2 from preset 3	#PRST-VID? 3,2 _{CR}	~PRST-VID 3, 4>2 _{CR LF}	

Command - RESET		Command Type - System-mandatory	
Command Name		Permission	Transparency
Set:	RESET	Administrator	Public
Get:	-	-	-
Description		Syntax	
Set:	Reset device	# RESET _{CR}	
Get:	-	-	
Response			
~ _{nn} @ RESET _{SP} OK _{CR LF}			
Notes			
To avoid locking the port due to a USB bug in Windows, disconnect USB connections immediately after running this command. If the port was locked, disconnect and reconnect the cable to reopen the port.			

Command - SIGNAL		Command Type - System	
Command Name		Permission	Transparency
Set:	-	-	-
Get:	SIGNAL?	End User	Public
Description		Syntax	
Set:	-	-	
Get:	Get input signal lock status	# SIGNAL? _{SP} <i>inp_id</i> _{CR}	
Response			
~ _{nn} @ SIGNAL _{SP} <i>inp_id,status</i> _{CR LF}			
Parameters			
<i>inp_id</i> - input number <i>status</i> - lock status according to signal validation – 0: Signal or sink is not valid, 1: Signal or sink is valid, 2: Sink and EDID is valid			
Response Triggers			
After execution, a response is sent to the com port from which the Get was received Response is sent after every change in input signal status ON to OFF, or OFF to ON			
Notes			

Command - SN?		Command Type - System-mandatory	
Command Name		Permission	Transparency
Set:	-	-	-
Get:	SN?	End User	Public
Description		Syntax	
Set:	-	-	
Get:	Get device serial number	# SN? _{CR}	
Response			
~ _{nn} @ SN _{SP} serial_number _{CR LF}			
Parameters			
serial_number - 11 decimal digits, factory assigned			
Response Triggers			
Notes			
For new products with 14 digit serial numbers, use only the last 11 digits			

Command - VERSION?		Command Type – System-mandatory	
Command Name		Permission	Transparency
Set:	-	-	-
Get:	VERSION?	End User	-
Description		Syntax	
Set:	-	-	
Get :	Get version number	# VERSION? _{CR}	
Response			
~ _{nn} @ VERSION _{SP} firmware_version _{CR LF}			
Parameters			
firmware_version – Format: XX.XX.XXXX where the digits group are: major.minor.build version			

Command - VID		Command Type - Switch	
Command Name		Permission	Transparency
Set:	VID	End User	Public
Get:	VID?	End User	Public
Description		Syntax	
Set:	Set video switch state	#VID _{SP} in>out, in>out,... _{CR}	
Get:	Get video switch state	#VID? _{SP} out _{CR} #VID? _{SP} * _{CR}	
Response			
Set: ~nn@VID _{SP} in>out _{CR LF} ~nn@VID _{SP} in>out _{CR LF} ... Get: ~nn@VID _{SP} in>out _{CR LF} ~nn@VID _{SP} in>1, in>2, ... _{CR LF}			
Parameters			
in - input number or '0' to disconnect output > - connection character between in and out parameters out - output number or '*' for all outputs			
Notes			
When AFV switching mode is active, this command also switches audio and the unit replies with command ~AV.			
Examples			
When AFV switching mode is active, this command also switches audio and the unit replies with command ~AV.			
Switch video and audio input 3 to output 7		#AV 3>7 _{CR}	~01@AV 3>7 _{CRLF}
Switch video input 2 to output 4		#V 2>4 _{CR}	~01@VID 2>4 _{CRLF}
Switch video input 4 to output 2 in machine 6		#6@VID 4>2 _{CR}	~06@VID 4>2 _{CRLF}
Disconnect video and audio output 4		#AV 0>4 _{CR}	~01@AV 0>4 _{CRLF}
Switch video input 3 to all outputs		#V 3>* _{CR}	~01@VID 3>* _{CRLF}
Chaining multiple commands	#AV 1>* V 3>4, 2>2, 2>1, 0>2 V 3>9 A 0>1 V? * _{CR} 1. Switch audio and video from input 1 to all outputs 2. Switch video input 3 to output 4, video input 2 to output 2, video input 2 to output 1 and disconnect video output 2 3. Switch video input 3 to output 9 (non-existent) 4. Disconnect audio output 1 5. Get status of all video links Command processing begins after entering _{CR} A response is sent for each command after processing		~AV 1>* _{CRLF} ~VID 3>4 _{CRLF} ~VID 2>2 _{CRLF} ~VID 2>1 _{CRLF} ~VID 0>2 _{CRLF} ~VID ERR003 _{CRLF} ~AUD 0>1 _{CRLF} ~VID 2>1, 0>2, 1>3, 3>4 _{CRLF}

11.3.1 Packet Protocol Structure

The packet protocol is designed to transfer large amounts of data, such as files, IR commands, EDID data, and so on.

11.3.1.1 Using the Packet Protocol

To use the packet protocol:

1. Send a command: LDEDID
2. Receive Ready or ERR###
3. If Ready:
 - Send a packet
 - Receive OK on the last packet
 - Receive OK for the command
4. Packet structure:
 - Packet ID (1, 2, 3...) (2 bytes in length)
 - Length (data length + 2 for CRC) - (2 bytes in length)
 - Data (data length -2 bytes)
 - CRC - 2 bytes

01	02	03	04	05...	
Packet ID	Length		Data		CRC

5. Response:

~NNNNSPOKCR LF

Where *NNNN* is the received packet ID in ASCII hex digits.

11.3.1.2 Calculating the CRC

The polynomial for the 16-bit CRC is:

CRC-CCITT: $0x1021 = x^{16} + x^{12} + x^5 + 1$

Initial value: 0000

Final XOR Value: 0

For a code example, see:

http://sanity-free.org/133/crc_16_ccitt_in_csharp.html

CRC example:

Data = "123456789"

Result => 0x31C3

LIMITED WARRANTY

The warranty obligations of Kramer Electronics for this product are limited to the terms set forth below:

What is Covered

This limited warranty covers defects in materials and workmanship in this product.

What is Not Covered

This limited warranty does not cover any damage, deterioration or malfunction resulting from any alteration, modification, improper or unreasonable use or maintenance, misuse, abuse, accident, neglect, exposure to excess moisture, fire, improper packing and shipping (such claims must be presented to the carrier), lightning, power surges, or other acts of nature. This limited warranty does not cover any damage, deterioration or malfunction resulting from the installation or removal of this product from any installation, any unauthorized tampering with this product, any repairs attempted by anyone unauthorized by Kramer Electronics to make such repairs, or any other cause which does not relate directly to a defect in materials and/or workmanship of this product. This limited warranty does not cover cartons, equipment enclosures, cables or accessories used in conjunction with this product.

Without limiting any other exclusion herein, Kramer Electronics does not warrant that the product covered hereby, including, without limitation, the technology and/or integrated circuit(s) included in the product, will not become obsolete or that such items are or will remain compatible with any other product or technology with which the product may be used.

How Long Does this Coverage Last

Seven years as of this printing; please check our Web site for the most current and accurate warranty information.

Who is Covered

Only the original purchaser of this product is covered under this limited warranty. This limited warranty is not transferable to subsequent purchasers or owners of this product.

What Kramer Electronics will do

Kramer Electronics will, at its sole option, provide one of the following three remedies to whatever extent it shall deem necessary to satisfy a proper claim under this limited warranty:

1. Elect to repair or facilitate the repair of any defective parts within a reasonable period of time, free of any charge for the necessary parts and labor to complete the repair and restore this product to its proper operating condition. Kramer Electronics will also pay the shipping costs necessary to return this product once the repair is complete.
2. Replace this product with a direct replacement or with a similar product deemed by Kramer Electronics to perform substantially the same function as the original product.
3. Issue a refund of the original purchase price less depreciation to be determined based on the age of the product at the time remedy is sought under this limited warranty.

What Kramer Electronics will not do Under This Limited Warranty

If this product is returned to Kramer Electronics or the authorized dealer from which it was purchased or any other party authorized to repair Kramer Electronics products, this product must be insured during shipment, with the insurance and shipping charges prepaid by you. If this product is returned uninsured, you assume all risks of loss or damage during shipment. Kramer Electronics will not be responsible for any costs related to the removal or re-installation of this product from or into any installation. Kramer Electronics will not be responsible for any costs related to any setting up this product, any adjustment of user controls or any programming required for a specific installation of this product.

How to Obtain a Remedy under this Limited Warranty

To obtain a remedy under this limited warranty, you must contact either the authorized Kramer Electronics reseller from whom you purchased this product or the Kramer Electronics office nearest you. For a list of authorized Kramer Electronics resellers and/or Kramer Electronics authorized service providers, please visit our web site at www.kramerelectronics.com or contact the Kramer Electronics office nearest you.

In order to pursue any remedy under this limited warranty, you must possess an original, dated receipt as proof of purchase from an authorized Kramer Electronics reseller. If this product is returned under this limited warranty, a return authorization number, obtained from Kramer Electronics, will be required. You may also be directed to an authorized reseller or a person authorized by Kramer Electronics to repair the product.

If it is decided that this product should be returned directly to Kramer Electronics, this product should be properly packed, preferably in the original carton, for shipping. Cartons not bearing a return authorization number will be refused.

Limitation on Liability

THE MAXIMUM LIABILITY OF KRAMER ELECTRONICS UNDER THIS LIMITED WARRANTY SHALL NOT EXCEED THE ACTUAL PURCHASE PRICE PAID FOR THE PRODUCT. TO THE MAXIMUM EXTENT PERMITTED BY LAW, KRAMER ELECTRONICS IS NOT RESPONSIBLE FOR DIRECT, SPECIAL, INCIDENTAL OR CONSEQUENTIAL DAMAGES RESULTING FROM ANY BREACH OF WARRANTY OR CONDITION, OR UNDER ANY OTHER LEGAL THEORY. Some countries, districts or states do not allow the exclusion or limitation of relief, special, incidental, consequential or indirect damages, or the limitation of liability to specified amounts, so the above limitations or exclusions may not apply to you.

Exclusive Remedy

TO THE MAXIMUM EXTENT PERMITTED BY LAW, THIS LIMITED WARRANTY AND THE REMEDIES SET FORTH ABOVE ARE EXCLUSIVE AND IN LIEU OF ALL OTHER WARRANTIES, REMEDIES AND CONDITIONS, WHETHER ORAL OR WRITTEN, EXPRESS OR IMPLIED. TO THE MAXIMUM EXTENT PERMITTED BY LAW, KRAMER ELECTRONICS SPECIFICALLY DISCLAIMS ANY AND ALL IMPLIED WARRANTIES, INCLUDING, WITHOUT LIMITATION, WARRANTIES OF MERCHANTABILITY AND FITNESS FOR A PARTICULAR PURPOSE. IF KRAMER ELECTRONICS CANNOT LAWFULLY DISCLAIM OR EXCLUDE IMPLIED WARRANTIES UNDER APPLICABLE LAW, THEN ALL IMPLIED WARRANTIES COVERING THIS PRODUCT, INCLUDING WARRANTIES OF MERCHANTABILITY AND FITNESS FOR A PARTICULAR PURPOSE, SHALL APPLY TO THIS PRODUCT AS PROVIDED UNDER APPLICABLE LAW.

IF ANY PRODUCT TO WHICH THIS LIMITED WARRANTY APPLIES IS A "CONSUMER PRODUCT" UNDER THE MAGNUSON-MOSS WARRANTY ACT (15 U.S.C.A. §2301, ET SEQ.) OR OTHER APPLICABLE LAW, THE FOREGOING DISCLAIMER OF IMPLIED WARRANTIES SHALL NOT APPLY TO YOU, AND ALL IMPLIED WARRANTIES ON THIS PRODUCT, INCLUDING WARRANTIES OF MERCHANTABILITY AND FITNESS FOR THE PARTICULAR PURPOSE, SHALL APPLY AS PROVIDED UNDER APPLICABLE LAW.

Other Conditions

This limited warranty gives you specific legal rights, and you may have other rights which vary from country to country or state to state.

This limited warranty is void if (i) the label bearing the serial number of this product has been removed or defaced, (ii) the product is not distributed by Kramer Electronics or (iii) this product is not purchased from an authorized Kramer Electronics reseller. If you are unsure whether a reseller is an authorized Kramer Electronics reseller, please visit our Web site at www.kramerelectronics.com or contact a Kramer Electronics office from the list at the end of this document.

Your rights under this limited warranty are not diminished if you do not complete and return the product registration form or complete and submit the online product registration form. Kramer Electronics thanks you for purchasing a Kramer Electronics product. We hope it will give you years of satisfaction.



For the latest information on our products and a list of Kramer distributors, visit our Web site where updates to this user manual may be found.

We welcome your questions, comments, and feedback.

Web site: www.kramerav.com

E-mail: info@kramerel.com



SAFETY WARNING

Disconnect the unit from the power supply before opening and servicing



P/N: 2900-300154

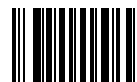

Rev: 11