

Pioneer

DJ SYSTEM

XDJ-R1

<http://pioneerdj.com/support/>

The Pioneer DJ support site shown above offers FAQs, information on software and various other types of information and services to allow you to use your product in greater comfort.

<http://rekordbox.com/>

For various types of information and services regarding rekordbox™, see the Pioneer website above.

Operating Instructions



Contents

How to read this manual

- In this manual, names of channels and buttons indicated on the product, names of menus in the software, etc., are indicated within square brackets ([]). (e.g. [CH 1], [CUE] button, [Start] menu)
- The Operating Instructions of rekordbox can be viewed from the rekordbox [Help] menu after installing rekordbox.

01 Before start

Features	3
----------------	---

02 Before you start

Mounting the smartphone stand	4
Supported sources	4
Usable media	4
Playable music file formats	5
Functions usable in combination with a computer.....	6

03 Connections

Connecting the input/output terminals.....	10
Connecting by wireless LAN.....	11

04 Part names and functions

Power & wireless section	14
USB device section.....	14
Player section.....	14
Browse section	17
Mixer section.....	18
Effect section.....	19

05 Operation

Turning the power on	21
To set to the standby mode	21
Loading and ejecting discs.....	21
Connecting and disconnecting USB devices	22
Playback	22
Using remotebox	22
Outputting sound	22
Mixing using the faders.....	23
Using the QUANTIZE function	23
Using the SYNC function	23

06 Changing the settings

About the auto standby function.....	24
Setting preferences	24
List of WLAN INFORMATION items.....	24
List of WLAN SETTING items	25

07 Using the DJ software

About the driver software (Windows)	26
Using the DJ software	27
Using VIRTUAL DJ LE.....	27
List of MIDI Messages.....	28

08 Additional information

Troubleshooting	35
Error messages	37
Block Diagram	37
List of icons displayed on the main unit display section.....	38
Cautions on use	38
Handling discs.....	38
About trademarks and registered trademarks	38

Before start

Features

This unit is an integrated DJ player/DJ mixer carrying over the high operability of the Pioneer DJ products used in clubs throughout the world. With it, full-fledged DJ performances can be held easily using tracks on USB devices, CDs and computers.

MULTI MEDIA, MULTI FORMAT

In addition to music CDs, music files stored on flash memory or other USB devices (MP3, AAC, WAV and AIFF) and music files stored on CD-R/RW discs (MP3, WAV and AIFF) can also be played. The unit can also be used as a DJ software controller and audio interface.

remotebox

This unit is equipped with a wireless LAN function. remotebox, a mobile device application available for download free of charge, can be used to control this unit remotely from a mobile device. Highly varied DJ performances can be achieved through operations on remotebox.

rekordbox

The included rekordbox (Mac/Windows) music management software can be used for the management (analysis, settings, creation, history storage) of music files on computers. Using music files managed with rekordbox in combination with this unit makes it possible to achieve outstanding DJ performances.

- In this manual, the Mac/Windows edition of rekordbox is referred to as "rekordbox".

USB EXPORT

rekordbox music files and management data can be exchanged using a USB device.

SOUND CARD

This unit is equipped with a MIDI interface allowing other brands of DJ software to be controlled. It also has a built-in sound card, allowing simple connections to other devices.

BEAT SYNC

This function can be used to automatically synchronize the tempo (BPM) and beat positions on the left and right decks based on the tracks' GRID information as analyzed with rekordbox. Genuine beat mixing is possible easily, without moving the [TEMPO] sliders.

QUANTIZE

This unit is equipped with a QUANTIZE function letting you set points on beat for tracks analyzed with rekordbox, even if buttons are pressed roughly. When setting auto loop beats and beat effects, the points are automatically set to the beat nearest the position at which the button was pressed.

With this unit, accurate, on-beat performances are possible without breaking the rhythm of the currently playing sound not only when auto beat loops and beat effects are set but also when using hot cues and other functions during playback.

AUTO BEAT LOOP

Loops can be set automatically without breaking the beat by pressing the [AUTO BEAT LOOP] control. The loop's number of beats can be changed by turning the [AUTO BEAT LOOP] control clockwise or counterclockwise.

BEAT FX

Beat effects are provided for each of the decks. Beat effects can be applied individually to the tracks currently playing on the respective deck.

SOUND COLOR FX

This unit is equipped with four effect buttons allowing the sound to be changed in various ways. The mood of the sound can be modified easily, simply by pressing a button and turning the control.

HOT CUE

This unit is equipped with a hot cue function for starting playback instantaneously from cue points that have been set in advance simply by pressing a button. Three hot cues can be set per deck.

4-BEAT SAMPLER

Sampled sound sources registered on this unit can be played simply by pressing a button. Sampled sound sources can be registered from tracks on USB devices and CDs.

3-BAND ISOLATOR

This unit is equipped with a 3-band equalizer allowing the volume of the high, medium and low frequency ranges to be adjusted separately. Not only can the tone be adjusted to your tastes, the sound for a certain range can be turned completely off by turning the control all the way counterclockwise (isolator function).

VIRTUAL DJ LE

A license key for "VIRTUAL DJ Limited Edition", a DJ software program with a complete set of basic functions for DJ performances, is included. This software can be downloaded from the Atomix productions website. Not only is this unit equipped with a wide variety of functions, including looping, effects, sampling, 4-channel mixing and video, it can also display Pioneer original design skins matching its operation panel.

Before you start

Mounting the smartphone stand

1 Insert the hooks in the smartphone stand into the holes in the main unit's rear panel and slide the stand downward until it stops.

- Do not mount any stand other than the included one.

2 Fasten the stand using the included screws.

- Do not use any screws other than the included ones.

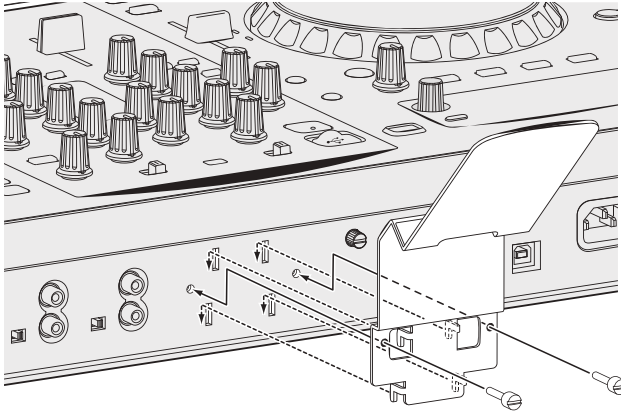

Cautions on using the smartphone stand

- This stand is exclusively for smartphones. Do not set tablets or other larger devices on it.
- Do not apply excessive force to the stand. Doing so may damage this unit.
- Please note that Pioneer will accept no responsibility whatsoever for damage to or malfunction of the device, injury, etc., due to the device falling, etc.

WARNING

Keep the included screws out of the reach of children and infants. If accidentally swallowed, contact a doctor immediately.

Supported sources

This unit supports the sources listed below.

- Discs (page 4)
- USB devices (page 5)

About the included CD-ROM

This unit can be used in combination with a computer when the software is installed onto the computer from the included CD-ROM.

The included CD-ROM contains the following two software programs.

- rekordbox music management software
- Driver software

Usable media

About discs

This unit can play the discs shown below.

Type	Mark ¹	Compatible formats	Supported file systems
CD		• Music CD (CD-DA)	—
CD-R		• Music CD (CD-DA)	ISO9660 level 1, ISO9660 level 2, Romeo and Joliet
CD-RW		• CD-ROM	—
CD-TEXT ²		• Music CD (CD-DA)	—

¹ Discs on which the marks on this table are indicated on the disc label, package or jacket can be played.

² Titles, album names and artist names recorded in the CD-Text data are displayed. When multiple text data are recorded on the disc, the information for the first text data is displayed.

❖ Discs that cannot be played

- DTS-CD
- Photo CDs
- Video CDs
- CD Graphics (CD-G) discs
- Unfinalized CDs
- DVD

❖ About CD-R/-RW discs

Music files (MP3/WAV/AIFF) recorded on CD-R/-RW discs can be played.

Folder layers	Max. 8 layers (files in folders beyond the 8th layer cannot be played)
Max. number of folders	999 folders
Max. number of files	999 files

When there are many folders or files, some time may be required for loading.

❖ Playback of discs created on a computer

Depending on the application's settings and the computer's environment settings, it may not be possible to play discs created on a computer. Record discs in a format playable on this unit. For details, contact your application's selling agent.

If the recording quality is poor due to the disc's properties, scratches or dirt on the disc or dirt on the recording lens, it may not be possible to play the disc.

See *Handling discs* on page 38 for instructions on handling discs.

❖ Creating backup discs

When CD-R/-RW discs are paused or left in the pause mode at cue points for long periods of time, it may become difficult to play the disc at that point, due to the properties of the disc. Also, when a specific point is looped repeatedly an extremely large number of times, it may become difficult to play that point.

When playing valuable discs, we recommend making backup discs.

❖ Regarding copy protected CDs

This unit is designed to CD standards. Operation and performance of discs with standards other than CD standards is not guaranteed.

❖ About playing DualDiscs

A DualDisc is a new two-sided disc, one side of which contains DVD content — video, audio, etc. — while the other side contains non-DVD content such as digital audio material.

The non-DVD, audio side of the disc is not compatible with this player. For more detailed information on the DualDisc specification, please refer to the disc manufacturer or disc retailer.

❖ About 8 cm discs

8 cm discs cannot be played. Do not mount 8 cm adapters on discs and play the discs on this unit. The adapter could come off while the disc is rotating, damaging both the disc and this unit.

❖ CD-TEXT

This unit is compatible with CD-TEXT. Titles, album names and artist names recorded in CD-TEXT are displayed. When multiple text data is recorded, the first text data is displayed. The supported character codes are listed below.

- ASCII
- ISO-8859-1

About USB devices

This unit supports USB mass storage class USB devices (external hard disks, portable flash memory devices, digital audio players, etc.).

Folder layers	Max. 8 layers (files in folders beyond the 8th layer cannot be played)
Max. number of folders	999 folders
Max. number of files	10 000 files (999 files for files not managed by rekordbox)
Supported file systems	FAT16 and FAT32 (HFS+ and NTFS are not supported.)

❖ USB devices that cannot be used

- Optical disc type devices such as external DVD/CD drives, etc., are not supported.
- USB hubs cannot be used.

❖ Cautions on using USB devices

- Some USB devices may not operate properly. Please note that Pioneer will accept no responsibility whatsoever for loss of data stored by the user on USB devices or other direct or indirect problems arising due to connection of USB devices to this unit.
- If a current larger than the allowable value is detected at this unit's USB device insertion slot, it may happen that the [USB STOP] indicator flashes, the supply of power to the USB device is stopped and communications are interrupted. To restore normal operation, disconnect the USB device from this unit. Avoid using USB devices for which excess currents have been detected. If normal operation is not restored using the method above (if communications cannot be established), turn this unit's power off then back on.
- If the USB device is split into multiple partitions, only the first partition can be used.
- USB devices equipped with flash card readers may not operate.
- Depending on the USB device you are using, the desired performance may not be achieved.

Playable music file formats

This unit supports music files in the formats shown below.

- AAC files on CD-ROMs cannot be played.
- Only up to 99 minutes of AAC files can be played.

Type	File extension	Compatible formats	Bit depth	Bit rate	Sampling frequency	Encoding method
MP3	.mp3	MPEG-1 AUDIO LAYER-3	16 bit	32 kbps to 320 kbps	32 kHz, 44.1 kHz, 48 kHz	CBR, VBR
		MPEG-2 AUDIO LAYER-3	16 bit	32 kbps to 160 kbps	16 kHz, 22.05 kHz, 24 kHz	CBR, VBR
AAC	.m4a, .aac and .mp4	MPEG-4 AAC LC	16 bit	16 kbps to 320 kbps	32 kHz, 44.1 kHz, 48 kHz	CBR, VBR
		MPEG-2 AAC LC	16 bit	16 kbps to 320 kbps	32 kHz, 44.1 kHz, 48 kHz	CBR, VBR
WAV	.wav	WAV	16 bit, 24 bit	—	44.1 kHz, 48 kHz	Uncompressed PCM
AIFF	.aif, .aiff	AIFF	16 bit, 24 bit	—	44.1 kHz, 48 kHz	Uncompressed PCM

About MP3 files

MP3 files include constant bit rate (CBR) and variable bit rate (VBR) files. Both types can be played on this unit, but the searching speed is slower for VBR files than for CBR files. To prioritize operability, we recommend recording files in CBR.

About AAC files

- AAC is the abbreviation of "Advanced Audio Coding", a basic format of audio compression technology used for MPEG-2 and MPEG-4.
- The file format and extension of AAC data depends on the application used to create the data.
- On this unit, in addition to AAC files encoded with iTunes® and with the extension ".m4a", files with the extensions ".aac" and ".mp4" files can also be played. However, AAC files that are copyright-protected, such as those purchased from the iTunes Store, cannot be played. Also, depending on the version of iTunes in which the file was encoded, it may not be possible to play the file.

About ID3 tags

The tag information types which can be registered from a music file are ID3 tags (v1, v1.1, v2.2.0, v2.3.0, and v2.4.0) or meta tags.

Functions usable in combination with a computer

About the included CD-ROM

This unit can be used in combination with a computer when the software is installed onto the computer from the included CD-ROM.

The included CD-ROM contains the following two software programs.

❖ rekordbox music management software

rekordbox is a software program allowing users who have purchased a Pioneer DJ player supporting rekordbox to manage music files to be used for DJ performances.

- rekordbox may be used for classifying and searching for music files stored on your computer as well as creating playlists, all of which can help improve your DJ performance.
- rekordbox allows the detecting, measuring, and editing of beats, tempos (BPM), and other elements of your music files prior to a performance.
- Hot cue point information can be set and saved ahead of time.

Not only can various types of point information and playlists prepared with rekordbox be used for playback on Pioneer DJ players, the playback history and point information can also be fed back to rekordbox after performances.

❖ Driver software

This driver software is an exclusive ASIO driver for outputting audio signals from the computer. To use this unit connected to a computer on which Windows is installed, install the driver software on the computer beforehand.

There is no need to install the driver software when using Mac OS X. For details, see *Installing the driver software* on page 26.

Software end user license agreement

This Software End User License Agreement ("Agreement") is between you (both the individual installing the Program and any single legal entity for which the individual is acting) ("You" or "Your") and PIONEER CORPORATION ("Pioneer").

TAKING ANY STEP TO SET UP OR INSTALL THE PROGRAM MEANS THAT YOU ACCEPT ALL OF THE TERMS OF THIS LICENSE AGREEMENT. PERMISSION TO DOWNLOAD AND/OR USE THE PROGRAM IS EXPRESSLY CONDITIONED ON YOUR FOLLOWING THESE TERMS. WRITTEN OR ELECTRONIC APPROVAL IS NOT REQUIRED TO MAKE THIS AGREEMENT VALID AND ENFORCEABLE. IF YOU DO NOT AGREE TO ALL OF THE TERMS OF THIS AGREEMENT, YOU ARE NOT AUTHORIZED TO USE THE PROGRAM AND MUST STOP INSTALLING IT OR UNINSTALL IT, AS APPLICABLE.

1 DEFINITIONS

- 1 "Documentation" means written documentation, specifications and help content made generally available by Pioneer to aid in installing and using the Program.
- 2 "Program" means all or any part of Pioneer's software licensed to You by Pioneer under this Agreement.

2 PROGRAM LICENSE

- 1 Limited License. Subject to this Agreement's restrictions, Pioneer grants to You a limited, non-exclusive, non-transferable, license (without the right to sublicense):
 - a To install a single copy of the Program in Your computer or mobile device, to use the Program only for Your personal purpose complying with this Agreement and the Documentation ("Authorized Use");
 - b To use the Documentation in support of Your Authorized Use; and
 - c To make one copy of the Program solely for backup purposes, provided that all titles and trademark, copyright and restricted rights notices are reproduced on the copy.

- 2 Restrictions. You will not copy or use the Program or Documentation except as expressly permitted by this Agreement. You will not transfer, sublicense, rent, lease or lend the Program, or use it for third-party training, commercial time-sharing or service bureau use. You will not Yourself or through any third party modify, reverse engineer, disassemble or decompile the Program, except to the extent expressly permitted by applicable law, and then only after You have notified Pioneer in writing of Your intended activities.
- 3 Ownership. Pioneer or its licensor retains all right, title and interest in and to all patent, copyright, trademark, trade secret and other intellectual property rights in the Program and Documentation, and any derivative works thereof. You do not acquire any other rights, express or implied, beyond the limited license set forth in this Agreement.
- 4 No Support. Pioneer has no obligation to provide support, maintenance, upgrades, modifications or new releases for the Program or Documentation under this Agreement.

3 WARRANTY DISCLAIMER

THE PROGRAM AND DOCUMENTATION ARE PROVIDED "AS IS" WITHOUT ANY REPRESENTATIONS OR WARRANTIES, AND YOU AGREE TO USE THEM AT YOUR SOLE RISK. TO THE FULLEST EXTENT PERMISSIBLE BY LAW, PIONEER EXPRESSLY DISCLAIMS ALL WARRANTIES OF ANY KIND WITH RESPECT TO THE PROGRAM AND DOCUMENTATION, WHETHER EXPRESS, IMPLIED, STATUTORY, OR ARISING OUT OF COURSE OF PERFORMANCE, COURSE OF DEALING OR USAGE OF TRADE, INCLUDING ANY WARRANTIES OF MERCHANTABILITY, FITNESS FOR A PARTICULAR PURPOSE, SATISFACTORY QUALITY, ACCURACY, TITLE OR NON-INFRINGEMENT.

4 DAMAGES AND REMEDIES FOR BREACH

You agree that any breach of this Agreement's restrictions would cause Pioneer irreparable harm for which money damages alone would be inadequate. In addition to damages and any other remedies to which Pioneer may be entitled, You agree that Pioneer may seek injunctive relief to prevent the actual, threatened or continued breach of this Agreement.

5 TERMINATION

Pioneer may terminate this Agreement at any time upon Your breach of any provision. If this Agreement is terminated, You will stop using the Program, permanently delete it from your computer or mobile device where it resides, and destroy all copies of the Program and Documentation in Your possession, confirming to Pioneer in writing that You have done so. Sections 2.2, 2.3, 2.4, 3, 4, 5 and 6 will continue in effect after this Agreement's termination.

6 GENERAL TERMS

- 1 Limitation of Liability. In no event will Pioneer or its subsidiaries be liable in connection with this Agreement or its subject matter, under any theory of liability, for any indirect, incidental, special, consequential or punitive damages, or damages for lost profits, revenue, business, savings, data, use, or cost of substitute procurement, even if advised of the possibility of such damages or if such damages are foreseeable. In no event will Pioneer's liability for all damages exceed the amounts actually paid by You to Pioneer or its subsidiaries for the Program. The parties acknowledge that the liability limits and risk allocation in this Agreement are reflected in the Program price and are essential elements of the bargain between the parties, without which Pioneer would not have provided the Program or entered into this Agreement.
- 2 The limitations or exclusions of warranties and liability contained in this Agreement do not affect or prejudice Your statutory rights as consumer and shall apply to You only to the extent such limitations or exclusions are permitted under the laws of the jurisdiction where You are located.
- 3 Severability and Waiver. If any provision of this Agreement is held to be illegal, invalid or otherwise unenforceable, that provision will be enforced to the extent possible or, if incapable of enforcement, deemed to be severed and deleted from this Agreement, and the remainder will continue in full force and effect. The waiver by either party of any default or breach of this Agreement will not waive any other or subsequent default or breach.
- 4 No Assignment. You may not assign, sell, transfer, delegate or otherwise dispose of this Agreement or any rights or obligations

under it, whether voluntarily or involuntarily, by operation of law or otherwise, without Pioneer's prior written consent. Any purported assignment, transfer or delegation by You will be null and void. Subject to the foregoing, this Agreement will be binding upon and will inure to the benefit of the parties and their respective successors and assigns.

5 Entire Agreement. This Agreement constitutes the entire agreement between the parties and supersedes all prior or contemporaneous agreements or representations, whether written or oral, concerning its subject matter. This Agreement may not be modified or amended without Pioneer's prior and express written consent, and no other act, document, usage or custom will be deemed to amend or modify this Agreement.

6 You agree that this Agreement shall be governed and construed by and under the laws of Japan.

Cautions on copyrights

rekordbox restricts playback and duplication of copyright-protected music contents.

- When coded data, etc., for protecting the copyright is embedded in the music contents, it may not be possible to operate the program normally.
- When rekordbox detects that coded data, etc., for protecting the copyright is embedded in the music contents, processing (playback, reading, etc.) may stop.

Recordings you have made are for your personal enjoyment and according to copyright laws may not be used without the consent of the copyright holder.

- Music recorded from CDs, etc., is protected by the copyright laws of individual countries and by international treaties. It is the full responsibility of the person who has recorded the music to ensure that it is used legally.
- When handling music downloaded from the Internet, etc., it is the full responsibility of the person who has downloaded the music to ensure that it is used in accordance with the contract concluded with the download site.

Cautions on installing rekordbox

Read *Software end user license agreement* carefully before installing rekordbox.

- The included CD-ROM contains installation programs and operating instructions in the following 12 languages: English, French, German, Italian, Dutch, Spanish, Portuguese, Russian, Chinese (simplified characters), Chinese (traditional characters), Korean, Japanese.
- When using an operating system in any language besides the ones listed above, select **[English]** during the installation procedure.

Supported operating systems

Mac OS X (10.5.8, 10.6, 10.7 or 10.8)		✓
Windows® 8/Windows® 8 Pro	32-bit version	✓
	64-bit version	✓
Windows® 7 Home Premium/Professional/Ultimate	32-bit version	✓
	64-bit version	✓
Windows Vista® Home Basic/Home Premium/Business/Ultimate (SP2 or later)	32-bit version	✓
	64-bit version	✓
Windows® XP Home Edition/Professional (SP3 or later)	32-bit version	✓

The latest information on rekordbox (supported operating systems, required operating environment, etc.) is provided on the rekordbox online support site. (Page 8)

❖ Minimum operating environment for rekordbox

Check that the computer provides the operating environment described below before starting installation.

CPU	For Mac OS X	Macintosh computer equipped with a Dual-Core 1.6 GHz or greater Intel® processor
	For Windows® 8, Windows® 7, Windows Vista® and Windows® XP	PC/AT compatible computer equipped with a Dual-Core 2.0 GHz or greater Intel® processor
Required memory	1 GB or more of RAM	
Hard disk	250 MB or more of free space (not including space for storing music files, etc.)	
Optical drive	Optical disc drive on which the CD-ROM can be read	
Sound	Audio output to speakers, headphones, etc. (internal or external audio device)	
Internet connection	For user registration and inquiries, use a web browser supporting 128-bit SSL (Safari 2.0 or greater, Internet Explorer® 6.0 or greater, etc.).	
USB port	A USB port for connection of a USB device (flash memory, hard disc, etc.) is required to transfer music files to the USB device.	

- Full functionality is not guaranteed on all computers, even those meeting the operating environment requirements described above.
- Even with the required memory capacity indicated for the operating environment above, in the cases described below the software may not provide full functionality and performance due to lack of memory. In this case, take the necessary measures to ensure sufficient free memory. We recommend adding extra memory in order to achieve stable performance.
 - When there are many tracks being managed in the rekordbox library
 - When resident programs and services are running
- Depending on the computer's power settings and other factors, the CPU and hard disk processing capacity may be insufficient. When using laptop computers in particular, always keep the AC power connected and adjust the computer's settings to maximize performance when using rekordbox.
- Note that problems may arise with the functionality of rekordbox depending on other software running on your computer.

Installing rekordbox

Read *Cautions on installing rekordbox* carefully before installing rekordbox.

❖ Installation procedure (Macintosh)

- Authorization of the computer's administrator is required to install and uninstall rekordbox. Log on as the user which was set as the computer's administrator before installing.

1 When the included CD-ROM is inserted into the computer's CD drive, the CD drive opens on the screen. Double-click the [CD_menu.app] icon.

- If the CD drive does not open on the screen when the CD-ROM is inserted, use Finder to open the CD drive, then double-click the [CD_menu.app] icon.

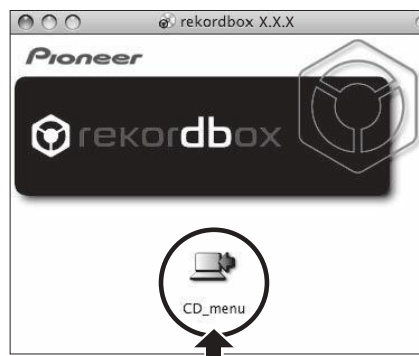

2 When the CD-ROM's menu is displayed, select [rekordbox: Install Music Management Software], then click [Start].

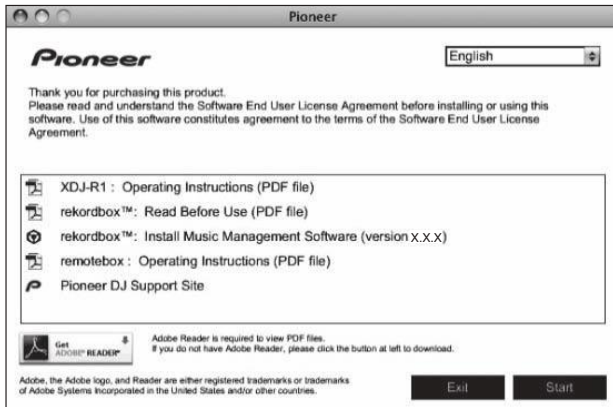

- To close the CD-ROM menu, click [Exit].

3 When the license agreement screen appears, select [English], read the *Software end user license agreement* carefully, then click [Continue].

- You can select the one you desire from multiple languages as long as the language is supported by the system environment of your computer.

4 If you agree to the *Software end user license agreement*, click [Agree].

- If you do not consent to the provisions of the *Software end user license agreement*, click [Disagree] and stop installation.

5 Install rekordbox by following the instructions on the screen.

❖ Installation procedure (Windows)

- Authorization of the computer's administrator is required to install and uninstall rekordbox.
Log on as the user registered as the computer's administrator before installing rekordbox.

1 Insert the included CD-ROM into the computer's CD drive.

The CD-ROM menu is displayed.

- If the CD-ROM menu does not appear when the CD-ROM is inserted, open the CD drive from [Computer (or My Computer)] in the [Start] menu, then double-click the [CD_menu.exe] icon.

2 When the CD-ROM's menu is displayed, select [rekordbox: Install Music Management Software], then click [Start].

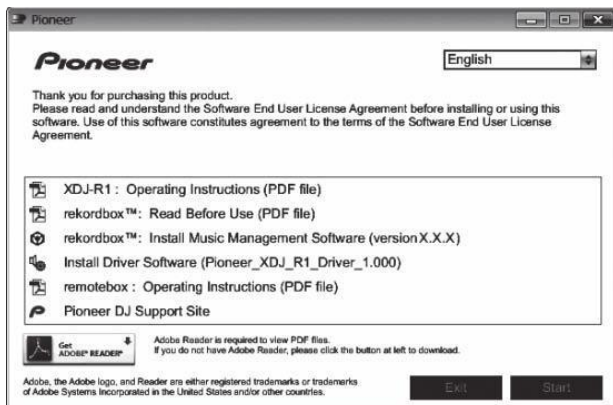

- To close the CD-ROM menu, click [Exit].

3 When the language selection screen appears, select [English] and click [OK].

- You can select the one you desire from multiple languages as long as the language is supported by the system environment of your computer.

4 When the license agreement screen appears, read the *Software end user license agreement* carefully. If you agree to the *Software end user license agreement*, click [Agree].

- If you do not consent to the provisions of the *Software end user license agreement*, click [Cancel] and stop installation.

5 Install rekordbox by following the instructions on the screen.

- Click [Cancel] to cancel installation after it has started.

Launching rekordbox/Viewing the Operating Instructions

Log on as the user which was set as the computer's administrator before using rekordbox.

- When rekordbox is started up for the first time, the license key must be entered. The license key is affixed to the CD-ROM package.

When rekordbox is started up, the operating instructions can be viewed from the rekordbox [Help] menu.

- The Online manual and online support site can be accessed if the computer is connected to the Internet.

❖ For Mac OS X

Open the [Application] folder with Finder, then double-click [rekordbox 2.x.x.app].

- The 2.x.x indicates the rekordbox version.

❖ For Windows® 8, Windows® 7, Windows Vista® and Windows® XP

Double-click the [rekordbox 2.x.x] icon (shortcut) on the desktop.

- The 2.x.x indicates the rekordbox version.

Using the online support site

Before making inquiries on rekordbox operating procedures or technical issues, read the rekordbox operating instructions and online manual and check the FAQ provided on the rekordbox online support site.

<rekordbox online support site>

<http://rekordbox.com/>

- User registration on the rekordbox online support site is required prior to making inquiries concerning rekordbox.
- You will need to enter your license key during user registration, so please have it handy. Also, be sure not to forget the login name (your e-mail address) and the password specified for your user registration, as well as the license key.
- PIONEER CORPORATION collects your personal information for the following purposes:
 - 1 To provide customer support for your purchased product
 - 2 To inform you of product or event information by e-mail
 - 3 To obtain feedback collected by survey for product planning purposes
 - Your personal information is kept confidential corresponding to the privacy policy set forth by our company.
 - Pioneer's privacy policy can be viewed on the rekordbox online support site.
- When making inquiries regarding rekordbox, please be sure to furnish your computer type and specifications (CPU, installed memory, other connected peripherals, etc.), the operating system and version used, as well as concrete information regarding the issue at hand.

- To inquire about configuring your computer with non-Pioneer peripheral devices and to obtain the corresponding technical support, contact the specific manufacturer or retailer.
- Further version updates are anticipated for improved functionality and performance of rekordbox. Update programs will be available for download on the rekordbox online support site. We strongly recommend you perform these updates and always use the latest version of rekordbox.

Installing remotebox

Install remotebox on the mobile device (smartphone, tablet device, etc.). For the installation procedure and supported operating system versions, see the remotebox operating instructions or the Pioneer website (<http://pioneerdj.com/support/>).

Connections

- Connect the power cord after all the connections between devices have been completed.
Be sure to turn off the power and unplug the power cord from the power outlet whenever making or changing connections.
Refer to the operating instructions for the component to be connected.
- Be sure to use the included power cord.

Connecting the input/output terminals

Rear panel, front panel

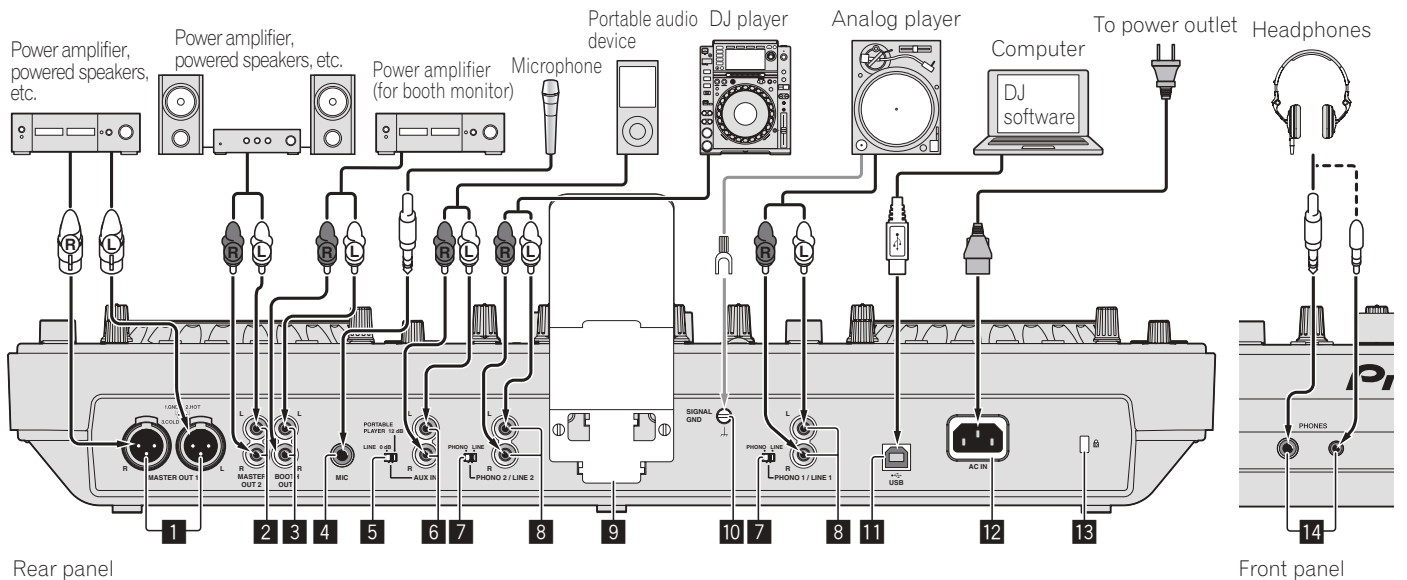

Rear panel

Front panel

1 MASTER OUT 1 terminals

Connect a power amplifier, powered speakers, etc., here.
Be sure to use these as balanced outputs. **Be careful not to accidentally insert the power cord of another unit.**

2 MASTER OUT 2 terminals

Connect a power amplifier, powered speakers, etc., here.

3 BOOTH output terminal

This is an output terminal for a booth monitor.

4 MIC jack

Connects a microphone here.

5 LINE, PORTABLE PLAYER selector switch

Switch this according to the audio level input to the [AUX] terminals.

6 AUX IN terminals

Connect a line level output device (such as a DJ player) or a device with a low gain (such as a portable audio player) here. Switch the terminals' input gain according to the connected device using the [LINE, PORTABLE PLAYER] selector switch on this unit's rear panel.

7 LINE, PHONO selector switch

Switches the function of the [PHONO/LINE] terminals.

8 PHONO1/LINE1 and PHONO2/LINE2 terminals

Connect a phono level output device (analog player (for MM cartridges), etc.) or a line level output device (DJ player, etc.) here. Switch the terminals' function according to the connected device using the [LINE, PHONO] selector switch on this unit's rear panel.

9 Smartphone stand

A mobile device can be set here.
For instructions on mounting the smartphone stand, see *Mounting the smartphone stand* on page 4.

10 SIGNAL GND terminal

Connects an analog player's ground wire here. This helps reduce noise when the analog player is connected.

11 USB terminal

Connect to a computer.

- A USB hub cannot be used.
- To maintain performance, use with this unit and the computer connected directly using the included USB cable.

12 AC IN

Connect this to a power outlet.

Connect the power cord after all the connections between devices have been completed.

Be sure to use the included power cord.

13 Kensington security slot

14 PHONES jacks

Connect headphones here.

Both stereo phone plugs (Ø 6.3 mm) and stereo mini phone plugs (Ø 3.5 mm) can be used.

- There are two output terminals (one for a stereo phone jack and one for a mini-phone jack), but do not use both terminals simultaneously. If one is connected or disconnected while the other one is being used, the volume of the other one in use may increase or drop suddenly.

Connecting by wireless LAN

With this unit, a mobile device supporting wireless LAN connections can be connected directly without using router, etc., to hold DJ performances using the mobile device application (remotebox). This unit does not support wireless LAN connection via a router.

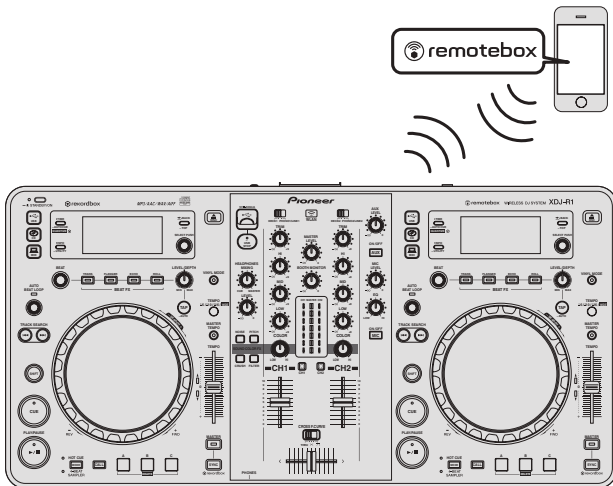

Setting the wireless LAN function's operation mode

Set the wireless LAN function's operation mode before connecting this unit by wireless LAN. The buttons and controls below are used for making the wireless LAN function's operation mode settings and wireless LAN connection settings.

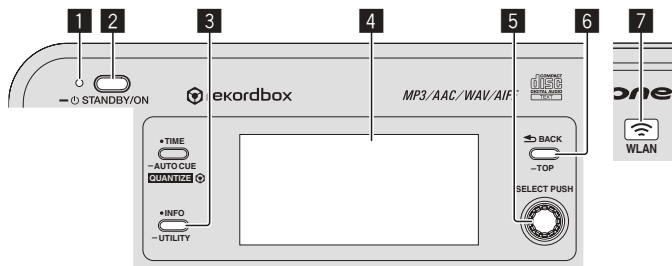

- 1 STANDBY/ON indicator
- 2 STANDBY/ON button
- 3 INFO(UTILITY) button
- 4 Main unit display
- 5 Rotary selector (SELECT PUSH)
- 6 BACK(TOP) button
- 7 WLAN indicator

1 Press the [STANDBY/ON] button.

Turn on the power of this unit.
The [STANDBY/ON] indicator lights green.

2 Press the [INFO(UTILITY)] button for over 1 second.

The [UTILITY] screen is displayed.

3 Turn the rotary selector, select [WLAN SETTING], then press the rotary selector.

See page 25 for the list of [WLAN SETTING] items.

4 Turn the rotary selector, select [MODE], then press the rotary selector.

5 Turn the rotary selector, select the mode you want to set, then press the rotary selector.

- [ENABLE]: Activates the wireless LAN function.
- [DISABLE]: Turns the wireless LAN function off.

6 When [APPLY CHANGES?] appears on the main unit display, turn the rotary selector to select [YES], then press the rotary selector.

After this, make the settings for connection in the ENABLE mode.

Making the wireless LAN connection settings in the ENABLE mode

1 Press the [INFO(UTILITY)] button for over 1 second.

2 Turn the rotary selector, select [WLAN INFO], then press the rotary selector.

3 Turn the rotary selector, select [SSID], then press the rotary selector.

Make a note of the [SSID] for future reference.

- The first 9 characters of the [SSID] are displayed. Turn the rotary selector to display the portion that is not initially displayed.

4 Press the [BACK(TOP)] button.

Press to return to the previous screen.

5 Turn the rotary selector, select [PASSWORD], then press the rotary selector.

Make a note of the [PASSWORD] for future reference.

6 From the wireless LAN connection settings on the mobile device or computer, display the connectable [SSID]s.

- See your device's operating instructions for instructions on searching for or displaying connectable [SSID]s.

7 On the mobile device or computer, select the [SSID] checked in step 3.

8 Input the password you made a note of in step 5.

- For safety, be sure to change the default password. We recommend changing the password periodically.

Checking the current wireless LAN settings

1 Press the [INFO(UTILITY)] button for over 1 second.

The [UTILITY] screen is displayed.

2 Turn the rotary selector, select [WLAN INFO], then press the rotary selector.

See page 24 for the list of [WLAN INFO] items.

3 Select the item you want to check, then press the rotary selector.

The settings are displayed.

- When the [BACK(TOP)] button is pressed, the screen returns to the [WLAN INFO] screen.

4 Press the [INFO(UTILITY)] button.

The [UTILITY] screen closes.

Changing the SSID and password

1 Press the [INFO(UTILITY)] button for over 1 second.

The [UTILITY] screen is displayed.

2 Turn the rotary selector, select [WLAN SETTING], then press the rotary selector.

3 Turn the rotary selector, select [NETWORK SETTING], then press the rotary selector.

4 Turn the rotary selector, input the [SSID], then press the rotary selector.

5 Turn the rotary selector and set the security type at [SECURITY].

[WEP64]: A 5-character password can be set.

[WEP128]: A 13-character password can be set.

[OPEN]: No password is set. Access is open to everyone.

- For a stronger security level, we recommend setting [WEP128] and changing the password periodically.

6 Turn the rotary selector and set the password.

7 When [APPLY CHANGES?] appears on the main unit display, turn the rotary selector to select [YES], then press the rotary selector.

8 Press the [INFO(UTILITY)] button.

The [UTILITY] screen closes.

Cautions concerning security when using wireless LAN products

Wireless LAN connections offer the advantage that because the information is exchanged between the computer, etc., and the wireless LAN access point using radio waves rather than a LAN cable, LAN connections are possible as long as the devices are within the range of the radio waves.

On the other hand, because the radio waves reach all places within their range, even through such obstacles as walls, the problems below may occur if the security settings have not been made.

- Exchanged information may be viewed surreptitiously
Third parties with malicious intents may deliberately intercept the radio waves and surreptitiously view the exchanged information, including ID numbers, passwords, credit card numbers and other personal information or e-mail messages.
- Your network may be infiltrated without authorization
Third parties with malicious intents may access your personal or company network without authorization and obtain personal or confidential information (leakage of information), impersonate specific persons and release false information (impersonation), rewrite intercepted information and issue the rewritten information (falsification) or plant computer viruses, etc., that damage your data or system (vandalism).

Wireless LAN products normally have a security system. Using the product with the security settings activated decreases the above risks.

It is your responsibility to thoroughly understand the risks of using wireless LAN products without security settings and to make the security settings according to your personal judgment.

Part names and functions

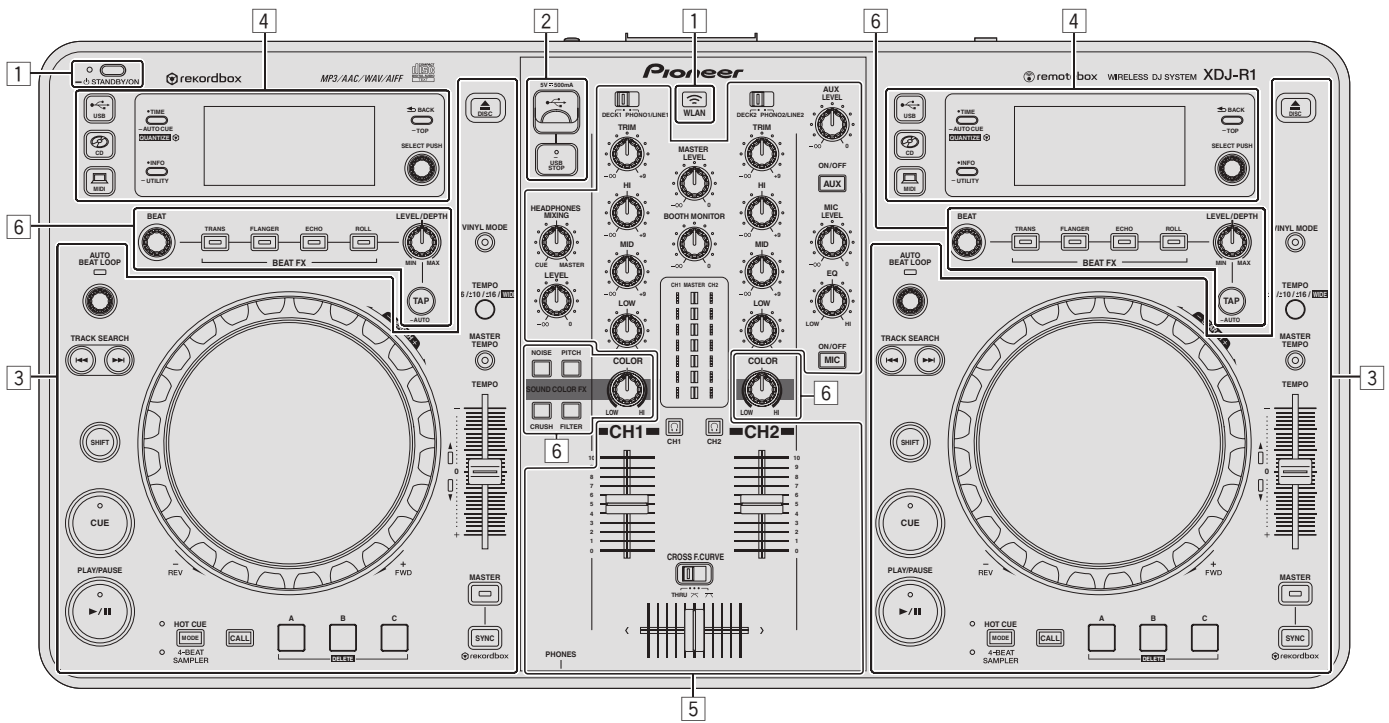

- 1 Power & wireless section (page 14)
- 2 USB device section (page 14)
- 3 Player section (page 14)
- 4 Browse section (page 17)
- 5 Mixer section (page 18)
- 6 Effect section (page 19)

Power & wireless section

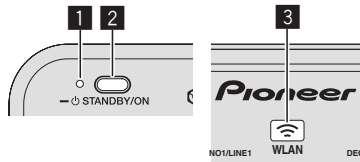

1 STANDBY/ON indicator

This lights when this unit's power is on or in standby.

2 STANDBY/ON button

This switches this unit's power between on and standby.

➔ *Turning the power on* (p.21)

➔ *To set to the standby mode* (p.21)

3 WLAN indicator

This lights when a link is established with the mobile device.

USB device section

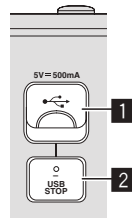

1 USB device insertion slot

Insert USB devices here.

➔ *Connecting and disconnecting USB devices* (p.22)

2 USB STOP button

Press this for over 2 seconds before disconnecting USB devices from this unit.

Player section

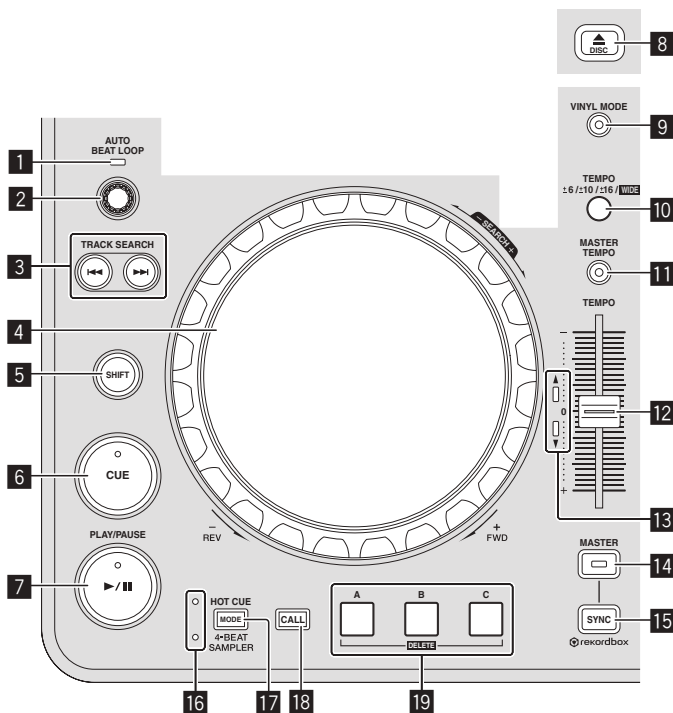

1 AUTO BEAT LOOP indicator

This lights during loop playback.

2 AUTO BEAT LOOP control

- Turn:
Set the length of the auto beat loop's loop in units of beats.
- Press:
Turns loop playback on and off.

3 TRACK SEARCH ◀◀, ▶▶ buttons

Use these to search for the beginnings of tracks.

4 Jog dial

- Scratch
When the [VINYL] mode is set and the jog dial is turned while touching a metal part on its top, the sound is played according to the direction and speed at which the jog dial is turned.
- Pitch bend
The playing speed can be adjusted by turning the outer part of the jog dial during playback.

5 SHIFT button

When another button is pressed while pressing the [SHIFT] button, a different function is called out.

6 CUE button

Sets a cue point or moves the cue point.

➔ *Setting Cue* (p.15)

7 ▶/II (PLAY/PAUSE) button

Use this to play/pause tracks.

8 DISC button

Use this to eject discs.

➔ *Ejecting discs* (p.21)

9 VINYL MODE button

Use this to switch between the [VINYL] mode and normal mode.

10 TEMPO RANGE button

The [TEMPO] slider's range of variation switches each time this is pressed.

11 MASTER TEMPO button

Use this to turn the master tempo function on and off.

12 TEMPO slider

Use this to adjust the track playing speed.

13 TEMPO indicator

When the upper or lower indicator is flashing, if the [TEMPO] slider is moved in the direction of the lit indicator until the indicator turns off, operations with the [TEMPO] slider are enabled. When one of the indicators is lit, operations with the [TEMPO] slider are disabled.

14 MASTER button

Use this to set the track loaded in this unit as the master for the beat sync function.

➔ *Using the SYNC function* (p.23)

15 SYNC button

Synchronizes to the master deck's tempo.

➔ *Using the SYNC function* (p.23)

16 HOT CUE/4-BEAT SAMPLER indicator

These light to indicate whether the hot cue/sampler section is set to the hot cue or sampler function.

17 MODE (HOT CUE/4-BEAT SAMPLER) button

Switches the function of the hot cue/sampler section with each press.

18 CALL button

Calls out the hot cue.

19 HOT CUE/4-BEAT SAMPLER (A, B, C) button

When using with the hot cue function

- Press:
— When no hot cue is set during playback or while pausing:
A hot cue is set at the position at which the button is pressed.

- When a hot cue is set during playback or while pausing:
The hot cue is played.

- **[SHIFT] + press:**
Deletes the hot cue.

When using with the sampler function

For details, see *Using the sampler function* on page 17.

Playback

Press the **[▶/II (PLAY/PAUSE)]** button.

❖ Pausing

During playback, press the **[▶/II (PLAY/PAUSE)]** button.

- Playback resumes when **[▶/II (PLAY/PAUSE)]** button is pressed again.
- When tracks have been loaded from a disc, the disc automatically stops spinning if no operation is performed for 100 minutes while in the pause mode.

Forward and reverse scanning

Turn the jog dial while pressing the **[SHIFT]** button.

The track is fast-forwarded/fast-reversed in the direction in which the jog dial is spun.

- When the **[SHIFT]** button is released, this function is canceled.
- When you stop the jog dial from spinning, normal playback resumes.
- The fast-forward/fast-reverse speed can be adjusted according to the speed at which the jog dial is spun.

Finding the beginnings of tracks (Track Search)

Press one of the **[TRACK SEARCH ◀◀, ▶▶]** buttons.

Press the **[▶▶]** to move to the beginning of the next track.

When **[◀◀]** is pressed, playback returns to the beginning of the currently playing track. When pressed twice in a row, playback returns to the beginning of the previous track.

- It is not possible to move to a different category or folder with the track search function.

Frame search

In the pause mode, spin the jog dial.

The pause position can be moved in units of single frames.

- The position is moved in the direction of playback when the jog dial is spun clockwise, in the reverse direction when it is spun counter-clockwise. The position moves 135 for one revolution of the jog dial.

Super fast track search

Turn the jog dial while pressing one of the **[TRACK SEARCH ◀◀, ▶▶]** buttons.

The track is advanced at high speed in the direction in which the jog dial was turned.

Adjusting the playing speed (Tempo control)

Move the **[TEMPO]** slider forward or backward.

The playing speed increases when the slider is moved to the **[+]** side (towards you), decreases when the slider is moved to the **[-]** side (away from you).

The rate at which the playing speed is changed is indicated on the main unit display.

❖ Selecting the playing speed adjustment range

Press the **[TEMPO RANGE]** button.

The playing speed adjustment range switches each time the button is pressed.

[WIDE, ±16, ±10, ±6] is displayed on the main unit display.

- Adjustment is possible in units of 0.02 % when **[±6]** % is selected, 0.04 % when **[±10]** % or **[±16]** % is selected, and 0.5 % when **[WIDE]** is selected.
- The **[WIDE]** adjustment range is ±100 %. When set to -100 %, playback stops.
- **[WIDE]** can only be selected when playing music CDs (CD-DA).

❖ Adjusting the playing speed without changing the pitch (Master Tempo)

Press the **[MASTER TEMPO]** button.

The **[MASTER TEMPO]** indicator lights. The pitch does not change even when the playing speed is changed with the **[TEMPO]** slider.

- The sound is digitally processed, so the sound quality changes.

Setting Cue

1 During playback, press the **[▶/II (PLAY/PAUSE)]** button.

Playback is paused.

2 Press the **[CUE]** button.

The point at which the track is paused is set as the cue point.

The **[▶/II (PLAY/PAUSE)]** indicator flashes and the **[CUE]** indicator lights. No sound is output at this time.

- When a new cue point is set, the previously set cue point is canceled.

❖ Adjusting the cue point position

1 When paused at the cue point, touch the top of the jog dial while pressing the **[SHIFT]** button.

The **[▶/II (PLAY/PAUSE)]** and **[CUE]** indicators flash.

The cue point can be fine-adjusted in units of single frames.

2 Press the **[CUE]** button.

The position at which the button was pressed is set as the new cue point.

- When a new cue point is set, the previously set cue point is canceled.

❖ Returning to Cue Point (Back Cue)

During playback, press the **[CUE]** button.

The set immediately returns to the currently set cue point and pauses.

- When the **[▶/II (PLAY/PAUSE)]** button is pressed, playback starts from the cue point.

❖ Checking Cue Point (Cue Point Sampler)

Keep pressing the **[CUE]** button after returning to the cue point.

Playback starts from the set cue point. Playback continues while the button is held in.

Setting the loop automatically based on the track's tempo (Auto Beat Loop)

1 During playback, turn the [AUTO BEAT LOOP] control to set the length for loop playback in number of beats.

The contents displayed on the main unit display switch to the auto beat loop/effect display.

2 Press the [AUTO BEAT LOOP] control to start loop playback.

The loop out point is set automatically according to the track's tempo (BPM) and loop playback starts.

- Loop playback cannot be performed properly if the BPM value is not displayed.
- When auto beat loop is set, the cue point moves to the loop in point.
- When the [AUTO BEAT LOOP] control is pressed during loop playback, loop playback is canceled.

Operating the jog dial

- The top of the jog dial has an embedded switch. Do not place objects on the jog dial or subject it to strong forces.
- Water or other liquids getting into the set will lead to malfunction.

❖ Switching the jog dial mode

The jog dial has two modes.

- [VINYL] mode: When a metal part of the top of jog dial is touched during playback, playback stops, and when the jog dial is turned at this point the sound is output according to the rotation of the jog dial.
- Normal mode: Playback does not stop even when a metal part of the top of jog dial is touched. Also, such operations as scratching cannot be performed.

Press the [VINYL MODE] button.

The jog mode switches to the [VINYL] mode and the [VINYL MODE] button lights.

❖ Scratch

When the jog dial is set to the [VINYL] mode, the sound can be played according to the direction and speed at which the jog dial is turned by turning the jog dial while touching a metal part on its top.

1 Press the [VINYL MODE] button.

Set the jog mode to the [VINYL] mode.

2 During playback, touch a metal part of the top of the jog dial.

Playback stops.

3 While still touching a metal part of the top of the jog dial, turn the jog dial in the direction and at the speed at which you want to play the sound.

The sound is played according to the spinning direction and speed of the jog dial.

4 Take your finger off the metal part of the top of the jog dial.

Normal playback resumes.

❖ Pitch bend

During playback, spin the outer section of the jog dial.

The playing speed increases when spun clockwise, decreases when spun counterclockwise. When spinning is stopped, playback returns to the normal speed.

- When the jog mode is set to the normal mode, the same operation is possible by spinning the top of the jog dial.

Using hot cues

When a hot cue is set, the point can be called out instantaneously and playback can be started from that point. A maximum of 3 hot cues can be set per disc. For music files on USB devices, up to 3 hot cues can be set per track.

❖ Setting Hot Cue

1 Press the [MODE (HOT CUE/4-BEAT SAMPLER)] button to switch to the hot cue mode.

The [HOT CUE] indicator lights.

2 During playback or while pausing, press one of the [HOT CUE/4-BEAT SAMPLER (A, B, C)] buttons at the point at which you want to set the hot cue.

The point at which the button was pressed is set as the hot cue, and the corresponding [HOT CUE/4-BEAT SAMPLER (A, B, C)] button lights blue.

- During loop playback, the loop is registered as a hot cue.
- The direction of playback is not recorded for hot cues.
- When a hot cue is set during scratch play, playback may stop temporarily.
- When the quantize function is on, there may be a slight delay in operation of this function in order to synchronize the beat.
- It is not possible to store a hot cue at a [HOT CUE/4-BEAT SAMPLER (A, B, C)] button at which a hot cue is already stored. To do so, first delete the hot cue stored at that button.

❖ Playing hot cues

During playback or while pausing, press one of the [HOT CUE/4-BEAT SAMPLER (A, B, C)] buttons.

The hot cue recorded at that button is called out and playback begins.

❖ Calling out hot cues (on discs)

1 Load a disc in this unit.

2 Press the [CALL] button.

The unit switches to the hot cue callout mode and the [HOT CUE/4-BEAT SAMPLER (A, B, C)] buttons at which hot cues are stored flash.

3 Press the [HOT CUE/4-BEAT SAMPLER (A, B, C)] button whose hot cue you want to call out.

The hot cue is called out and the [HOT CUE/4-BEAT SAMPLER (A, B, C)] button lights blue.

- If you do not want to call out a hot cue, press the [CALL] button without pressing a [HOT CUE/4-BEAT SAMPLER (A, B, C)] button. The buttons whose hot cues were not called out turn off.

❖ Calling out hot cues (on a storage (USB) device)

1 Connect a storage device (USB) to this unit.

2 Load the track whose hot cue you want to call out.

3 Press the [CALL] button.

The unit switches to the hot cue callout mode and the [HOT CUE/4-BEAT SAMPLER (A, B, C)] buttons at which hot cues are stored flash.

4 Press the [HOT CUE/4-BEAT SAMPLER (A, B, C)] button whose hot cue you want to call out.

The hot cue is called out and the [HOT CUE/4-BEAT SAMPLER (A, B, C)] button lights blue.

- If you do not want to call out a hot cue, press the [CALL] button without pressing a [HOT CUE/4-BEAT SAMPLER (A, B, C)] button. The buttons whose hot cues were not called out turn off.

- If you accidentally cancel the hot cue callout mode, once again press the **[CALL]** button.
- rekordbox can be preset so that hot cues are called out automatically when tracks are loaded.



"**H**" is displayed on the track list for tracks for which auto hot cue loading is set.

❖ Deleting hot cues

Press one of the **[HOT CUE/4-BEAT SAMPLER (A, B, C)]** buttons while pressing the **[SHIFT]** button.

The hot cue stored at the corresponding button is deleted, the button turns off, and a new hot cue can now be stored at that button.

Using the sampler function

Four beats of sound can be sampled. Samples that have been stored can be called out and played later.

- Up to three samples can be stored per deck.
- After editing (recording or deleting) a sampled sound source, be sure to press the **[STANDBY/ON]** button to turn the power off. If the power is turned off without pressing the **[STANDBY/ON]** button, the edited results are not retained in the memory.

❖ Storing samples

1 Press the [MODE (HOT CUE/4-BEAT SAMPLER)] button to switch to the sampler mode.

The **[4-BEAT SAMPLER]** indicator lights.

2 Press one of the [HOT CUE/4-BEAT SAMPLER (A, B, C)] buttons.

The point at which the button is pressed is set as the recording start point, four beats worth of sound or the first 5 seconds of the sound is sampled, and the button lights blue.

- If a sample is already stored at a **[HOT CUE/4-BEAT SAMPLER (A, B, C)]** button, it is not possible to store a new sample there. To store a new sample, first delete the stored sample.

❖ Playing samples

Press and hold a **[HOT CUE/4-BEAT SAMPLER (A, B, C)]** button.

The sample is played while the button is pressed.

- The volume of the sample can be adjusted at **[SAMPLE LEVEL]** on the **[UTILITY]** menu.

❖ Deleting samples

Press one of the **[HOT CUE/4-BEAT SAMPLER (A, B, C)]** buttons while pressing the **[SHIFT]** button.

The sampled sound stored at the corresponding button is deleted, the button turns off, and a new sample can now be stored at that button.

Browse section

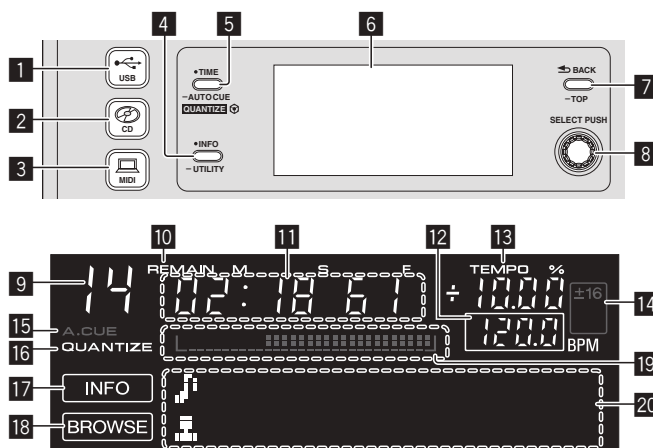

1 USB button

Press this to play the music files on a USB device.

➔ *Playing media connected to or inserted in this unit (p.22)*

2 CD button

Press this to play the music files on a CD or CD-ROM.

➔ *Playing media connected to or inserted in this unit (p.22)*

3 MIDI button

Press this to use DJ software.

➔ *Using the DJ software (p.27)*

4 INFO(UTILITY) button

- Press:
The main unit display switches to the information display mode. When in the information display mode, the information display section switches between the track name display, beat display or auto loop/effect display each time the button is pressed.
- Press for over 1 second:
The **[UTILITY]** screen is displayed.
➔ *Changing the settings (p.24)*

5 TIME (AUTO CUE,QUANTIZE) button

- Press:
The main unit display's time display mode switches to the elapsed time or remaining time display.
- Press for over 1 second:
When pressed for over 1 second, auto cue turns on and off.
- **[SHIFT]** + press:
This turns the **QUANTIZE** function on and off.
➔ *Using the QUANTIZE function (p.23)*

6 Main unit display

7 BACK(TOP) button

- Press:
The screen moves back to the layer above.
- Press for over 1 second:
Press for over 1 second to move to the top layer.

8 Rotary selector (SELECT PUSH)

9 This displays the track number.

10 REMAIN

This is displayed when the time display is set to the remaining time.

11 Time display (minutes, seconds and frames)

12 BPM

Displays BPM (Beats Per Minute) of the track currently being played. The value changes according to the position of the **[TEMPO]** slider.

13 TEMPO %

This indicates the percentage by which the playing speed is changed.

14 Playing speed adjustment range display

This indicates the range by which the playing speed can be adjusted.

15 A. CUE

This is displayed when the auto cue mode is set.

16 QUANTIZE

This is displayed when [QUANTIZE] is turned on.

17 INFO

This is displayed when the main unit display is set to the information display mode.

18 BROWSE

This is displayed when the main unit display is set to the browse display mode.

19 Playing address display

This displays a track as a bar graph. The graph lights up from the left edge when the elapsed time is displayed and turns off from the left edge when the remaining time is displayed. The entire graphs starts flashing slowly when only 30 seconds remain to the end of the track, then starts flashing quickly when only 15 seconds remain.

20 Information display section

Switching the browse display mode

There are two types of browse display modes: library browse and folder browse. The display mode differs according to whether or not rekordbox library information is stored on the USB device.

- When library information is stored on the USB device: The display is set to the library browse mode. The music files are displayed in five categories (artist, album, title, BPM and playlist).
- When no library information is stored on the USB device: The information is displayed in the folder browse mode. The folders and tracks on the medium are displayed in a tree structure.

Switching the information display mode

The information display section switches between the track name display, beat display or auto loop/effect display each time the [INFO(UTILITY)] button is pressed.

❖ Using the beat display function

This displays the beat and playback position of the currently playing track.

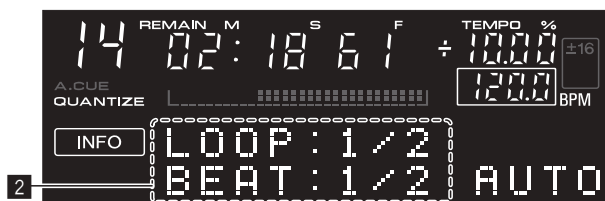
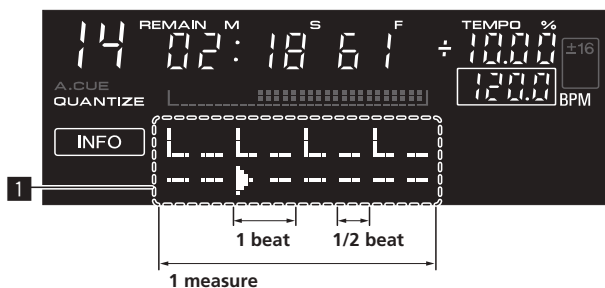

1 Beat display section

2 Auto loop/effect display section

- When the track name display is selected in the information display mode, it automatically switches to the auto loop/effect display when one of the following operations is performed:
 - Auto beat loop setting
 - Effect setting

Setting auto cue

When a track is loaded or the track search operation is performed, the silent section at the beginning of the track is skipped and the cue point is automatically set at the point immediately before the sound starts.

Press the [TIME (AUTO CUE, QUANTIZE)] button for over 1 second.

Auto cue is set to on.

[A. CUE] is displayed on the main unit display.

- When the [TIME (AUTO CUE, QUANTIZE)] button is pressed again for over 1 second, auto cue is set to off.
- The auto cue level setting remains in the memory, even when the power is turned off.

❖ Changing the auto cue level

The acoustic pressure level identified as a silent section with the auto cue function can be selected from eight levels.

- The auto cue level setting remains in the memory, even when the power is turned off.

1 Press the [INFO(UTILITY)] button for over 1 second.

The [UTILITY] screen is displayed.

2 Turn the rotary selector then press it.

Select [A. CUE LEVEL].

3 Turn the rotary selector then press it.

The auto cue level setting changes.

Mixer section

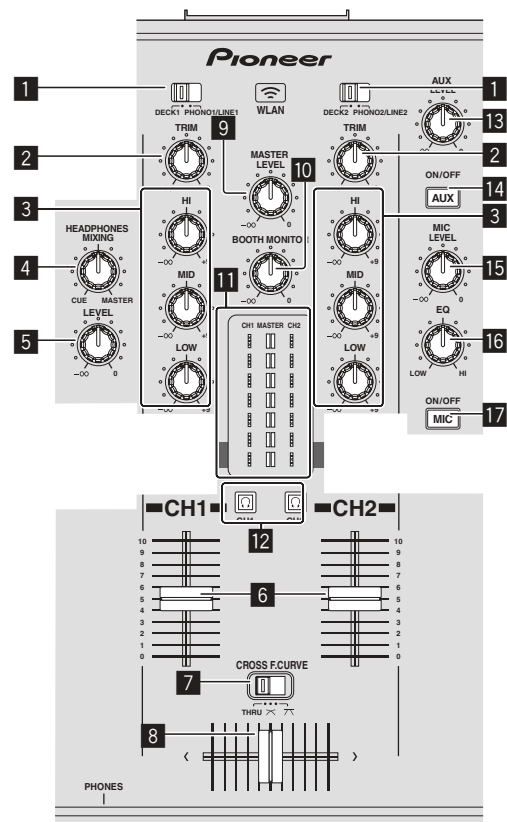

1 DECK, PHONO/LINE selector switch

Used to select the [CH 1] or [CH 2] input source from among the devices connected to this unit.

- When set to [PHONO/LINE], the mixer section can be used as a DJ mixer.

2 TRIM control

Adjusts the level of audio signals input in each channel.

3 EQ (HI, MID, LOW) controls

These adjust the sound quality of the respective channels.
These adjust the [HI] (high range), [MID] (middle range) and [LOW] (low range), respectively.

4 HEADPHONES MIXING control

Adjusts the balance of the monitor volume between the sound of the deck whose [🎧] button is pressed and the master sound.

5 HEADPHONES LEVEL control

Adjusts the audio level output from the [PHONES] terminal.

6 Channel fader

Adjusts the level of audio signals output in each channel.

7 CROSS F. CURVE (THRU, ㄨ, ㄨ) (crossfader curve selector switch)

This switches the crossfader curve characteristics.

8 Crossfader

The sound of the respective channels is output according to the curve characteristics selected with the [THRU, ㄨ, ㄨ] selector switch.

9 MASTER LEVEL control

Adjusts the audio level output from the [MASTER OUT 1] and [MASTER OUT 2] terminals.

10 BOOTH MONITOR control

Adjusts the level of audio signals output from the [BOOTH] terminal.

11 LEVEL indicator

This displays the audio levels of the respective channels.

12 🎧 (CH1, CH2) button

Used to monitor the [CH 1] or [CH 2] sound.

13 AUX LEVEL control

Adjusts the audio level input to the [AUX IN] terminals.

14 AUX (ON/OFF) button

These turn the AUX effects on/off.

15 MIC LEVEL control

Adjusts the audio level input to the [MIC] terminal.

16 MIC EQ control

This adjusts the microphone's sound quality.

17 MIC (ON/OFF) button

Turns the microphone on/off.

Adjusting the sound quality**Turn the [HI], [MID], [LOW] controls for the respective channels.**

- The sound for that range can be turned completely off by turning the control all the way counterclockwise (isolator function).

Monitoring sound with headphones**1 Connect headphones to the [PHONES] terminal.**

For instructions on connections, see *Connecting the input/output terminals* on page 10.

2 Press the [🎧 (CH1)] or [🎧 (CH2)] button.

Select the channel you want to monitor.

- This operation is not necessary to monitor the sound output from the [MASTER OUT 1] and [MASTER OUT 2] terminals (the sound of the master channel).

3 Turn the [HEADPHONES MIXING] control.

— When turned counterclockwise: The volume of [CH 1] and [CH 2] becomes relatively louder.

- At the center position: The volume of the [CH 1] and [CH 2] sound is the same as the volume of the sound output from the [MASTER OUT 1] and [MASTER OUT 2] terminals (the sound of the master channel).
- When turned clockwise: The volume of the sound output from the [MASTER OUT 1] and [MASTER OUT 2] terminals (the sound of the master channel) becomes relatively louder.

4 Turn the [HEADPHONES LEVEL] control.

Sound is output from the headphones.

- When the [🎧 (CH1)] button or [🎧 (CH2)] button is pressed again, monitoring is canceled.
- Monitoring of the sound output from the [MASTER OUT 1] and [MASTER OUT 2] terminals (the sound of the master channel) cannot be canceled.

Using a microphone**1 Press the [MIC (ON/OFF)] button.****2 Turn the [MIC LEVEL] control clockwise.**

The sound of the microphone is output from the speakers.

❖ Adjusting the sound quality**Turn the [MIC EQ] control.**

- When turned fully clockwise, the attenuation of the bass sound is maximum.
- When turned fully counterclockwise, the attenuation of the treble sound is maximum.

Using the AUX function**1 Press the [AUX (ON/OFF)] button.****2 Turn the [AUX LEVEL] control.**

Adjusts the audio level input to the [AUX IN] terminals.

Audio is output from the [BOOTH] terminal**Turn the [BOOTH MONITOR] control.**

Adjusts the level of audio signals output from the [BOOTH] terminal.

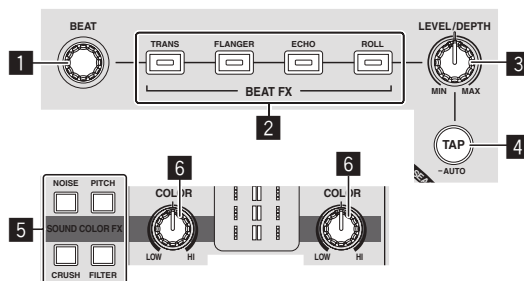
Effect section**1 BEAT control**

Selects the beat multiple for synchronizing the beat effect.

2 BEAT FX (TRANS, FLANGER, ECHO, ROLL) buttons

These turn the respective beat effects on and off.

3 LEVEL/DEPTH control

Adjusts the quantitative parameter of the beat effect.

4 TAP (AUTO) button

Switches the BPM measurement mode.

- AUTO mode: The [TAP (AUTO)] button turns off and the BPM is measured automatically from the audio signal being input. The [AUTO] mode is set when this unit's power is turned on.
- TAP mode: The [TAP (AUTO)] button lights and the BPM is input manually by tapping the [TAP (AUTO)] button. When the [TAP (AUTO)] button is pressed, the TAP mode is set.
 - The BPM measuring range in the AUTO mode is BPM = 70 – 180. For some tracks, it may not be possible to measure the BPM correctly.
 - BPMs set in the TAP mode are only valid for the BEAT FX function.

5 SOUND COLOR FX (NOISE, PITCH, CRUSH, FILTER) buttons

These turn the respective SOUND COLOR FX on and off.

6 COLOR control

This changes the parameters of the SOUND COLOR FX of the different channels.

Using the beat effect function

This unit is equipped with four effect buttons. Effects can be applied to the sound by pressing one of the effect buttons.

Press one of the [BEAT FX (TRANS, FLANGER, ECHO, ROLL)] buttons.

The button that was pressed flashes.

The effect is applied in beat with the track.

The effect differs for the different buttons. For details on the different effects, see the table below.

- When a button that is flashing is pressed again, the effect is turned off.

Effect Name	Descriptions	LEVEL/DEPTH
TRANS	Cuts the sound according to the beat multiple set with the [BEAT] control.	Sets the balance between the original sound and the effect sound.
FLANGER	Creates a one-cycle flanger effect according to the beat multiple set with the [BEAT] control.	The further the control is turned clockwise, the more the effect is stressed.
ECHO	Outputs a delay sound several times that attenuates gradually according to the beat multiple set with the [BEAT] control. With 1/1 beat echoes, the delay sounds are faded out according to the track's tempo even after the input sound has been cut.	Use this to set the balance between the original sound and the echo sound.
ROLL	Records the input sound at the point the [ROLL] button is pressed and repeatedly outputs the recorded sound according to the beat multiple set with the [BEAT] control.	Sets the balance between the original sound and the roll sound.

❖ Varying the effect

Turn the [LEVEL/DEPTH] control.

The effect changes according to the direction in which the [LEVEL/DEPTH] control is turned and its position.

Inputting the BPM manually

1 Press the [TAP (AUTO)] button.

The [TAP (AUTO)] button lights and the mode switches to the TAP mode.

2 Tap the [TAP (AUTO)] button at least 2 times in rhythm with the beat (in quarter notes) of the sound being played.

The average value of the interval at which the [TAP (AUTO)] button is tapped with a finger is displayed in the auto loop/effect display section.

- To set the mode back to AUTO, press the [TAP (AUTO)] button for over 1 second.

SOUND COLOR FX

These effects change in association with the [COLOR] controls for the different channels.

1 Press one of the [SOUND COLOR FX (NOISE, PITCH, CRUSH, FILTER)] buttons.

This selects the type of effect.

The button that was pressed flashes.

- For the types of effects, see *Types of SOUND COLOR FX effects*.
- The same effect is set for [CH 1] and [CH 2].

2 Turn the [COLOR] control.

The effect is applied to the channel(s) for which the control(s) was (were) pressed.

❖ Types of SOUND COLOR FX effects

Effect Name	Descriptions	[COLOR] control
PITCH	Changes the musical interval within the range of 1 octave up and down.	Turn counterclockwise: The pitch decreases. Turn clockwise: The pitch increases.
NOISE	White noise generated inside this unit is mixed in to the sound of the channel via the filter and output. <ul style="list-style-type: none"> • The volume can be adjusted by turning the [TRIM] controls for the respective channels. The sound quality can be adjusted by turning the [EQ (HI, MID, LOW)] controls. 	Turn counterclockwise: The cut-off frequency of the filter through which the white noise passes gradually decreases. Turn clockwise: The cut-off frequency of the filter through which the white noise passes gradually increases.
CRUSH	Changes the original sound to a crushed-like sound for output.	Turn counterclockwise: Increases the sound's distortion. Turn clockwise: The sound is crushed before passing through the high pass filter.
FILTER	Outputs sound that has passed through a filter.	Turn counterclockwise: Gradually decreases the low-pass filter's cutoff frequency. Turn clockwise: Gradually increases the high-pass filter's cutoff frequency.

Operation

Turning the power on

1 Make all the connections, then plug the power cord into a power outlet.

⇒ *Connections* (p.10)

2 Press the [STANDBY/ON] button.

The [STANDBY/ON] indicator lights green.

To set to the standby mode

When this unit's power is on, press the [STANDBY/ON] button for over 1 second.

This unit is set to the standby mode.

The [STANDBY/ON] indicator lights red.

- When the [STANDBY/ON] button is pressed again, the power turns on.
- This unit is equipped with an auto standby function. For details, see *About the auto standby function* on page 24.
- Do not disconnect the USB device or turn off this unit's power while the USB indicator is lit or flashing. Doing so could delete this unit's management data and damage the USB device, making it impossible to read.

Loading and ejecting discs

- This unit is a one-disc player. Do not insert multiple disc.
- Do not force discs into the disc insertion slot when this unit's power is off. Doing so could damage the disc and lead to malfunction of this unit.

Inserting discs

Insert the disc horizontally into the disc insertion slot, with the printed surface facing up.

Playback starts after the medium's information has been read.

- When a disc containing music files recorded with a hierarchical structure is loaded, playback starts from the tracks in the uppermost layer.

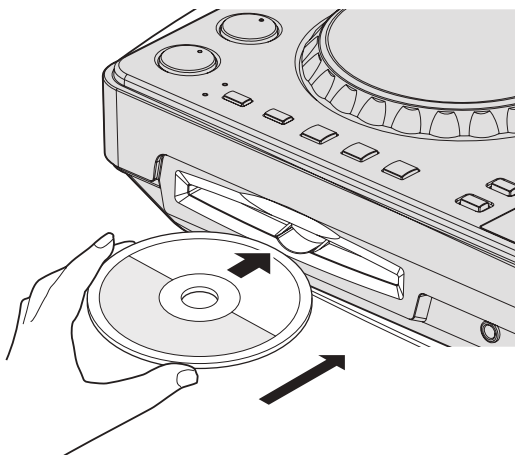

- When auto cue is turned on, the disc pauses at the audio start position. In this case, press the [PLAY/PAUSE▶/II] to start playback. For details on auto cue, see *Setting auto cue* on page 18.

Ejecting discs

1 Press the [▶/II (PLAY/PAUSE)] button during playback, or if a cue point is set, press the [CUE] button during playback (back cue), then press the [DISC▲] button to eject the disc.

When the button is pressed, disc rotation stops and the disc comes out of the disc insertion slot.

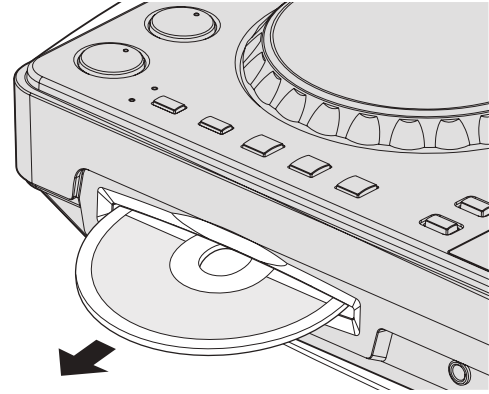

2 Pull the disc out, being careful not scratch its signal surface.

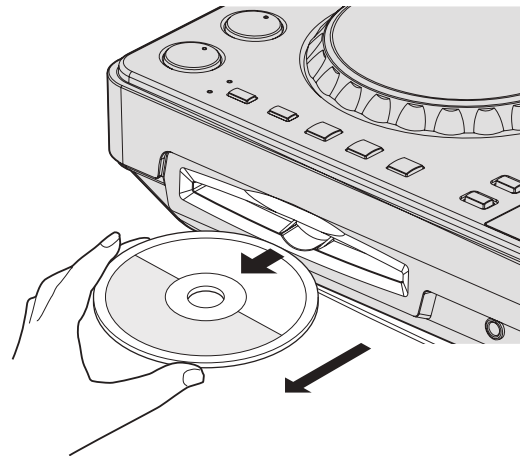

- If the [DISC▲] button is pressed accidentally, press the [▶/II (PLAY/PAUSE)] button immediately. Disc ejection is canceled and the unit is reset to as it was directly before the [DISC▲] button was pressed. (No sound is output during the resetting process.)

⚠ CAUTION

When the disc is being drawn in or ejected, do not apply any force to the disc in the direction opposite its movement. Doing so could damage the disc or this unit.

❖ About the resume function

If a disc is ejected while paused then that same disc is reinserted, the disc pauses at the playback position it was at when it was ejected. This position is stored in the memory until the unit's power is turned off or a different disc is loaded.

- This function does not work with storage devices (USB).

Connecting and disconnecting USB devices

Connecting USB devices

Connect the USB device to the USB device insertion slot.

Disconnecting USB devices

1 Press the [USB STOP] button for over 2 seconds, until the USB indicator turns off.

Do not disconnect the USB device or turn off this unit's power while the USB indicator is lit or flashing. Doing so could delete this unit's management data and damage the USB device, making it impossible to read.

2 Disconnect the USB device.

Playback

This section describes basic track selection operations and how to switch the screen.

Playing media connected to or inserted in this unit

1 Load the medium in this unit.

- *Inserting discs* (p.21)
- *Connecting USB devices* (p.22)

2 Press the corresponding medium button ([CD] or [USB]).

The tracks or folders are displayed on a list.

The medium whose contents are displayed on the main unit display can be switched.

[CD] button: Displays the contents on the inserted disc.

[USB] button: Displays the contents on the connected USB device.

- If tracks are loaded from another medium, a warning message is displayed. Check the message, then press the rotary selector. The warning message turns off and the medium is switched.
- If the storage device (USB) contains rekordbox library information, the rekordbox library is displayed.
- When a link is established with remotebox, the contents of the USB device are displayed on the mobile device, not on this unit.

3 Turn the rotary selector.

Move the cursor and select the item.

- Press the rotary selector to move to a lower level in the folder. Press the [BACK] button to return to the level above.
- When the [BACK] button is pressed for over 1 second or the medium button for the medium being browsed is pressed, the display moves to the topmost level.

4 Select the track and press the rotary selector.

When the track is loaded, the screen switches to the information display mode.

The track is loaded, playback starts, and the corresponding medium button flashes.

- When a track has been loaded while pausing, press the [PLAY/PAUSE▶/II] button to start playback.
- When auto cue is turned on, the disc pauses at the audio start position. In this case, press the [PLAY/PAUSE▶/II] to start playback. For details on auto cue, see *Setting auto cue* on page 18.

❖ If the medium contains the rekordbox library

If the USB device connected to this unit contains the rekordbox library information, the rekordbox library is displayed.

- Music files are displayed in the categories (album, artist, etc.) set with rekordbox.
-

Using remotebox

Tracks on USB devices connected to this unit can be browsed and loaded from mobile devices via wireless LAN.

1 Connect the mobile device by wireless LAN.

2 Launch remotebox on the mobile device and establish the link.

3 Connect the USB device to this unit's USB device insertion slot.

4 Operate remotebox on the mobile device to select the track.

5 Operate remotebox on the mobile device to select the deck on which the track is to be loaded, then tap.

Track loading starts. The jog dial indicator on the deck on which the track is being loaded flashes.

Once playback is possible, the jog dial indicator stops flashing, remaining lit, the track name is displayed on the main unit display and playback starts.

- Also see the remotebox operating instructions.
-

Outputting sound

Before outputting sound, check that this unit and the surrounding devices are properly connected. For instructions on connecting, see *Connecting the input/output terminals* on page 10 or *Connecting by wireless LAN* on page 11.

Set the volume of the power amplifier or powered speakers connected to the [MASTER OUT 1] and [MASTER OUT 2] terminals to an appropriate level. Note that loud sound may be output if the volume is set too high.

To output the sound of channel 1 [CH 1]

To output the sound of [CH 2] (channel 2), replace [CH 1] with [CH 2], [DECK 1] with [DECK 2] and [PHONO1/LINE1] with [PHONO2/LINE2] in the procedure below.

1 Switch the [DECK 1, PHONO1/LINE1] selector switch in the [CH 1] section.

Select the input source for [CH 1] from among the devices connected to this unit.

- [DECK 1]: Selects the USB device, CD or MIDI.
- [PHONO1/LINE1]: Selects the device connected to the [PHONO1/LINE1] terminals.

2 Turn the [TRIM] control in the [CH 1] section clockwise.

Adjusts the audio level input to the [CH 1] terminal.

The [LEVEL] indicator lights when sound is properly being input to [CH 1].

Adjust the [TRIM] control so that the orange indicator lights where the track's volume is highest (at the climax, etc.)

Be careful that the red indicator does not light, or the sound could be distorted.

3 Move the [CH 1] channel fader to the back side.

The level of the sound output from the [CH 1] terminals is adjusted.

4 Switch [CROSS F. CURVE THRU, ㄨ, ㄨ] (the crossfader curve selector switch).

This switches the crossfader curve characteristics.

- [THRU]: Choose this when you do not want to use the crossfader.
-

- : Set here for a curve that rises gradually.
- : Set here for a curve that rises steeply. (When the crossfader moves away from either the left or right edge, the sound is immediately output from the opposite side.)

5 Set the crossfader.

Switch the channel whose sound is output from the speakers.

- Left edge: The [CH 1] sound is output.
- Center position: The sound of [CH 1] and [CH 2] is mixed and output.
- Right edge: The [CH 2] sound is output.
- This operation is not necessary when the [CROSS F. CURVE (THRU, ,) selector switch is set to [THRU].

6 Turn the [MASTER LEVEL] control clockwise.

Sound is output from the speakers.

The [LEVEL] indicator lights.

Adjust the [MASTER LEVEL] control so that the orange indicator lights where the track's volume is highest (at the climax, etc.).

Be careful that the red indicator does not light, or the sound could be distorted.

Mixing using the faders

Prepare the unit in advance so that the sound of [CH 1] is being output from the speakers. For instructions on preparation, see *Outputting sound* on page 22.

For instructions on monitoring the sound, see *Monitoring sound with headphones* on page 19.

Mixing using the channel faders

1 Set [CROSS F. CURVE THRU, ,] (the crossfader curve selection switch) to [THRU].

2 Switch the [DECK 2, PHONO2/LINE2] selector switch in the [CH 2] section.

3 Turn the [TRIM] control in the [CH 2] section clockwise.

4 Press the (CH2) button.

The sound of [CH 2] is monitored from the headphones.

5 Turn the [HEADPHONES MIXING] control.

This adjusts the balance of the monitor volume between the sound output from the [MASTER OUT 1] and [MASTER OUT 2] terminals (the sound of [CH 1]) and the sound of [CH 2].

6 Operate [DECK 2].

While checking the sound over the headphones, adjust the tempo of [CH 2] track to match the tempo of [CH 1] track.

7 While moving the [CH 2] channel fader to the back, move the [CH 1] channel fader to the front.

While checking the sound output from the speakers, operate the channel faders to substitute the sound of [CH 1] with the sound of [CH 2]. Mixing is completed once only the [CH 2] sound is being output from the speakers.

Mixing using the crossfader

1 Set [CROSS F. CURVE THRU, ,] (the crossfader curve selector switch) to or .

2 Operate [CH 2].

Perform steps 2 to 6 at *Mixing using the channel faders* above.

3 Move the crossfader gradually to the right.

While checking the sound output from the speakers, operate the crossfader to substitute the sound of [CH 1] with the sound of [CH 2].

Mixing is completed once only the [CH 2] sound is being output from the speakers.

Using the QUANTIZE function

This function can be used to play auto beat loops, apply beat effects, etc., in tempo with the currently playing track based on the track's GRID information as analyzed with rekordbox.

- Music files must be analyzed ahead of time with rekordbox in order to use the QUANTIZE function. For instructions on analyzing music files with rekordbox, see the rekordbox Operating Instructions.

Press the [TIME (AUTO CUE, QUANTIZE)] button while pressing the [SHIFT] button.

The QUANTIZE function turns on.

When the QUANTIZE function is turned on, the points are automatically set to the nearest beat position when auto beat loops, beat effects, cues or hot cues are set.

Furthermore, the auto beat loop, beat effect, hot cue and other functions can be used without breaking the beat.

- When the [TIME (AUTO CUE, QUANTIZE)] button is pressed again while pressing the [SHIFT] button, the QUANTIZE function turns off.

Using the SYNC function

This function can be used to automatically synchronize the tempo (BPM) and beat positions on the left and right decks based on the tracks' GRID information as analyzed with rekordbox.

- Music files must be analyzed ahead of time with rekordbox in order to use the SYNC function. For instructions on analyzing music files with rekordbox, see the rekordbox Operating Instructions.
- The following describes the procedure for synchronizing the [DECK 2] track to the [DECK 1] track.

1 Play a track that has been analyzed with rekordbox on [DECK 1].

The deck on which a track that has been analyzed with rekordbox is played first is set as the MASTER for the SYNC function.

- The master can also be specified by pressing the [MASTER] button.

2 Play a track that has been analyzed with rekordbox on [DECK 2].

3 Press the [SYNC] button for [DECK 2].

[DECK 2] is synchronized to the tempo (BPM) and beat positions of the track playing on [DECK 1].

- When the [SYNC] button is pressed again, the SYNC function turns off.
- Use the procedure below to restore the currently playing track's tempo (BPM) to its original tempo after turning the SYNC function off.
 - First move the [TEMPO] slider to the position to which the tempo (BPM) was synchronized (the [TEMPO] indicator turns off), then move it back to the center position.
 - Reload the same track.
- Depending on the track's beat information, the sound may not be synchronized after the [SYNC] button is pressed. If this happens, the sound can be re-synchronized by pressing the [SYNC] button to turn the sync mode off then back on.

Changing the settings

1 Press the [INFO(UTILITY)] button for over 1 second.
The [UTILITY] screen is displayed.

2 Use the rotary selector to change the setting.

- When the [BACK (TOP)] button is pressed, the previous screen reappears.

3 Press the rotary selector.

The changed settings are stored.

- To close the [UTILITY] screen, press the [INFO(UTILITY)] button.

About the auto standby function

When the auto standby function is turned on, the power is automatically set to the standby mode after the set time has passed with all of the conditions below met.

- That none of this unit's buttons or controls are operated.
- That this unit's channel level indicator is not lit.
- That the playback function is not operating.
- That no computer is connected to the USB terminal (Type B terminal) on this unit's rear panel.
- That remotebox is not connected to this unit.
- That the demo mode is turned off.

Setting preferences

Options settings	Selection items	Descriptions
WLAN INFO	—	For details, see <i>List of WLAN INFORMATION items</i> below.
WLAN SETTING	—	For details, see <i>List of WLAN SETTING items</i> on page 25.
MIXER MODE	XDJ-R1*/PC	For details, see <i>Changing the [MIXER MODE]</i> on page 27.
A. CUE LEVEL	-36 dB/-42 dB/-48 dB/-54 dB/-60 dB*/-66 dB/-72 dB/-78 dB	Sets the auto cue level. For instructions on setting, see <i>Changing the auto cue level</i> on page 18.
SAMPLE LEVEL	1 - 50* - 100	Adjusts the volume of the sampled sound sources.
CROSS FADER START	ON/OFF*	Playback starts from the cue point when the crossfader is moved.
TOUCH SENSE LEVEL(DECK1)	-4 - 0* - +4	Adjusts the sensitivity of the [DECK 1] jog dial.
TOUCH SENSE LEVEL(DECK2)	-4 - 0* - +4	Adjusts the sensitivity of the [DECK 2] jog dial.
BACK UP	SAVE/LOAD	Loads the disc's hot cue information stored in this unit.
AUTO STANDBY	OFF/20 min*/40 min/60 min	Set the time until the standby mode is set. For details, see <i>About the auto standby function</i> above.
DEMO MODE	ON/OFF*	Turns the demo mode on and off.
VERSION No.	—	Displays this unit's software version.

*: Setting upon purchase

List of WLAN INFORMATION items

When [MODE] at [WLAN SETTING] is set to [OFF], only [MODE] and [MAC ADDRESS] are displayed.

Item	
MODE	Displays the operation mode of this unit's wireless LAN function.
SSID	Displays this unit's [SSID].
SECURITY	Displays the currently set security (encryption) type.
PASSWORD	Displays the currently set password.
IP ADDRESS	192.168.2.3 is displayed.
SUBNET MASK	255.255.255.0 is displayed.
CONNECTED CLIENTS	Displays the MAC addresses of clients connected by WLAN.
MAC ADDRESS	Displays this unit's MAC address.

List of WLAN SETTING items

When [MODE] at [WLAN SETTING] is set to [OFF], only [MODE] and [RESET TO DEFAULT] are displayed.

Setting item 1	Setting item 2	Setting ranges	Description
MODE	—	ENABLE*/DISABLE	Used to set this unit's operation mode.
NETWORK SETTING	SSID	A to Z, a to z, 0 to 9, symbols (max. 32 characters)	Used to set this unit's [SSID].
	SECURITY	OPEN / WEP64 / WEP128*	Used to set this unit's security (encryption) type.
	PASSWORD	A to Z, a to z, 0 to 9, symbols (5 characters for [WEP64], 13 characters for [WEP128])	Used to set this unit's password.
OTHERS	CHANNEL NO.	CH1 – 11, AUTO*	This unit uses the 2.4 GHz band. If there is a wireless LAN network on the same band in the area and the waves cause interference, making connections and communications instable, try changing the channel manually. (By default, this is set to [AUTO] and a relatively free channel is selected automatically.)
	DHCP SERVER	ENABLE*/DISABLE	Used to set whether or not to enable this unit's DHCP server function. [ENABLE]: Enables the DHCP server function. [DISABLE]: Disables the DHCP server function.
RESET TO DEFAULT	—	YES/NO	Resets the settings at [WLAN SETTING] to the factory defaults.

*: Setting upon purchase

Using the DJ software

About the driver software (Windows)

This driver software is an exclusive ASIO driver for outputting audio signals from the computer.

- There is no need to install the driver software when using Mac OS X.

Operating environment

Supported operating systems		
Windows® 8/Windows® 8 Pro	32-bit version	✓
	64-bit version	✓ ^[1]
Windows® 7 Home Premium/Professional/Ultimate	32-bit version	✓
	64-bit version	✓ ^[1]
Windows Vista® Home Basic/Home Premium/Business/Ultimate	32-bit version	✓
	64-bit version	✓ ^[1]
Windows® XP Home Edition/Professional (SP2 or later)	32-bit version	✓

[1] When using a 64-bit version of Windows, the driver software can only be used for 32-bit applications.

Before installing the driver software

- First read the *Software end user license agreement* on page 6 carefully.
- Turn off this unit's power switch, then disconnect the USB cable connecting this unit and the computer.
- If any other programs are running on the computer, quit them.
- To install or uninstall the driver software, you need to be authorized by the administrator of your computer. Log on as the administrator of your computer before proceeding with the installation.
- If you connect this unit to your computer without installing the driver software first, an error may occur on your computer depending on the system environment.
- If installation of the driver software is interrupted after it has started, start the installation procedure over again from the beginning.

Installing the driver software

1 Turn on the computer's power.

2 Insert the included CD-ROM into the computer's CD drive.

3 When the CD-ROM menu appears, select [Install Driver Software (Pioneer_XDJ_R1_Driver_X.XXX)], then click [Start].

4 Proceed with installation according to the instructions on the screen.

If [Windows Security] appears on the screen while the installation is in progress, click [Install this driver software anyway] and continue with the installation.

- When installing on Windows XP
If [Hardware Installation] appears on the screen while the installation is in progress, click [Continue Anyway] and continue with the installation.
- When the installation program is completed, a completion message appears.

Connecting this unit and computer

1 Connect this unit to your computer via a USB cable.

For instructions on connections, see *Connecting the input/output terminals* on page 10.

2 Press the [STANDBY/ON] button.

Turn on the power of this unit.

- The message [Installing device driver software] may appear when this unit is first connected to the computer or when it is connected to a different USB port on the computer. Wait a while until the message [Your devices are ready for use] appears.

Adjusting the buffer size

This unit functions as an audio device conforming to the ASIO standards.

- If an application using this unit as the default audio device (DJ software, etc.) is running, quit that application before adjusting the buffer size.

Click the Windows [Start] menu>[All Programs]>[Pioneer]>[XDJ_R1]>[XDJ_R1 ASIO Settings Utility].

- For Windows 8, click [XDJ_R1 ASIO Settings Utility] from the [Start] menu.

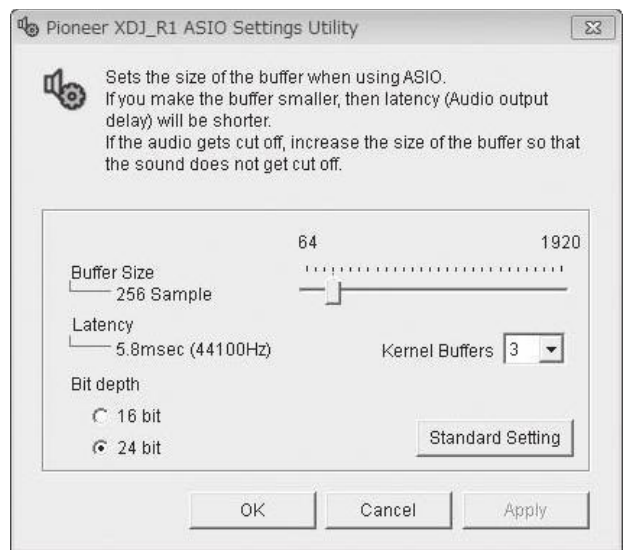

- If the buffer size is made large, drops in audio data (breaks in the sound) occur less easily, but the time lag due to the delay in the transfer of the audio data (latency) increases.
- If the kernel buffer number is made large, breaks in the sound occur less easily, but the time lag due to latency increases.
- Operate referring to the procedure below to adjust the buffer size and kernel buffer.

If there are no interruptions in the sound with the default settings

- ① Gradually decrease the buffer size, setting it to the minimum value at which there are no interruptions in the sound.
- ② Set the kernel buffer size to [2] and check whether there are interruptions in the sound.
— If there are interruptions in the sound, set the kernel buffer size to [3].

If there are interruptions in the sound with the default settings

- ① Set the kernel buffer size to [4], then set the buffer size to the minimum value at which there are no interruptions in the sound.

Checking the version of the driver software

Click the Windows [Start] menu>[All Programs]>[Pioneer]>[XDJ_R1]>[XDJ_R1 Version Display Utility].

- For Windows 8, click [XDJ_R1 Version Display Utility] from the [Start] menu.

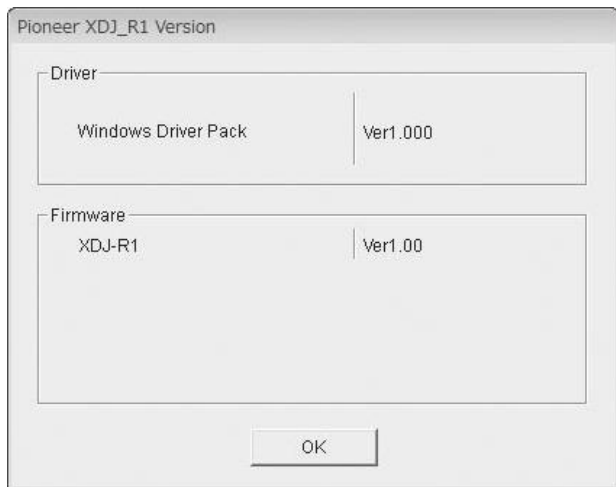

- You can check the firmware version of this unit on the screen.
- The firmware version is not displayed when this unit is not connected to the computer or when this unit and computer are not properly communicating.

Checking the latest information on the driver software

For the latest information on the driver software for exclusive use with this unit, visit our website shown below.
<http://pioneerdj.com/support/>

Using the DJ software

This unit also outputs the information concerning VIRTUAL DJ LE operations as well as operations of the buttons and controls in universal MIDI format. When a computer on which a MIDI-compatible DJ software program is installed is connected using a USB cable, the DJ software can be operated from this unit. The sound of music files being played on the computer can also be output from this unit.

To use this unit as an audio device, install the driver software on the computer beforehand (page 26). This unit must also be selected in the DJ software's audio output device settings. For details, see your DJ software's operating instructions.

1 Connect the USB port on this unit to your computer.

For instructions on connections, see *Connecting the input/output terminals* on page 10.

2 Press the [MIDI] button.

[MIDI CONTROL] appears on the main unit display.

- If tracks are loaded from another medium, a warning message is displayed. Check the message, then press the rotary selector. The warning message turns off and the medium is switched.

3 Launch the DJ software.

Communication with the DJ software starts.

The DJ software can be operated using this unit's buttons and controls.

- It may not be possible to use some buttons to operate the DJ software.
- For messages output by this unit, see *List of MIDI Messages* on page 28.

Changing the [MIXER MODE]

There are two types of DJ software mixing modes, one for mixing using an external mixer and one for mixing within the DJ software. On this unit, either mixing mode can be used by changing the [MIXER MODE] setting on the [UTILITY] screen.

1 Press the [INFO(UTILITY)] button for over 1 second.

The [UTILITY] screen is displayed.

2 Turn the rotary selector, select [MIXER MODE], then press the rotary selector.

3 Turn the rotary selector, select the mode you want to set, then press the rotary selector.

- [XDJ-R1]: The sound is mixed using this unit's mixer section. The DJ software can be operated using this unit's player section.
- [PC]: The sound is mixed within the DJ software.

Set the DJ software's audio output settings as described below.

PIONEER XDJ-R1MASTER/CH1 L

PIONEER XDJ-R1MASTER/CH1 R

PIONEER XDJ-R1PHONES/CH2 L

PIONEER XDJ-R1PHONES/CH2 R

- To close the [UTILITY] screen, press the [INFO(UTILITY)] button.

Using VIRTUAL DJ LE

About the VIRTUAL DJ LE software

VIRTUAL DJ LE is a DJ software application by Atomix productions. DJ performances are possible by connecting the computer on which this software is installed to this unit.

Installing the VIRTUAL DJ LE software

The VIRTUAL DJ LE software must be downloaded from the Atomix productions website.

For instructions on launching VIRTUAL DJ LE and the table of supported functions, please visit the following website:

<http://pioneerdj.com/support/>

For the latest information on the operating environment and compatibility, and to acquire the latest operating system, please visit the following Atomix productions website:

<http://www.virtualdj.com/>

Note on using an Internet connection

- A separate contract with and payment to a provider offering Internet services is required.

List of MIDI Messages

Of the three bytes of MIDI messages, the first and third bytes are expressed in hexadecimal, the second byte in decimal.

	MIDI channel	MIDI ch. Value
Deck A	1	n=0
Deck B	2	n=1
Deck C	3	n=2
Deck D	4	n=3
Effect A/C	5	n=4
Effect B/D	6	n=5
Mixer	7	n=6

1 Player



SW Name		MIDI message (this unit to computer)					Remarks (dd values)		
		When SHIFT button is off			When SHIFT button is on				
Rotary selector (SELECT PUSH) (turn)		Bn	64	dd	Bn	65	dd	Difference count value from when previously operated • Turn clockwise: 1 – (max) 30 • Turn counterclockwise: 127 – (min) 98	
Rotary selector (SELECT PUSH) (press)		9n	66	dd	9n	67	dd	OFF=0, ON=127	
BACK button		9n	68	dd	9n	69	dd	OFF=0, ON=127	
TIME (AUTO CUE, QUANTIZE) button		9n	62	dd	9n	63	dd	OFF=0, ON=127	
PLAY/PAUSE button		9n	11	dd	9n	71	dd	OFF=0, ON=127	
CUE button		9n	12	dd	9n	72	dd	OFF=0, ON=127	
TRACK SEARCH ►► button		9n	9	dd	9n	74	dd	OFF=0, ON=127	
TRACK SEARCH ◀◀ button		9n	10	dd	9n	75	dd	OFF=0, ON=127	
AUTO BEAT LOOP control (turn)	XDJ-R1	Bn	19	dd	Bn	79	dd	Difference count value from when previously operated • Turn clockwise: 1 – (max) 30 • Turn counterclockwise: 127 – (min) 98	
	From remotebox	32 beats	9n	110	dd	—	—	—	OFF=0, ON=127
		16 beats	9n	111	dd				
		8 beats	9n	112	dd				
		4 beats	9n	113	dd				
		2 beats	9n	114	dd				
		1 beat	9n	115	dd				
		1/2 beat	9n	116	dd				
		1/4 beat	9n	117	dd				
		1/8 beat	9n	118	dd				
1/16 beat	9n	119	dd						
1/32 beat	9n	120	dd						
AUTO BEAT LOOP control (press)		9n	20	dd	9n	80	dd	OFF=0, ON=127	
MODE (HOT CUE/4-BEAT SAMPLER) button		9n	59	dd	9n	60	dd	OFF=0, ON=127	
CALL button		9n	25	dd	9n	85	dd	OFF=0, ON=127	
HOT CUE/DELETE A button		9n	46	dd	9n	95	dd	OFF=0, ON=127	
HOT CUE/DELETE B button		9n	47	dd	9n	96	dd	OFF=0, ON=127	
HOT CUE/DELETE C button		9n	48	dd	9n	97	dd	OFF=0, ON=127	
4-BEAT SAMPLER A button		9n	50	dd	9n	99	dd	OFF=0, ON=127	
4-BEAT SAMPLER B button		9n	51	dd	9n	100	dd	OFF=0, ON=127	
4-BEAT SAMPLER C button		9n	52	dd	9n	101	dd	OFF=0, ON=127	
VINYL MODE button		9n	21	dd	9n	22	dd	OFF=0, ON=127	
MASTER TEMPO button		9n	26	dd	9n	86	dd	OFF=0, ON=127	
TEMPO RANGE button	6 %	9n	14	dd	9n	87	dd	OFF=0, ON=127	
	10 %	9n	15	dd					
	16 %	9n	16	dd					
	WIDE	9n	17	dd					
TEMPO slider		Bn	0	MSB	Bn	5	MSB	0–16383	
		Bn	32	LSB	Bn	37	LSB	0 at – side, 16383 at + side	
SYNC button		9n	88	dd	9n	92	dd	OFF=0, ON=127	
MASTER button		9n	89	dd	9n	93	dd	OFF=0, ON=127	

SW Name	MIDI message (this unit to computer)						Remarks (dd values)
	When SHIFT button is off			When SHIFT button is on			
Jog dial (when outer section turned)	Bn	1	dd	Bn	6	dd	Difference count from previous operation <ul style="list-style-type: none"> Increases from 64 when turned clockwise, decreases from 64 when turned counterclockwise. The cumulative differential count when the jog dial is turned one rotation is 600.
Jog dial (when top section turned)	Bn	2	dd	Bn	7	dd	Difference count from previous operation <ul style="list-style-type: none"> Increases from 64 when turned clockwise, decreases from 64 when turned counterclockwise. The cumulative differential count when the jog dial is turned one rotation is 600.
Jog dial (when top section pressed)	9n	54	dd	9n	103	dd	OFF=0, ON=127

Names of switches and indicators		MIDI message (computer to this unit)						Remarks (dd values)
		When SHIFT button is off			When SHIFT button is on			
Deck switching	Deck C→A	90	62	dd	—	—	—	[DeckA] displayed in the [DECK 1] information display section: 127
	Deck D→B	91	62	dd	—	—	—	[DeckB] displayed in the [DECK 2] information display section: 127
	Deck A→C	92	62	dd	—	—	—	[DeckC] displayed in the [DECK 1] information display section: 127
	Deck B→D	93	62	dd	—	—	—	[DeckD] displayed in the [DECK 2] information display section: 127
PLAY/PAUSE button		9n	11	dd	9n	71	dd	Off = 0, lit = 127
CUE button		9n	12	dd	9n	72	dd	Off = 0, lit = 127
TRACK SEARCH ►► button		9n	9	dd	9n	74	dd	OFF=0, ON=127
TRACK SEARCH ◄◄ button		9n	10	dd	9n	75	dd	OFF=0, ON=127
VINYL MODE button		9n	21	dd	9n	22	dd	Off = 0, lit = 127
AUTO BEAT LOOP control (turn)	32 beats	9n	110	dd	9n	79	dd	OFF=0, ON=127
	16 beats	9n	111	dd				
	8 beats	9n	112	dd				
	4 beats	9n	113	dd				
	2 beats	9n	114	dd				
	1 beat	9n	115	dd				
	1/2 beat	9n	116	dd				
	1/4 beat	9n	117	dd				
	1/8 beat	9n	118	dd				
	1/16 beat	9n	119	dd				
1/32 beat	9n	120	dd					
AUTO BEAT LOOP indicator		9n	20	dd	9n	80	dd	Off = 0, lit = 127
HOT CUE/4-BEAT SAMPLER indicator		9n	59	dd	9n	60	dd	HOT CUE indicator off and 4-BEAT SAMPLER indicator lit = 0 HOT CUE indicator lit and 4-BEAT SAMPLER indicator off = 127
MASTER TEMPO button		9n	26	dd	9n	86	dd	Off = 0, lit = 127
TEMPO ▲ indicator		9n	28	dd	—	—	—	Off = 0, lit = 127
TEMPO ▼ indicator		9n	29	dd	—	—	—	Off = 0, lit = 127
TEMPO RANGE button	6 %	9n	14	dd	9n	87	dd	OFF=0, ON=127
	10 %	9n	15	dd				
	16 %	9n	16	dd				
	WIDE	9n	17	dd				
TEMPO slider		Bn	0	dd	Bn	5	dd	0-127 0 at – side, 127 at + side
MASTER button		9n	89	dd	9n	93	dd	Off = 0, lit = 127
SYNC button		9n	88	dd	9n	92	dd	Off = 0, lit = 127
CALL button		9n	25	dd	9n	85	dd	Off = 0, lit = 127
HOT CUE/DELETE A button		9n	46	dd	9n	95	dd	Off = 0, lit = 127
HOT CUE/DELETE B button		9n	47	dd	9n	96	dd	Off = 0, lit = 127
HOT CUE/DELETE C button		9n	48	dd	9n	97	dd	Off = 0, lit = 127
4-BEAT SAMPLER A button		9n	50	dd	9n	99	dd	Off = 0, lit = 127
4-BEAT SAMPLER B button		9n	51	dd	9n	100	dd	Off = 0, lit = 127
4-BEAT SAMPLER C button		9n	52	dd	9n	101	dd	Off = 0, lit = 127
Jog dial illumination (4-point lighting)		9n	55	dd	9n	56	dd	Off = 0, lit = 127

2 Mixer

SW Name		MIDI message (this unit to computer)						Remarks (dd values)
		When SHIFT button is off			When SHIFT button is on			
MASTER LEVEL control		B6 B6	0 32	MSB LSB	— —	— —	— —	0-16383 When turned fully counterclockwise: 0 / When turned fully clockwise: 16383
MIC LEVEL control		B6 B6	20 52	MSB LSB	— —	— —	— —	0-16383 When turned fully counterclockwise: 0 / When turned fully clockwise: 16383
MIC EQ control		B6 B6	22 54	MSB LSB	— —	— —	— —	0-16383 When turned fully counterclockwise: 0 / When turned fully clockwise: 16383
AUX LEVEL control		B6 B6	24 56	MSB LSB	— —	— —	— —	0-16383 When turned fully counterclockwise: 0 / When turned fully clockwise: 16383
BOOTH MONITOR control		B6 B6	26 58	MSB LSB	— —	— —	— —	0-16383 When turned fully counterclockwise: 0 / When turned fully clockwise: 16383
TRIM control	Deck A	B6 B6	3 35	MSB LSB	— —	— —	— —	0-16383 When turned fully counterclockwise: 0 / When turned fully clockwise: 16383
	Deck B	B6 B6	4 36	MSB LSB	— —	— —	— —	0-16383 When turned fully counterclockwise: 0 / When turned fully clockwise: 16383
	Deck C	B6 B6	5 37	MSB LSB	— —	— —	— —	0-16383 When turned fully counterclockwise: 0 / When turned fully clockwise: 16383
	Deck D	B6 B6	6 38	MSB LSB	— —	— —	— —	0-16383 When turned fully counterclockwise: 0 / When turned fully clockwise: 16383
HEAD PHONES MIXING control		B6 B6	1 33	MSB LSB	— —	— —	— —	0-16383 When turned fully counterclockwise: 0 / When turned fully clockwise: 16383
HEAD PHONES LEVEL control		B6 B6	2 34	MSB LSB	— —	— —	— —	0-16383 When turned fully counterclockwise: 0 / When turned fully clockwise: 16383
EQ [HI] control	Deck A	B6 B6	7 39	MSB LSB	— —	— —	— —	0-16383 When turned fully counterclockwise: 0 / When turned fully clockwise: 16383
	Deck B	B6 B6	8 40	MSB LSB	— —	— —	— —	0-16383 When turned fully counterclockwise: 0 / When turned fully clockwise: 16383
	Deck C	B6 B6	9 41	MSB LSB	— —	— —	— —	0-16383 When turned fully counterclockwise: 0 / When turned fully clockwise: 16383
	Deck D	B6 B6	10 42	MSB LSB	— —	— —	— —	0-16383 When turned fully counterclockwise: 0 / When turned fully clockwise: 16383
EQ [MID] control	Deck A	B6 B6	11 43	MSB LSB	— —	— —	— —	0-16383 When turned fully counterclockwise: 0 / When turned fully clockwise: 16383
	Deck B	B6 B6	12 44	MSB LSB	— —	— —	— —	0-16383 When turned fully counterclockwise: 0 / When turned fully clockwise: 16383
	Deck C	B6 B6	13 45	MSB LSB	— —	— —	— —	0-16383 When turned fully counterclockwise: 0 / When turned fully clockwise: 16383
	Deck D	B6 B6	14 46	MSB LSB	— —	— —	— —	0-16383 When turned fully counterclockwise: 0 / When turned fully clockwise: 16383
EQ [LOW] control	Deck A	B6 B6	15 47	MSB LSB	— —	— —	— —	0-16383 When turned fully counterclockwise: 0 / When turned fully clockwise: 16383
	Deck B	B6 B6	16 48	MSB LSB	— —	— —	— —	0-16383 When turned fully counterclockwise: 0 / When turned fully clockwise: 16383
	Deck C	B6 B6	17 49	MSB LSB	— —	— —	— —	0-16383 When turned fully counterclockwise: 0 / When turned fully clockwise: 16383
	Deck D	B6 B6	18 50	MSB LSB	— —	— —	— —	0-16383 When turned fully counterclockwise: 0 / When turned fully clockwise: 16383

SW Name		MIDI message (this unit to computer)						Remarks (dd values)
		When SHIFT button is off			When SHIFT button is on			
COLOR control	Deck A	B6 B6	27 59	MSB LSB	— —	— —	— —	0-16383 When turned fully counterclockwise: 0 / When turned fully clockwise: 16383
	Deck B	B6 B6	28 60	MSB LSB	— —	— —	— —	0-16383 When turned fully counterclockwise: 0 / When turned fully clockwise: 16383
	Deck C	B6 B6	29 61	MSB LSB	— —	— —	— —	0-16383 When turned fully counterclockwise: 0 / When turned fully clockwise: 16383
	Deck D	B6 B6	30 62	MSB LSB	— —	— —	— —	0-16383 When turned fully counterclockwise: 0 / When turned fully clockwise: 16383
HEADPHONES CUE button	Deck A	96	84	dd	96	96	dd	OFF=0, ON=127
	Deck B	96	85	dd	96	97	dd	OFF=0, ON=127
	Deck C	96	86	dd	96	98	dd	OFF=0, ON=127
	Deck D	96	87	dd	96	99	dd	OFF=0, ON=127
Channel fader	Deck A	B6 B6	19 51	MSB LSB	— —	— —	— —	0-16383 Lower edge: 0 / Upper edge: 16383
	Deck B	B6 B6	21 53	MSB LSB	— —	— —	— —	0-16383 Lower edge: 0 / Upper edge: 16383
	Deck C	B6 B6	23 55	MSB LSB	— —	— —	— —	0-16383 Lower edge: 0 / Upper edge: 16383
	Deck D	B6 B6	25 57	MSB LSB	— —	— —	— —	0-16383 Lower edge: 0 / Upper edge: 16383
Crossfader		B6 B6	31 63	MSB LSB	— —	— —	— —	0-16383 Left edge: 0 / Right edge: 16383
Crossfader curve selector switch	THRU	96	65	dd	—	—	—	OFF=0, ON=127
		96	66	dd	—	—	—	OFF=0, ON=127
		96	67	dd	—	—	—	OFF=0, ON=127
MIC (ON/OFF) button		96	70	dd	96	102	dd	OFF=0, ON=127
AUX (ON/OFF) button		96	75	dd	96	103	dd	OFF=0, ON=127
DECK, PHONO/LINE selector switch	DECK 1	96	79	dd	—	—	—	OFF=0, ON=127
	PHONO1/LINE1	96	80	dd	—	—	—	OFF=0, ON=127
	DECK 2	96	81	dd	—	—	—	OFF=0, ON=127
	PHONO2/LINE2	96	82	dd	—	—	—	OFF=0, ON=127

Names of switches and indicators		MIDI message (computer to this unit)						Remarks (dd values)
		When SHIFT button is off			When SHIFT button is on			
MASTER LEVEL control		B6	0	dd	—	—	—	0-127 When turned fully counterclockwise: 0 / When turned fully clockwise: 127
AUX LEVEL control		B6	24	dd	—	—	—	0-127 When turned fully counterclockwise: 0 / When turned fully clockwise: 127
BOOTH MONITOR control		B6	26	dd	—	—	—	0-127 When turned fully counterclockwise: 0 / When turned fully clockwise: 127
MIC LEVEL control		B6	20	dd	—	—	—	0-127 When turned fully counterclockwise: 0 / When turned fully clockwise: 127
MIC EQ control		B6	22	dd	—	—	—	0-127 When turned fully counterclockwise: 0 / When turned fully clockwise: 127
TRIM control	Deck A	B6	3	dd	—	—	—	0-127 When turned fully counterclockwise: 0 / When turned fully clockwise: 127
	Deck B	B6	4	dd	—	—	—	0-127 When turned fully counterclockwise: 0 / When turned fully clockwise: 127
	Deck C	B6	5	dd	—	—	—	0-127 When turned fully counterclockwise: 0 / When turned fully clockwise: 127
	Deck D	B6	6	dd	—	—	—	0-127 When turned fully counterclockwise: 0 / When turned fully clockwise: 127

Names of switches and indicators		MIDI message (computer to this unit)						Remarks (dd values)
		When SHIFT button is off			When SHIFT button is on			
EQ [HI] control	Deck A	B6	7	dd	—	—	—	0-127 When turned fully counterclockwise: 0 / When turned fully clockwise: 127
	Deck B	B6	8	dd	—	—	—	0-127 When turned fully counterclockwise: 0 / When turned fully clockwise: 127
	Deck C	B6	9	dd	—	—	—	0-127 When turned fully counterclockwise: 0 / When turned fully clockwise: 127
	Deck D	B6	10	dd	—	—	—	0-127 When turned fully counterclockwise: 0 / When turned fully clockwise: 127
EQ [MID] control	Deck A	B6	11	dd	—	—	—	0-127 When turned fully counterclockwise: 0 / When turned fully clockwise: 127
	Deck B	B6	12	dd	—	—	—	0-127 When turned fully counterclockwise: 0 / When turned fully clockwise: 127
	Deck C	B6	13	dd	—	—	—	0-127 When turned fully counterclockwise: 0 / When turned fully clockwise: 127
	Deck D	B6	14	dd	—	—	—	0-127 When turned fully counterclockwise: 0 / When turned fully clockwise: 127
EQ [LOW] control	Deck A	B6	15	dd	—	—	—	0-127 When turned fully counterclockwise: 0 / When turned fully clockwise: 127
	Deck B	B6	16	dd	—	—	—	0-127 When turned fully counterclockwise: 0 / When turned fully clockwise: 127
	Deck C	B6	17	dd	—	—	—	0-127 When turned fully counterclockwise: 0 / When turned fully clockwise: 127
	Deck D	B6	18	dd	—	—	—	0-127 When turned fully counterclockwise: 0 / When turned fully clockwise: 127
COLOR control	Deck A	B6	27	dd	—	—	—	0-127 When turned fully counterclockwise: 0 / When turned fully clockwise: 127
	Deck B	B6	28	dd	—	—	—	0-127 When turned fully counterclockwise: 0 / When turned fully clockwise: 127
	Deck C	B6	29	dd	—	—	—	0-127 When turned fully counterclockwise: 0 / When turned fully clockwise: 127
	Deck D	B6	30	dd	—	—	—	0-127 When turned fully counterclockwise: 0 / When turned fully clockwise: 127
HEADPHONES CUE button	Deck A	96	84	dd	96	96	dd	Off = 0, lit = 127
	Deck B	96	85	dd	96	97	dd	Off = 0, lit = 127
	Deck C	96	86	dd	96	98	dd	Off = 0, lit = 127
	Deck D	96	87	dd	96	99	dd	Off = 0, lit = 127
HEAD PHONES MIXING control		B6	1	dd	—	—	—	0-127 When turned fully counterclockwise: 0 / When turned fully clockwise: 127
HEAD PHONES LEVEL control		B6	2	dd	—	—	—	0-127 When turned fully counterclockwise: 0 / When turned fully clockwise: 127
Channel fader	Deck A	B6	19	dd	—	—	—	0-127 Lower edge: 0 / Upper edge: 127
	Deck B	B6	21	dd	—	—	—	0-127 Lower edge: 0 / Upper edge: 127
	Deck C	B6	23	dd	—	—	—	0-127 Lower edge: 0 / Upper edge: 127
	Deck D	B6	25	dd	—	—	—	0-127 Lower edge: 0 / Upper edge: 127
Crossfader		B6	31	dd	—	—	—	0-127 Left edge: 0 / Right edge: 127
MIC (ON/OFF) button		96	70	dd	96	102	dd	Off = 0, lit = 127
AUX (ON/OFF) button		96	75	dd	96	103	dd	Off = 0, lit = 127

Names of switches and indicators		MIDI message (computer to this unit)						Remarks (dd values)
		When SHIFT button is off			When SHIFT button is on			
Channel level meter	Deck A	B6	71	dd	—	—	—	0-127
	Deck B	B6	72	dd	—	—	—	0-127
	Deck C	B6	73	dd	—	—	—	0-127
	Deck D	B6	74	dd	—	—	—	0-127

3 Effects

SW Name		MIDI message (this unit to computer)						Remarks (dd values)
		When SHIFT button is off			When SHIFT button is on			
BEAT control	Deck A	B4	0	dd	B4	16	dd	0-127 When turned fully counterclockwise: 0 / When turned fully clockwise: 127
	Deck B	B5	0	dd	B5	16	dd	0-127 When turned fully counterclockwise: 0 / When turned fully clockwise: 127
	Deck C	B4	8	dd	B4	24	dd	0-127 When turned fully counterclockwise: 0 / When turned fully clockwise: 127
	Deck D	B5	8	dd	B5	24	dd	0-127 When turned fully counterclockwise: 0 / When turned fully clockwise: 127
FX SELECT button (TRANS)	Deck A	94	70	dd	94	98	dd	OFF=0, ON=127
	Deck B	95	70	dd	95	98	dd	OFF=0, ON=127
	Deck C	94	74	dd	94	102	dd	OFF=0, ON=127
	Deck D	95	74	dd	95	102	dd	OFF=0, ON=127
FX SELECT button (FLANGER)	Deck A	94	71	dd	94	99	dd	OFF=0, ON=127
	Deck B	95	71	dd	95	99	dd	OFF=0, ON=127
	Deck C	94	75	dd	94	103	dd	OFF=0, ON=127
	Deck D	95	75	dd	95	103	dd	OFF=0, ON=127
FX SELECT button (ECHO)	Deck A	94	72	dd	94	100	dd	OFF=0, ON=127
	Deck B	95	72	dd	95	100	dd	OFF=0, ON=127
	Deck C	94	76	dd	94	104	dd	OFF=0, ON=127
	Deck D	95	76	dd	95	104	dd	OFF=0, ON=127
FX SELECT button (ROLL)	Deck A	94	73	dd	94	101	dd	OFF=0, ON=127
	Deck B	95	73	dd	95	101	dd	OFF=0, ON=127
	Deck C	94	77	dd	94	105	dd	OFF=0, ON=127
	Deck D	95	77	dd	95	105	dd	OFF=0, ON=127
LEVEL/DEPTH control	Deck A	B4 B4	2 34	MSB LSB	B4 B4	18 50	MSB LSB	0-16383 When turned fully counterclockwise: 0 / When turned fully clockwise: 16383
	Deck B	B5 B5	2 34	MSB LSB	B5 B5	18 50	MSB LSB	0-16383 When turned fully counterclockwise: 0 / When turned fully clockwise: 16383
	Deck C	B4 B4	10 42	MSB LSB	B4 B4	26 58	MSB LSB	0-16383 When turned fully counterclockwise: 0 / When turned fully clockwise: 16383
	Deck D	B5 B5	10 42	MSB LSB	B5 B5	26 58	MSB LSB	0-16383 When turned fully counterclockwise: 0 / When turned fully clockwise: 16383
TAP button	Deck A	94	88	dd	94	116	dd	OFF=0, ON=127
	Deck B	95	88	dd	95	116	dd	OFF=0, ON=127
	Deck C	94	89	dd	94	117	dd	OFF=0, ON=127
	Deck D	95	89	dd	95	117	dd	OFF=0, ON=127
SOUND COLOR FX buttons	FILTER	94	78	dd	94	106	dd	OFF=0, ON=127
	PITCH	94	79	dd	94	107	dd	OFF=0, ON=127
	CRASH	94	80	dd	94	108	dd	OFF=0, ON=127
	NOISE	94	81	dd	94	109	dd	OFF=0, ON=127

Names of switches and indicators		MIDI message (computer to this unit)						Remarks (dd values)
		When SHIFT button is off			When SHIFT button is on			
BEAT control	Deck A	B4	0	dd	B4	16	dd	0-127 When turned fully counterclockwise: 0 / When turned fully clockwise: 127
	Deck B	B5	0	dd	B5	16	dd	0-127 When turned fully counterclockwise: 0 / When turned fully clockwise: 127
	Deck C	B4	8	dd	B4	24	dd	0-127 When turned fully counterclockwise: 0 / When turned fully clockwise: 127
	Deck D	B5	8	dd	B5	24	dd	0-127 When turned fully counterclockwise: 0 / When turned fully clockwise: 127
FX SELECT button (TRANS)	Deck A	94	70	dd	94	98	dd	Off = 0, lit = 127
	Deck B	95	70	dd	95	98	dd	Off = 0, lit = 127
	Deck C	94	74	dd	94	102	dd	Off = 0, lit = 127
	Deck D	95	74	dd	95	102	dd	Off = 0, lit = 127
FX SELECT button (FLANGER)	Deck A	94	71	dd	94	99	dd	Off = 0, lit = 127
	Deck B	95	71	dd	95	99	dd	Off = 0, lit = 127
	Deck C	94	75	dd	94	103	dd	Off = 0, lit = 127
	Deck D	95	75	dd	95	103	dd	Off = 0, lit = 127
FX SELECT button (ECHO)	Deck A	94	72	dd	94	100	dd	Off = 0, lit = 127
	Deck B	95	72	dd	95	100	dd	Off = 0, lit = 127
	Deck C	94	76	dd	94	104	dd	Off = 0, lit = 127
	Deck D	95	76	dd	95	104	dd	Off = 0, lit = 127
FX SELECT button (ROLL)	Deck A	94	73	dd	94	101	dd	Off = 0, lit = 127
	Deck B	95	73	dd	95	101	dd	Off = 0, lit = 127
	Deck C	94	77	dd	94	105	dd	Off = 0, lit = 127
	Deck D	95	77	dd	95	105	dd	Off = 0, lit = 127
TAP button	Deck A	94	88	dd	94	116	dd	Off = 0, lit = 127
	Deck B	95	88	dd	95	116	dd	Off = 0, lit = 127
	Deck C	94	89	dd	94	117	dd	Off = 0, lit = 127
	Deck D	95	89	dd	95	117	dd	Off = 0, lit = 127
LEVEL/DEPTH control	Deck A	B4	2	dd	B4	18	dd	0-127 When turned fully counterclockwise: 0 / When turned fully clockwise: 127
	Deck B	B5	2	dd	B5	18	dd	0-127 When turned fully counterclockwise: 0 / When turned fully clockwise: 127
	Deck C	B4	10	dd	B4	26	dd	0-127 When turned fully counterclockwise: 0 / When turned fully clockwise: 127
	Deck D	B5	10	dd	B5	26	dd	0-127 When turned fully counterclockwise: 0 / When turned fully clockwise: 127
SOUND COLOR FX buttons	FILTER	94	78	dd	94	106	dd	Off = 0, lit = 127
	PITCH	94	79	dd	94	107	dd	Off = 0, lit = 127
	CRASH	94	80	dd	94	108	dd	Off = 0, lit = 127
	NOISE	94	81	dd	94	109	dd	Off = 0, lit = 127

4 Others (when remotebox connected)

Names of switches and indicators (remotebox)		MIDI message (this unit to computer)			Remarks (dd values)
Deck switching	Deck C → A	90	90	dd	OFF=0, ON=127
	Deck D → B	91	90	dd	OFF=0, ON=127
	Deck A → C	92	90	dd	OFF=0, ON=127
	Deck B → D	93	90	dd	OFF=0, ON=127
Needle search pad		Bn	105	dd	0-127 0 at left edge, 127 at right edge

Additional information

Troubleshooting

- Incorrect operation is often mistaken for trouble or malfunction. If you think that there is something wrong with this component, check the points below. Sometimes the trouble may lie in another component. Inspect the other components and electrical appliances being used. If the trouble cannot be rectified after checking the items below, ask your nearest Pioneer authorized service center or your dealer to carry out repair work.
- This unit may not operate properly due to static electricity or other external influences. In this case, proper operation may be restored by turning the power off, waiting 1 minute, then turning the power back on.

Power supply

Problem	Check	Remedy
The power is not turned on. None of the indicators light.	Is the power cord properly connected? Is the [STANDBY/ON] button for power supply set to [ON] ?	Plug in the power cord to an AC outlet. (page 10) Set the [STANDBY/ON] button for power supply to [ON] . (page 21)
The [STANDBY/ON] indicator flashes and the power does not turn on.	—	Normal operation can sometimes be restored by unplugging the power cord, waiting at least 1 minute, then plugging the power cord back in. If the symptom persists, unplug the power cord and request repairs.



Audio output

Problem	Check	Remedy
No sound or small sound.	Are the [DECK 1, PHONO1/LINE1] and [DECK 2, PHONO2/LINE2] selector switches set to the proper positions? Are the [TRIM] control, channel faders, crossfader and [MASTER LEVEL] control set to the proper positions?	Switch the channel's input source using the [DECK 1, PHONO1/LINE1] and [DECK 2, PHONO2/LINE2] selector switches. (Page 22) Set the [TRIM] control, channel faders, crossfader and [MASTER LEVEL] control to the proper positions. (Page 22)
	Is the [LINE, PHONO] selector switch on this unit's rear panel properly set?	Properly set the [LINE, PHONO] selector switch on this unit's rear panel according to the connected device. (page 10)
Distorted sound.	Is the [MASTER LEVEL] control set to the proper position? Is the [TRIM] control set to the proper position?	Adjust [MASTER LEVEL] so that the orange indicator on the master level indicator lights at the peak level. (Page 22) Adjust [TRIM] so that the orange indicator on the channel level indicator lights at the peak level. (Page 22)
	Is the [LINE, PHONO] selector switch on this unit's rear panel properly set?	Properly set the [LINE, PHONO] selector switch on this unit's rear panel according to the connected device. (page 10)
	Is the sound level input to the [MIC] terminal set to an appropriate level?	Set the [MIC LEVEL] control to the proper position. (page 19)
	Is the sound level input to the [AUX IN] terminal set to an appropriate level?	Set the [AUX LEVEL] control to the proper position. (page 19)
No sound is produced, or sound is distorted or noisy.	Is this unit placed near a TV?	Turn the TV's power off or install this unit and TV away from each other.
Microphone sound is not output or volume is low.	Is the [MIC LEVEL] control set to the proper position? Is the switch on this unit or the microphone turned off?	Set the [MIC LEVEL] control to the proper position. (page 19) Turn the switch on.
Sound is distorted when an analog player is connected to this unit's [PHONO/LINE] terminals. Or, lighting of the channel level indicator does not change even when the [TRIM] control is turned.	Have you connected an analog player with a built-in phono equalizer? Is an audio interface for computers connected between the analog player and this unit?	For analog players with built-in phono equalizers, use with the [LINE, PHONO] selector switch on this unit's rear panel switched to [LINE] . (page 10) If the analog player with built-in phono equalizer has a PHONO/LINE selector switch, switch it to PHONO. If the output of the audio interface for computers is line level, use with the [LINE, PHONO] selector switch on this unit's rear panel switched to [LINE] . (page 10) If the analog player has a PHONO/LINE selector switch, switch it to PHONO.

Display

Problem	Check	Remedy
The playing address display is not displayed in the remaining time mode.	—	When playing files recorded in VBR, it may happen that the set cannot detect the length of the track immediately and that some time is required for the playing address display to appear.
The category is not displayed.	Is the rekordbox library information stored on the USB device? Is the USB device write-protected?	Use a device onto which the library information has been exported from rekordbox. Cancel the USB device's write-protection so that this unit can write on it.
Nothing is displayed.	Is the auto standby function activated?	This unit is shipped with the auto standby function turned on. If you do not want to use the auto standby function, set [AUTO STANDBY] to [OFF] . (page 24)

Functions and operations

Problem	Check	Remedy
Can't crossfade.	Is the [CROSS F. CURVE (THRU, )] (cross-fader curve selector) switch set to [THRU] ?	Set the [CROSS F. CURVE (THRU, )] (crossfader curve selector) switch to a position other than [THRU] . (Page 22)
Back cue function does not work.	Is a cue point set?	Set a cue point. (page 15)
Beat effect does not work.	Is one of the [BEAT FX] buttons (TRANS, FLANGER, ECHO or ROLL) pressed?	Press one of the [BEAT FX] buttons (TRANS, FLANGER, ECHO or ROLL). (page 20)
	Is the [LEVEL/DEPTH] control set to the center position?	Turn the [LEVEL/DEPTH] control clockwise or counterclockwise. (page 20)
	Is the [BEAT] control set to the proper position?	Set the [BEAT] control to the proper position. (page 20)
Color effect does not work.	Is a [SOUND COLOR FX (NOISE, PITCH, CRUSH, FILTER)] button pressed?	Press one of the [SOUND COLOR FX (NOISE, PITCH, CRUSH, FILTER)] buttons. (page 20)
	Is the [COLOR] control set to the proper position?	Set the [COLOR] control to the proper position. (page 20)
[SYNC] function does not work.	Has the music file been analyzed?	Analyze the file. (page 23)
[SYNC] function does not work even when files are analyzed.	Is the beat grid irregular? Is the beat grid properly tapped?	Set the beat grid properly. (page 23)
	Are the BPMs of the tracks in the two decks too different?	The [SYNC] function will not work properly if the BPM of the track on the deck for which the [SYNC] button is pressed is outside the adjustable tempo range of the track on the deck for which the [SYNC] button is not pressed.
	Are you scratching?	The [SYNC] function is disabled when scratching.
Settings are not stored in the memory.	Has the power been turned off directly after changing the setting?	After changing settings, wait at least 10 seconds before turning the power off. After editing (recording or deleting) a sampled sound source, be sure to press the [STANDBY/ON] button to turn the power off.

USB devices

Problem	Check	Remedy
USB device is not recognized.	Is the USB device properly connected?	Connect the device securely (all the way in).
	Is the USB device connected via a USB hub?	USB hubs cannot be used.
	Is the USB device supported by this unit?	This unit supports such USB mass storage class USB devices as external hard disks and portable flash memory devices.
	Is the file format supported by this unit?	Check the file format of the connected USB device. For the file formats supported by this unit, see <i>About USB devices</i> on page 5.
	Are you using a USB device (such as a bus power-driven hard disk) whose current is higher than this unit's rated current (500 mA)?	Use a USB device within this unit's rated current (such as a hard disk driven by an AC adapter or other external power supply).
—	—	Turn the power off, wait 1 minute, then turn the power back on.
Time is required to read USB devices (flash memory drives and hard discs).	Is there a large number of folders or files recorded on the USB device?	When there are many folders or files, some time may be required for loading.
	Are files other than music files stored on the USB device?	When files other than music files are stored in folders, time is required to read them as well. Do not store files or folders other than music files on the USB device.
Playback does not start when a track is loaded from a USB device.	Are the files playable?	See <i>Playable music file formats</i> on page 5.
	Is the auto cue function activated?	Press the [TIME(AUTO CUE, QUANTIZE)] button for over 1 second to cancel the auto cue function. (page 18)
File cannot be played.	Is the file copyright-protected (by DRM)?	Copyright-protected files cannot be played.
Music files cannot be played.	Are the music files damaged?	Play music files that are not damaged.

DJ software

Problem	Check	Remedy
DJ software on a computer cannot be operated.	Is the included USB cable properly connected?	Connect the computer and this unit directly using the included USB cable. USB hubs cannot be used. (page 10)
DJ software's sound is not properly output.	Are the DJ software's output settings and this unit's [MIXER MODE] setting properly set?	Check the DJ software's settings, then check this unit's settings on the [UTILITY] screen and set the proper signal path. (page 27)
	Is the driver software properly set?	Set the driver software properly. (Page 26)
	Are the connection cables properly connected?	Connect the connection cables properly. (page 10)
	Are terminals or plugs dirty?	Wipe any dirt off terminals and plugs before connecting.
	Is the connected, power amplifier, powered speakers, etc., properly set?	Properly set the external input selection, volume, etc., on the power amplifier, powered speakers, etc.
Sound being played is interrupted when using DJ software.	Is the driver software's latency value suitable?	Set the driver software's latency to a suitable value. (Page 26)
	—	Set the DJ software's latency to a suitable value.

Wireless LAN

Problem	Check	Remedy
Links cannot be established.	Is the wireless LAN connection properly connected?	Properly connect the mobile device and this unit by wireless LAN. (page 11) See "Basic Operation" in the remotebox operating instructions.
	Is another mobile device already connected?	Only one mobile device can be connected.
Connection with mobile device is not possible, mobile device cannot be operated or no sound is produced.	Is there a device producing electromagnetic waves in the 2.4 GHz band (microwave oven, other wireless LAN device, etc.) nearby?	Either install this unit away from the device producing electromagnetic waves or stop using the device producing electromagnetic waves.
	Are the mobile device and this unit too far apart or is there an obstacle between them?	Install in the same room within a line-of-sight distance (with no obstacles) of 40 meters. (This line-of-sight distance is rough indication. The actual distance at which communications are possible may differ, depending on the surrounding environment.)

Error messages







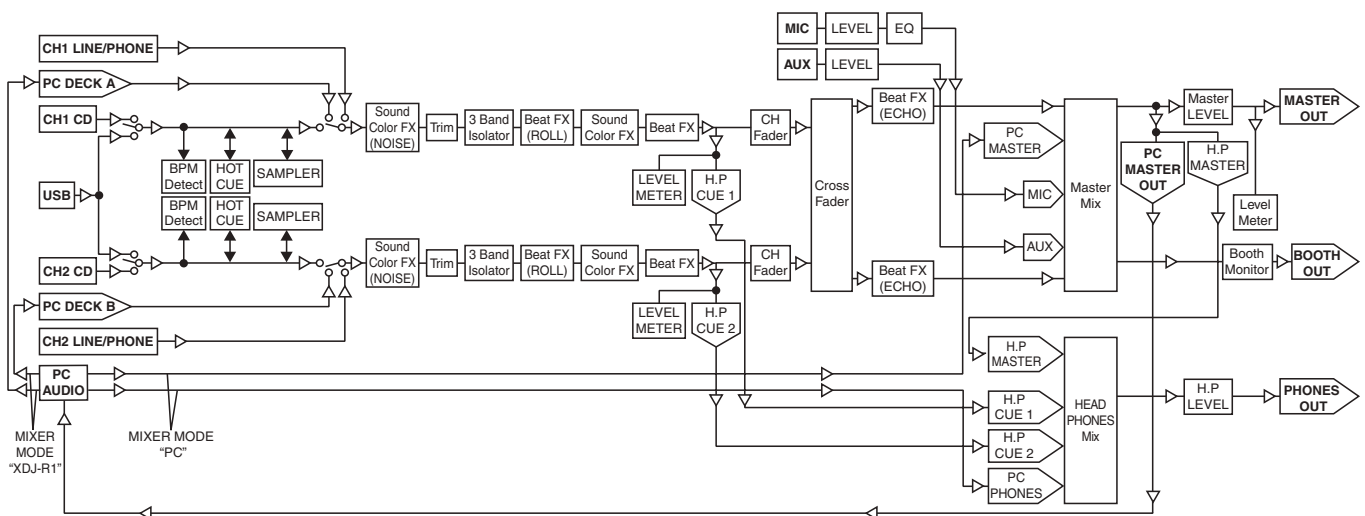

When this unit cannot operate normally, an error code appears on the display. Check the table below and take the measures indicated. If an error code not shown on the table below is displayed, or if the same error code is displayed again after taking the indicated action, contact your store of purchase or a nearby Pioneer service station.

Error code	Error type	Description of error	Cause and action
E-7201	CANNOT READ DISC	TOC data cannot be read.	<ul style="list-style-type: none"> Disc is cracked. → Replace the disc.
E-8301	CANNOT READ DISC	Disc that cannot be played normally is loaded.	<ul style="list-style-type: none"> Disc is dirty. → Clean the disc.
E-8302	CANNOT PLAY TRACK	Track data (file) on the disc or storage device (USB) cannot be read properly.	<ul style="list-style-type: none"> If operation is normal with other discs, the problem is with that disc.
E-8303	CANNOT PLAY TRACK		<ul style="list-style-type: none"> The track data (file) may be corrupt. → Check whether the track (file) can be played on another player, etc., capable of playing the same formats as this unit.
E-8304 E-8305	UNSUPPORTED FILE FORMAT	Music files that cannot be played normally are loaded.	Format is wrong. → Replace with music files in the proper format.
E-9101	MECHANICAL TIMEOUT	Mechanical error (time out) during loading or ejecting of disc.	Displayed when mechanism operation is not completed within the specified time.

Block Diagram



List of icons displayed on the main unit display section

	Track/file name		Folder
	Artist		Playing
	Album		Playback is not possible
	Playlist		Track for which hot cue auto loading is set

Cautions on use

About condensation

Water droplets (condensation) may form inside the unit (on operating parts and lenses) in the winter, for example, if the unit is moved from a cold place into a warm room or if the temperature in the room in which the unit is installed rises suddenly (through heating, etc.). The unit will not operate properly and will not be playable with condensation inside. Let the unit stand for 1 to 2 hours at room temperature (though this time depends on the conditions of the condensation) without turning on the power. The water droplets will evaporate and the unit will become playable. Condensation can occur in the summer as well if the unit is exposed to the direct wind from an air-conditioner, etc. If this happens, move the unit to a different location.

Cleaning the lens

The player's lens should not become dirty in normal use, but if for some reason it should malfunction due to dust or dirt, consult your nearest Pioneer authorized service center. Although lens cleaners for players are commercially available, we advise against using them since some may damage the lens.

Handling discs

Storing

- Always place discs in their cases and store them vertically, avoiding hot, humid places, places exposed to direct sunlight and extremely cold places.
- Be sure to read the cautions included with the disc.

Cleaning discs

- Discs may not play if there are fingerprints or dust on them. In this case, use a cleaning cloth, etc., to gently wipe the disc from the inside towards the outside. Do not use dirty cleaning cloths.



- Do not use benzene, thinner or other volatile chemicals. Also do not use record spray or antistatic agents.
- For tough dirt, apply some water to a soft cloth, wring out thoroughly, wipe off the dirt, then wipe off the moisture with a dry cloth.
- Do not use damaged (cracked or warped) discs.
- Do not let the signal surface of discs get scratched or dirty.
- Do not place two discs in the disc tray, one on top of the other.

- Do not attach pieces of paper or stickers to discs. Doing so could warp discs, making it impossible to play them. Also note that rental discs often have labels attached to them, and the label's glue may have oozed out. Check that there is no glue around the edges of such labels before using rented discs.

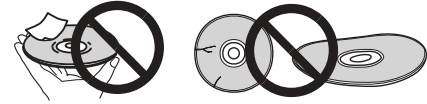

About specially shaped discs

Irregularly shaped discs other than standard 12 cm discs cannot be played on this unit (doing so will lead to damage or accidents). Specially shaped discs (heart-shaped, hexagonal, etc.) cannot be played on this unit. Do not attempt to play such discs, as they could damage the unit.



About condensation on discs

Water droplets (condensation) may form on the surface of discs if they are moved from a cold place (particularly in winter) into a warm room. Discs may not play normally if there is condensation on them. Carefully wipe the water droplets off the surface of the disc before loading it.

About trademarks and registered trademarks

- Pioneer, rekordbox and remotebox are trademarks or registered trademarks of the PIONEER CORPORATION.
- Microsoft, Windows, Windows Vista and Internet Explorer are either registered trademarks or trademarks of Microsoft Corporation in the United States and/or other countries.
- Apple, Macintosh, Mac OS, Safari, iTunes, and Finder are trademarks of Apple Inc., registered in the U.S. and other countries.
- Intel and Pentium are trademarks of Intel Corporation in the U.S. and/or other countries.
- ASIO is a trademark of Steinberg Media Technologies GmbH.
- VirtualDJ is a registered trademark of Atomix Productions.

The names of companies and products mentioned herein are the trademarks of their respective owners.

This product has been licensed for nonprofit use. This product has not been licensed for commercial purposes (for profit-making use), such as broadcasting (terrestrial, satellite, cable or other types of broadcasting), streaming on the Internet, Intranet (a corporate network) or other types of networks or distributing of electronic information (online digital music distribution service). You need to acquire the corresponding licenses for such uses. For details, see <http://www.mp3licensing.com>.

— The specifications and design of this product are subject to change without notice.

© 2013 PIONEER CORPORATION.

All rights reserved.

PIONEER CORPORATION

1-1, Shin-ogura, Saiwai-ku, Kawasaki-shi, Kanagawa 212-0031, Japan
<DRI1083-A>