



e 904

Instruction manual



Delivery includes

- e 904
- MZH 604 microphone clamp
- pouch
- quick guide
- safety guide

Product overview

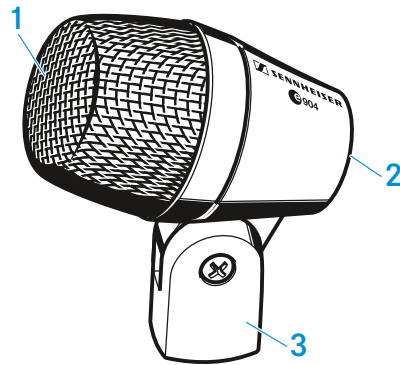

1. Sound inlet basket
2. XLR-3 connector
3. Microphone clamp



Installation

Attaching the microphone

- ▷ Fasten the holder to the microphone using the screw.

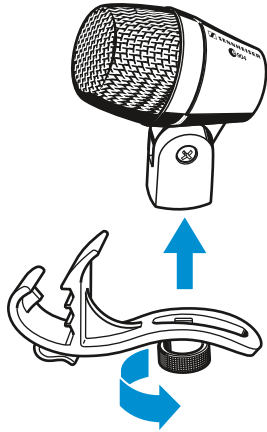

Connecting the microphone

- ▷ Connect the XLR-3 socket of the microphone cable (optional accessories) to the XLR-3 socket of the microphone.

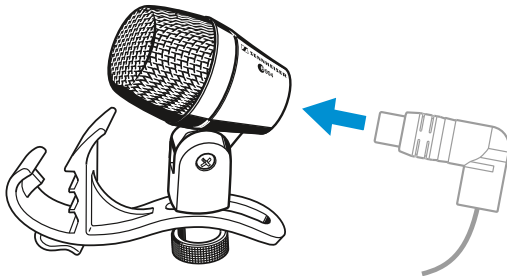



Operation

Positioning the microphone on a drum

- ▷ Use the microphone clamp to attach the e 904 to the rim of the drum.
- ▷ Position the microphone on the drum so that it is 3 to 5cm above the drumhead.

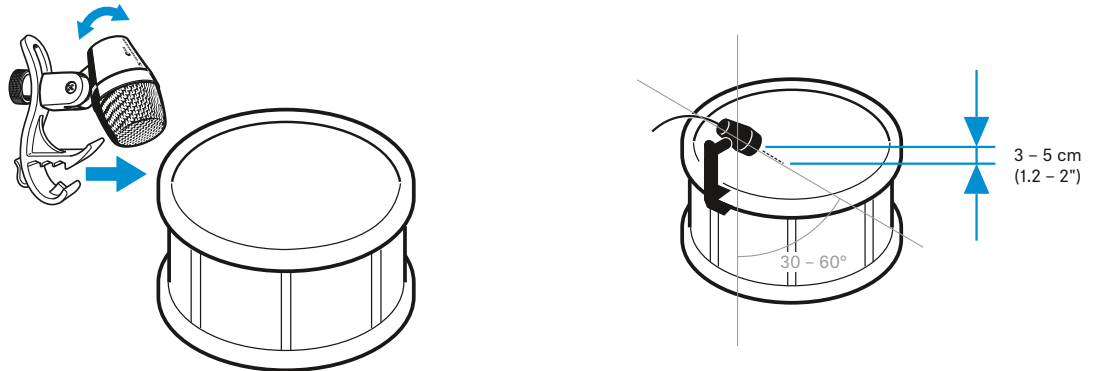

▷ It is vital to observe the following notes:

Position	Resulting sound	Commentary
A	More fundamental Little overtones	Position on the drum: 3 to 5 cm above the drumskin
B	Less fundamental Many overtones	The fundamental to overtones ratio can be adjusted by changing the angle of the microphone. The most balanced results are obtained at an angle of 30 to 60°.
C		Use of a second e 904 for picking up the bottom of the drumskin and the snares. NB: The lower microphone must be phase-reversed to avoid phase-cancellation effects due to the second microphone being on the other side of the drumskin.

A

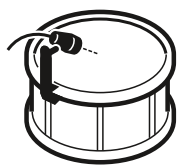

B

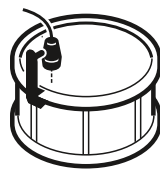

C

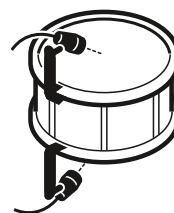



Positioning the monitor loudspeakers

- ▷ To prevent feedback and crosstalk, position your monitor loudspeakers in the angle area of the highest cancellation of the microphone (approx. 180°).

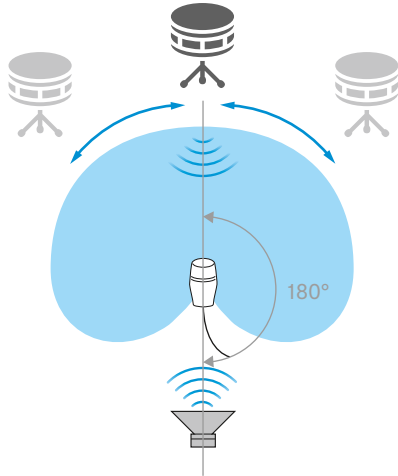

Cleaning and maintaining the e 904

CAUTION

LIQUIDS CAN DAMAGE THE ELECTRONICS OF THE PRODUCT!

Liquids entering the housing of the product can cause a short-circuit and damage the electronics.

- ▷ Keep all liquids away from the product.
 - ▷ Do not use any solvents or cleansing agents.
-
- ▷ Disconnect the products from the power supply system and remove rechargeable batteries and batteries before you begin cleaning.
 - ▷ Clean all products only with a soft, dry cloth.

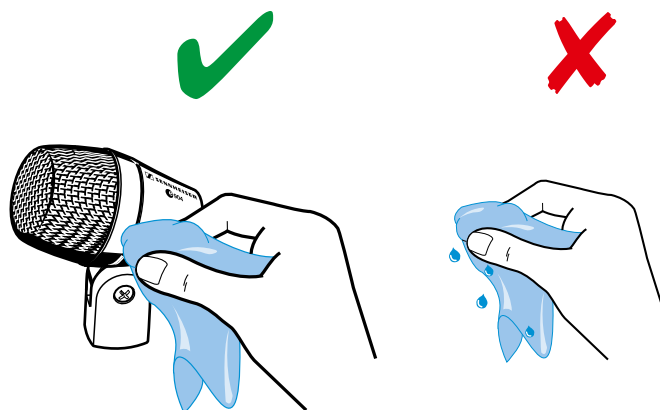



Specifications

Transducer principle	dynamic
Frequency response	40 - 18,000 Hz
Pick-up pattern	cardioid
Sensitivity (free field, no load)	2.0 mV/Pa
Nominal impedance (at 1 kHz)	350 Ω
Min. terminating impedance	1 k Ω
Connector	XLR-3
Dimensions	\varnothing 41 mm, length 63 mm
Weight	125 g

Polar pattern

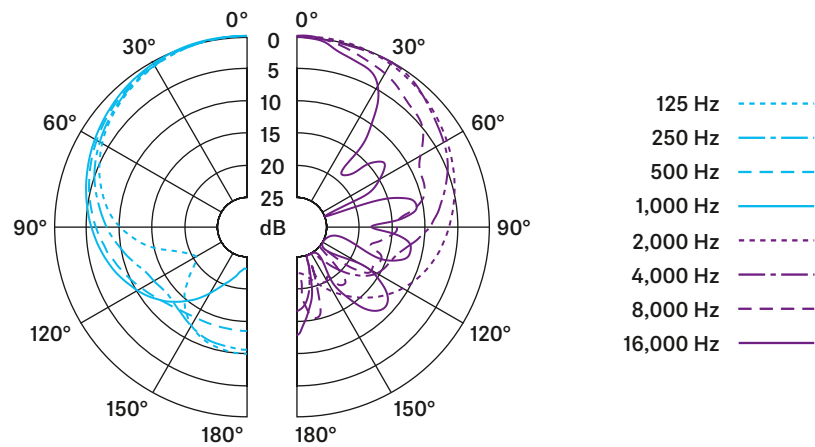

Frequency response

