



evolution wireless G4 ew 300 handheld system

Instruction Manual

Sennheiser electronic GmbH & Co. KG

SENNHEISER

Am Labor 1, 30900 Wedemark, Germany, www.sennheiser.com
ew 300-500 G4 - v1.1



EM 300-500 G4 rack receiver



You can find more detailed information about the EM 300-500 G4 in the following sections:

- Installation and Startup: “Installing the EM 300-500 G4”
- Operation: “Using the EM 300-500 G4”
- Technical Data: “EM 300-500 G4”



SKM 300 G4 handheld transmitter



You can find more detailed information about the SKM 300 G4 in the following sections:

- Installation and Startup: “Installing the SKM 300 G4”
- Operation: “Using the SKM 300 G4”
- Technical Data: “SKM 300 G4”



Accessories

A variety of accessories are available for the ew 300-500 G4 series.

Microphones and cables

Microphone modules

We recommend using the following microphone modules with the SKM 300 G4 and SKM 500 G4 handheld transmitters.

Module	Features	Article no.
MMD 835-1 BK	Dynamic, cardioid, black	502575
MMD 845-1 BK	Dynamic, super-cardioid, black	502576
MME 865-1 BK	Capacitor, super-cardioid, black	502581
MMD 935-1 BK	Dynamic, cardioid, black	502577
MMD 945-1 BK	Dynamic, super-cardioid, black	502579
MMK 965-1 BK	Capacitor, switchable Cardioid/super-cardioid, black	502582
MMK 965-1 NI	Capacitor, switchable Cardioid/super-cardioid, nickel	502584
MD 9235 BK	Dynamic, cardioid, black	502585
MD 9235 NI	Dynamic, cardioid, black	502586
MD 9235 NI/BK	Dynamic, cardioid, nickel/black	502591
Neumann KK 204	Capacitor, cardioid, nickel	008651
Neumann KK 204 BK	Capacitor, cardioid, black	008652
Neumann KK 205	Capacitor, super-cardioid, nickel	008653
Neumann KK 205 BK	Capacitor, super-cardioid, black	008654

i You can find more information about the individual microphone modules on their respective product pages at www.sennheiser.com.



Accessories for rack mounting

GA 3 rack mount kit

19" rack adapter for mounting the EM 100 G4, EM 300 G4, EM 500 G4 or SR 300 IEM G4 in a 19" rack.

Article no. 503167



AM 2 antenna front mounting kit

Antenna front mounting kit for installing antenna connections on the front of the rack when using the EM 100 G4, EM 300 G4, EM 500 G4 or SR 300 IEM G4 together with the GA 3 rack mounting kit.

Article no. 009912





Additional accessories

Color labeling set

- **KEN 2**, color labeling set for SKM handheld transmitters, article no. 530195



Microphone clamp

- **MZQ 1**, microphone clamp for SKM handheld transmitters, article no. 076670





The frequency bank system

There are different frequency ranges in the UHF band available for transmission.

The following frequency ranges are available for the **ew 300-500 G4** series:

- **Aw+ range:** 470 – 558 MHz
- **AS range:** 520 – 558 MHz
- **Gw1 range:** 558 – 608 MHz
- **Gw range:** 558 – 626 MHz
- **GBw range:** 606 – 678 MHz
- **Bw range:** 526 – 698 MHz
- **Cw range:** 718 – 790 MHz
- **Dw range:** 790 – 865 MHz
- **JB range:** 806 – 810 MHz
- **K+ range:** 925 – 937.5 MHz

Every frequency range has **26 frequency banks** with up to 32 channels:

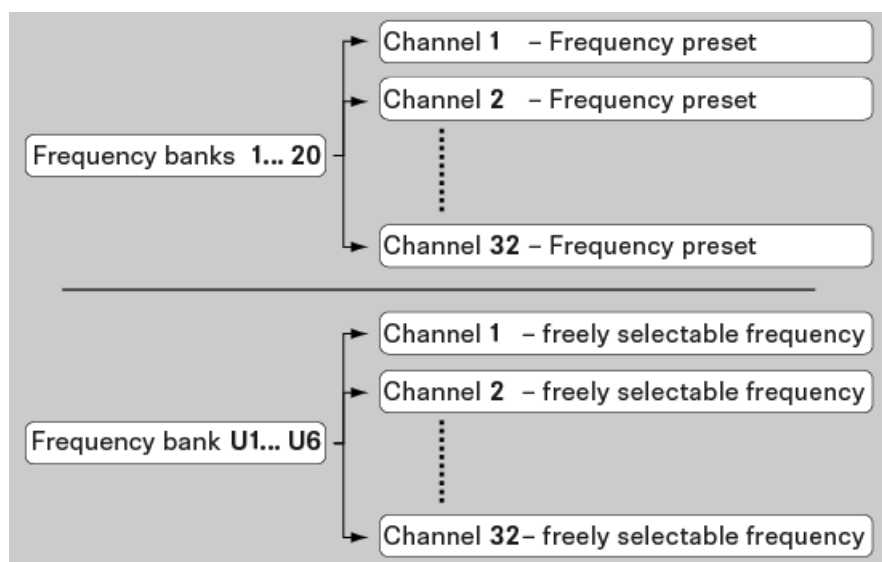

i You can find information about the frequency presets in the frequency tables of the respective frequency ranges under “Frequency tables”.



Installing the EM 300-500 G4

These sections contain detailed information about installing and starting up the EM 300-500 G4.

You can find information about operating the EM 300-500 G4 under “Using the EM 300-500 G4”.

Connectors on the rear of the device

Product overview for the rear of the EM 300-500 G4

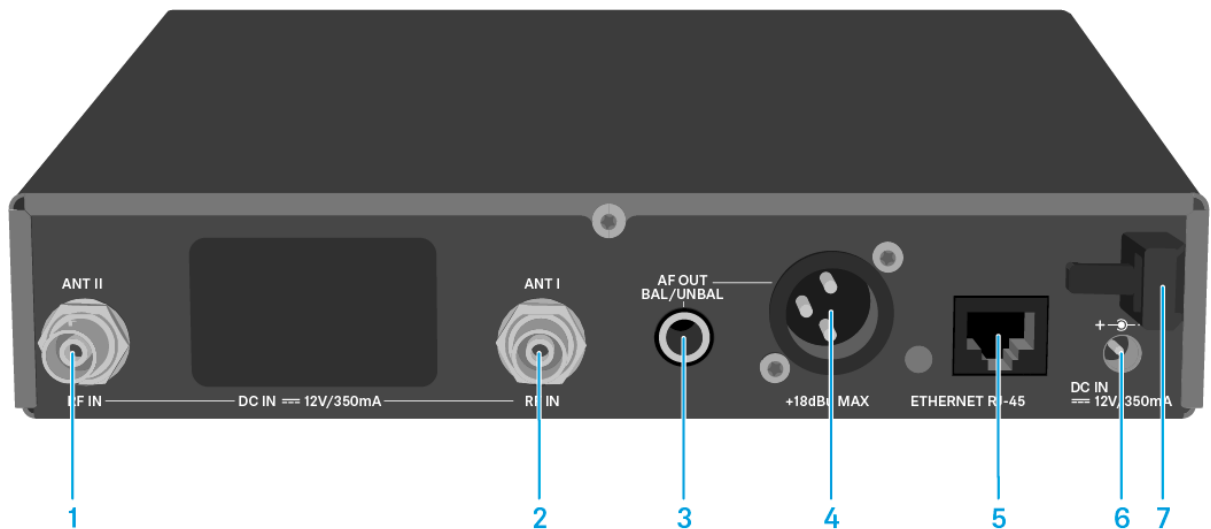

- 1** BNC socket, antenna input II (**ANT II**) with remote power supply unit
 - See “Connecting antennas”
- 2** BNC socket, antenna input I (**ANT I**) with remote power supply unit
 - See “Connecting antennas”
- 3** 6.3 mm jack socket for audio output, unbalanced (**AF OUT UNBAL**)
 - See “Outputting audio signals”
- 4** XLR-3 socket for audio output, balanced (**AF OUT BAL**)
 - See “Outputting audio signals”
- 5** LAN connection socket (**ETHERNET RJ 45**)
 - See “Creating a data network”
- 6** Connecting cables for the power supply unit (**DC IN**)
 - See “Connecting/disconnecting the EM 300-500 G4 to/from the power supply system”
- 7** Strain relief for the cable of the power supply unit
 - See “Connecting/disconnecting the EM 300-500 G4 to/from the power supply system”



Connecting/disconnecting the EM 300-500 G4 to/from the power supply system

Only use the supplied power supply unit. It is designed for your receiver and ensures safe operation.

To connect the EM 300-500 G4 to the power supply system:

- ▷ Insert the plug of the power supply unit into the **DC IN** socket of the receiver.
- ▷ Pass the cable of the power supply unit through the cable grip.
- ▷ Slide the supplied country adapter onto the power supply unit.
- ▷ Plug the power supply unit into the wall socket.

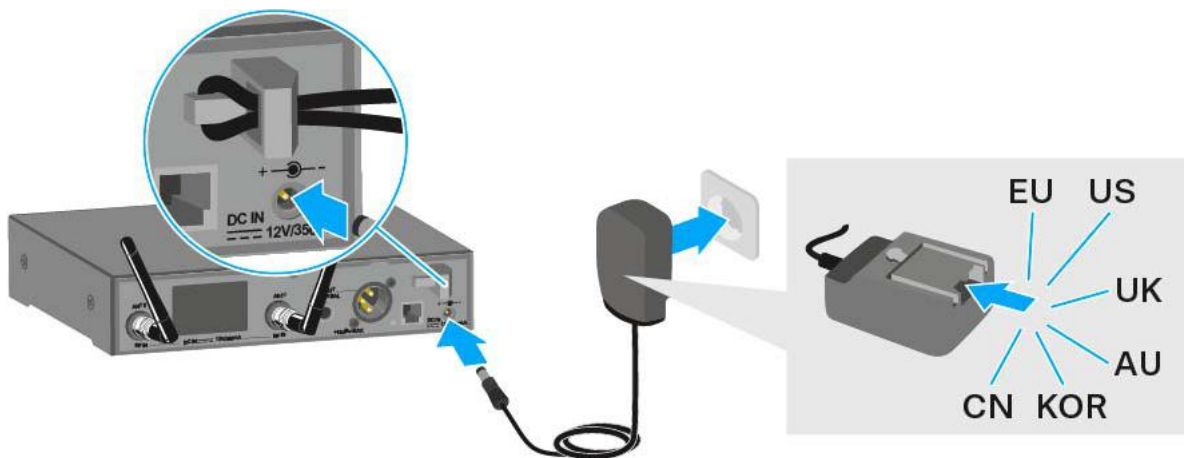

To completely disconnect the EM 300-500 G4 from the power supply system:

- ▷ Unplug the power supply unit from the wall socket.
- ▷ Unplug the power supply unit from the **DC IN** socket of the receiver.



Creating a data network

You can monitor and control one or more EM 300-500 G4s via a network connection using **Sennheiser Wireless Systems Manager (WSM)** software.

i Automatic frequency setup can also be performed over the network without the WSM software. See “Easy Setup menu item”.

To connect the EM 300-500 G4 to a network:

- ▷ Connect a network cable with an RJ-45 connector (to the **Ethernet** socket on the rear side of the EM 300-500 G4).
- ▷ Connect the other end of the network cable to a network switch.

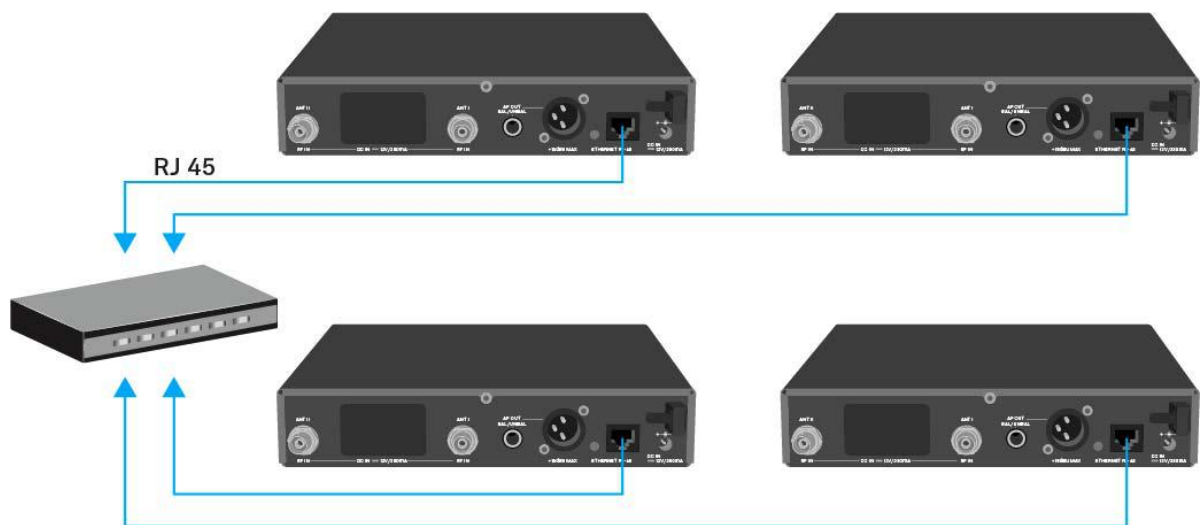

i For more information about controlling devices via the **Sennheiser Wireless Systems Manager (WSM)** software, refer to the instruction manual for the software. You can download the software here:

www.sennheiser.com/wsm



Outputting audio signals

The EM 300-500 G4 has a balanced XLR-3M output socket and an unbalanced 6.3 mm jack output socket.

- Always use only one of the two **BAL AF OUT** output sockets for each channel.

To connect an XLR cable:

- Plug the XLR cable into the **AF OUT BAL** socket of the EM 300-500 G4.

To connect a jack cable:

- Plug the jack cable into the **AF OUT UNBAL** socket of the EM 300-500 G4.

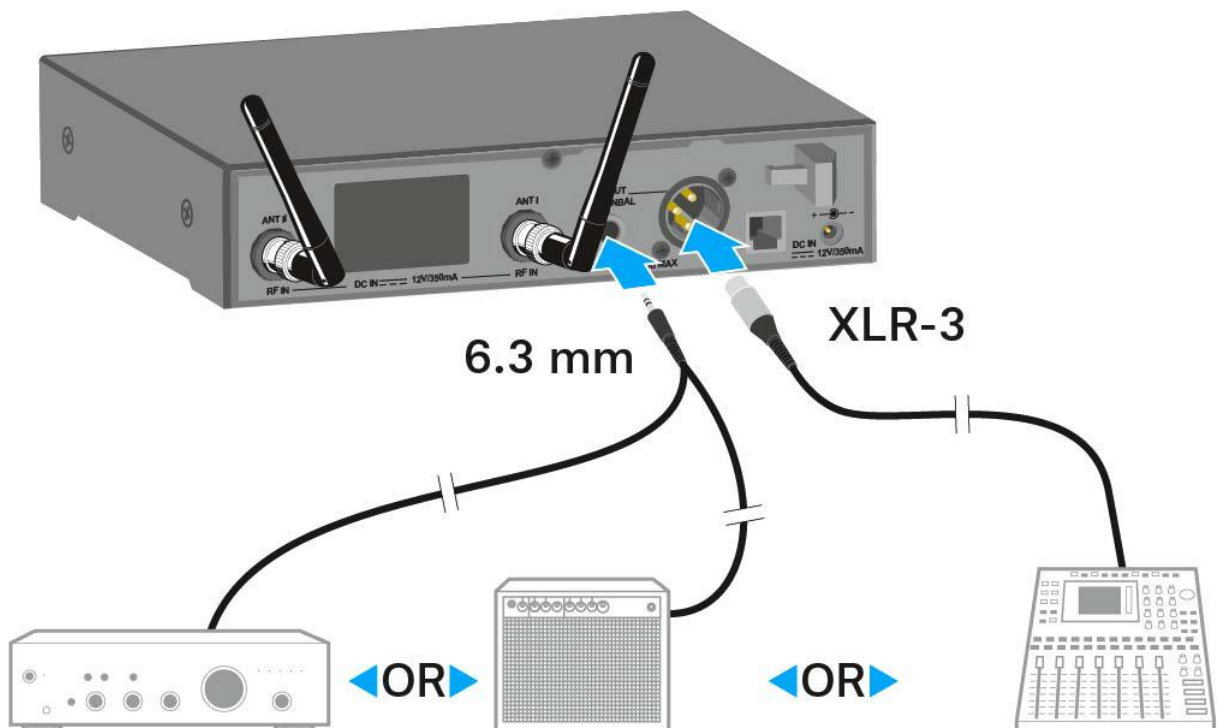



Connecting antennas

To connect the supplied rod antennas:

- ▷ Connect the first rod antenna to the **ANT I** socket on the rear side of the EM 300-500 G4.
- ▷ Connect the second rod antenna to the **ANT II** socket on the rear side of the EM 300-500 G4.
- ▷ Gently angle the rod antennas to the left and right as shown in the figure.



If you are using more than one receiver, we recommend using remote antennas and, as needed, Sennheiser antenna accessories. For more information, visit the ew G4 product page at www.sennheiser.com.



Installing the EM 300-500 G4 in a rack

CAUTION

Rack mounting poses risks

When installing the device in a closed or multi-rack assembly, please consider that, during operation, the ambient temperature, the mechanical loading and the electrical potentials will be different from those of devices which are not mounted into a rack.

- ▷ Make sure that the ambient temperature within the rack does not exceed the permissible temperature limit specified in the specifications. See “Specifications”.
 - ▷ Ensure sufficient ventilation; if necessary, provide additional ventilation.
 - ▷ Make sure that the mechanical loading of the rack is even.
 - ▷ When connecting to the power supply system, observe the information indicated on the type plate. Avoid circuit overloading. If necessary, provide overcurrent protection.
 - ▷ When rack mounting, please note that intrinsically harmless leakage currents of the individual power supply units may accumulate, thereby exceeding the allowable limit value. As a remedy, ground the rack via an additional ground connection.
-



Mounting a single receiver in a rack

To mount the receiver in a rack, you will need the GA 3 rack mounting kit (optional accessory).

To fasten the mounting angle of the GA 3 rack mounting kit:

- ▷ Unscrew and remove the two recessed head screws (M4x8) on each side of the receiver.
- ▷ Secure both of the the mounting angles to the sides of the receiver using the previously removed recessed head screws.

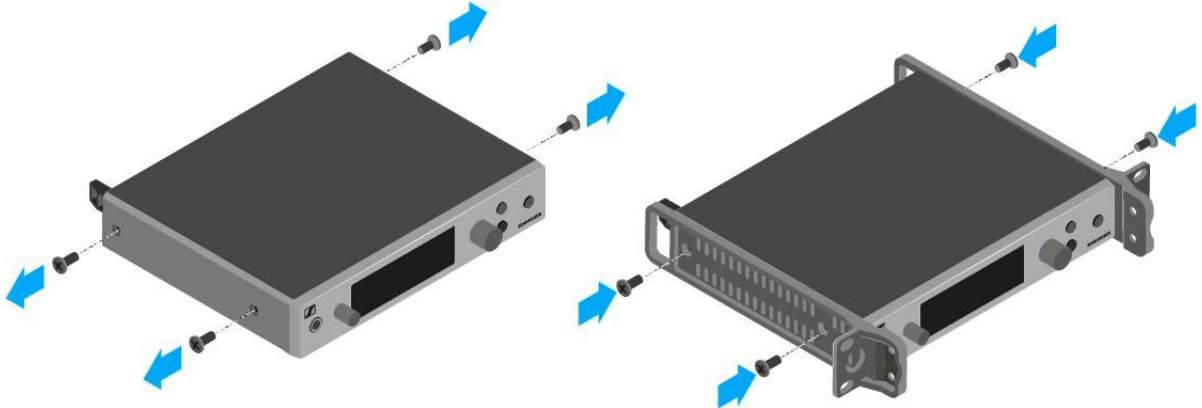

- ▷ Secure the blanking plate to one of the mounting angles using two recessed head screws (M6x10).
- ▷ Attach the AM 2 antenna front mounting set (optional accessory) and mount the rod antennas on the blanking plate (right diagram).

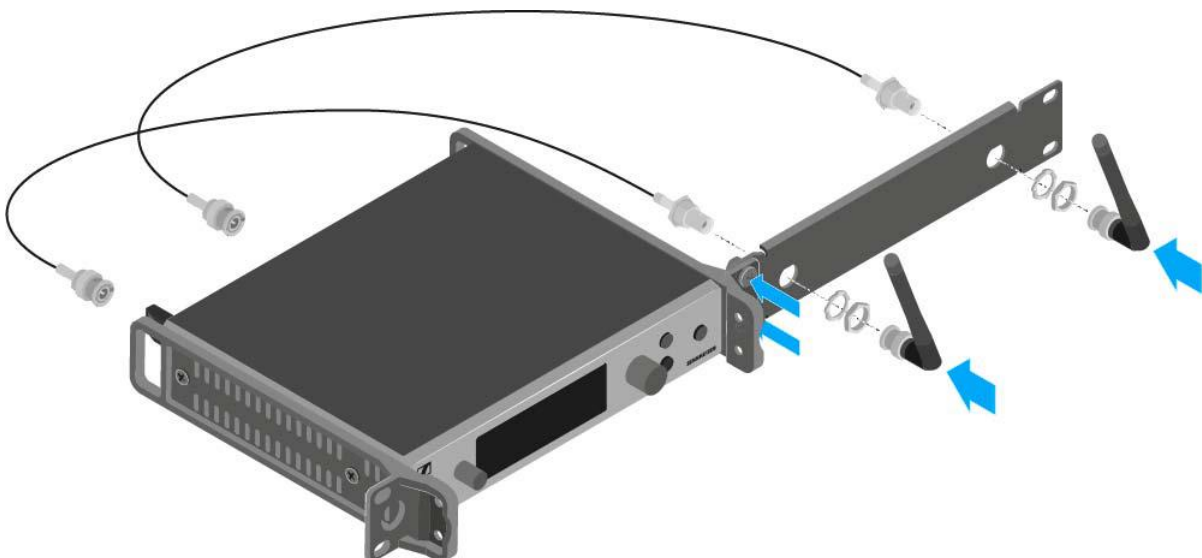

- ▷ Slide the receiver with the mounted blanking plate into the 19" rack.
- ▷ Secure the mounting angle and the blanking plate to the 19" rack.
- ▷ Align the mounted antennas in a V-shape.



Mounting two receivers side by side in a rack

i When you mount two receivers side by side, it is only possible to front mount antennas when you use the ASA 214 antenna splitter in combination with the AM 2 front mounting kit and an additional GA 3 rack mounting kit. See “Installing the ASA 214”.

To mount the receiver using the GA 3 rack mounting kit (optional accessory):

- ▷ Place both receivers upside down and side by side on an even surface.
- ▷ Secure the jointing plate to the transmitters using the six recessed head screws (M3x6).
- ▷ Secure the mounting angle.

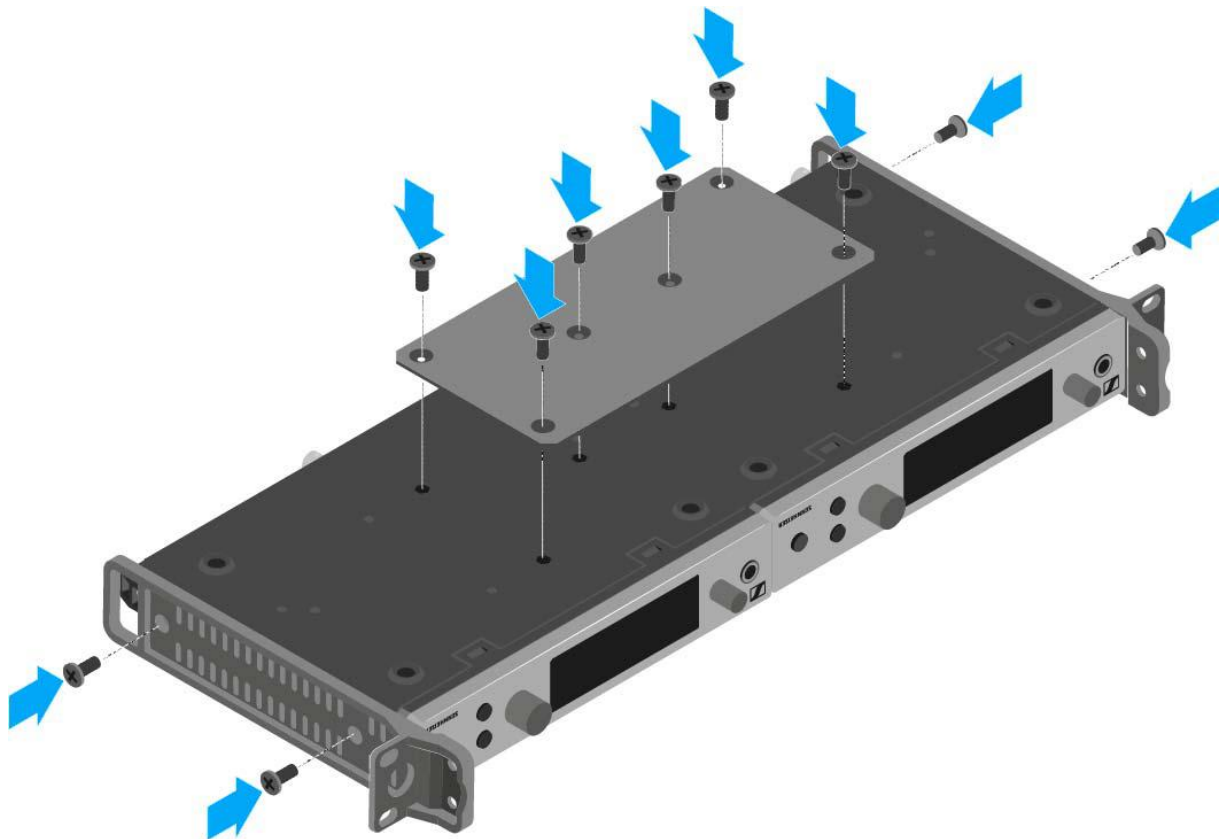



Installing the SKM 300 G4

These sections contain detailed information about installing and starting up the SKM 300 G4.

You can find information about operating the SKM 300 G4 under “Using the SKM 300 G4”.

Inserting and removing the batteries/rechargeable batteries

You can operate the wireless microphone either with batteries (AA, 1.5 V) or with the rechargeable Sennheiser BA 2015 battery.

- ▷ Screw the rear part of the wireless microphone in the direction of the arrow (counter-clockwise) off of the handle of the wireless microphone.

i When you remove the wireless microphone during operation, mute is automatically activated. **MUTE** appears in the display panel. When you screw the microphone back together, mute is deactivated.

- ▷ Pull the rear part of the wireless microphone all the way out.
- ▷ Open the cover of the battery compartment.
- ▷ Place the batteries or the BA 2015 rechargeable battery in the battery compartment as shown on the cover. Please observe correct polarity when inserting the batteries/accupack.

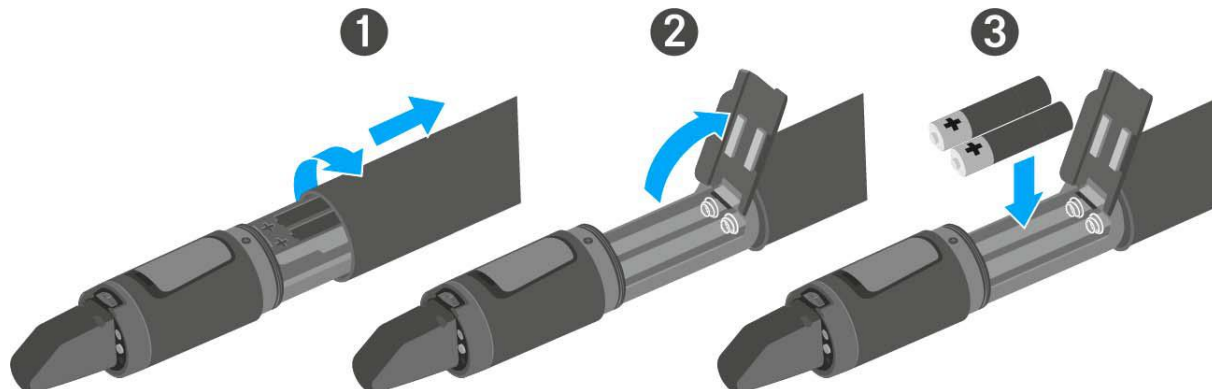

- ▷ Close the cover.
- ▷ Push the battery compartment into the handle of the wireless microphone.
- ▷ Screw the rear part of the wireless microphone back onto the handle.



Battery status

Charge status of the batteries:

	100 %	> 8 h
	70 %	4 - 6 h
	30 %	2 - 3 h
LOW BATT		

Charge status is critical (LOW BATT):

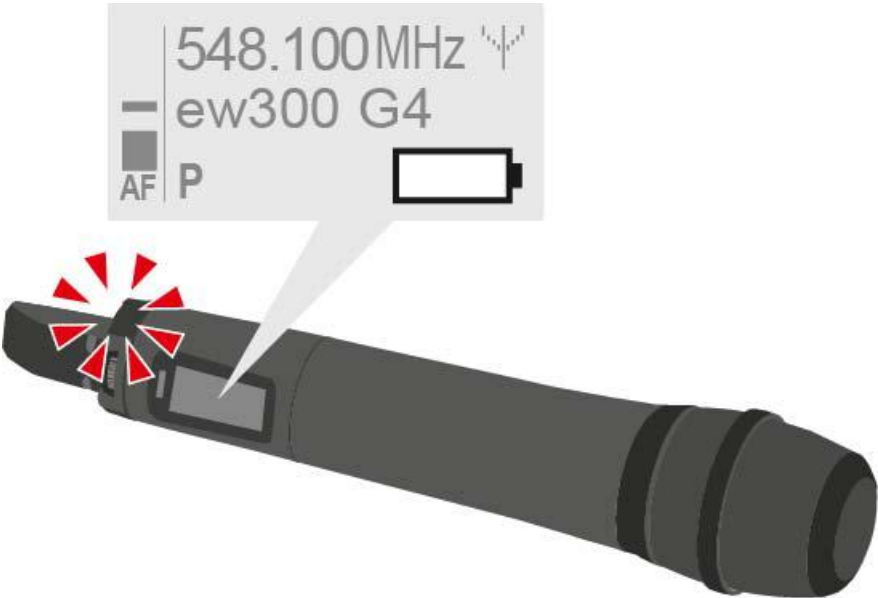



Replacing the microphone module

You can find a list of the recommended microphone modules for the hand-held transmitter under “Microphones and cables”.

To change the microphone module:

- ▷ Unscrew the microphone module.
- ▷ Screw the desired microphone module on.



i Do not touch the wireless microphone contacts or the microphone module contacts. If you touch the contacts, they may become dirty or bent.

When you unscrew the microphone module during operation, mute is automatically activated. **MUTE** appears in the display panel. When you screw the microphone module back on, mute is deactivated.



Changing the colored ring

To change the colored ring:

- ▷ Pull the colored ring off as shown in the diagram.

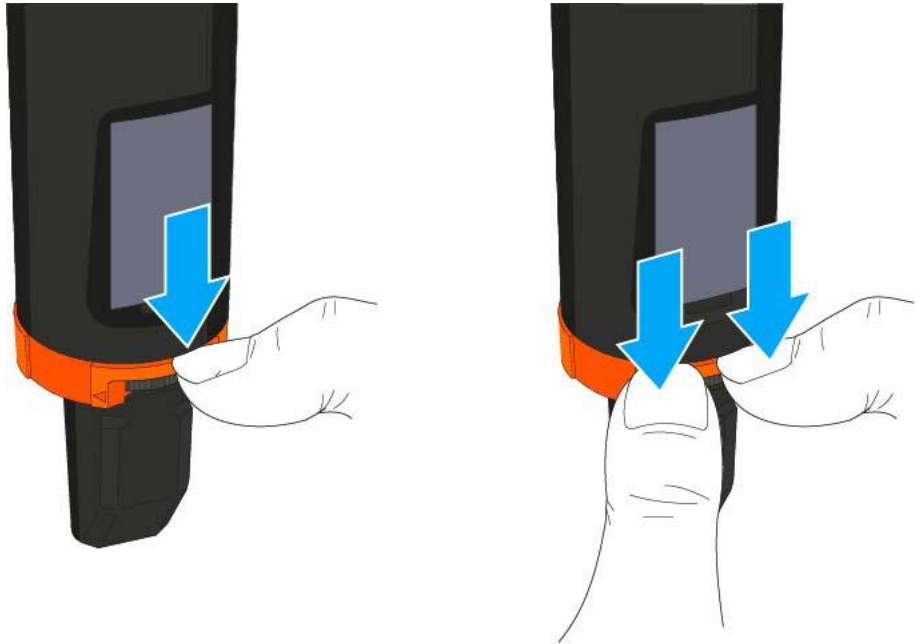

- ▷ Attached a colored ring in the color you want as shown in the diagram.

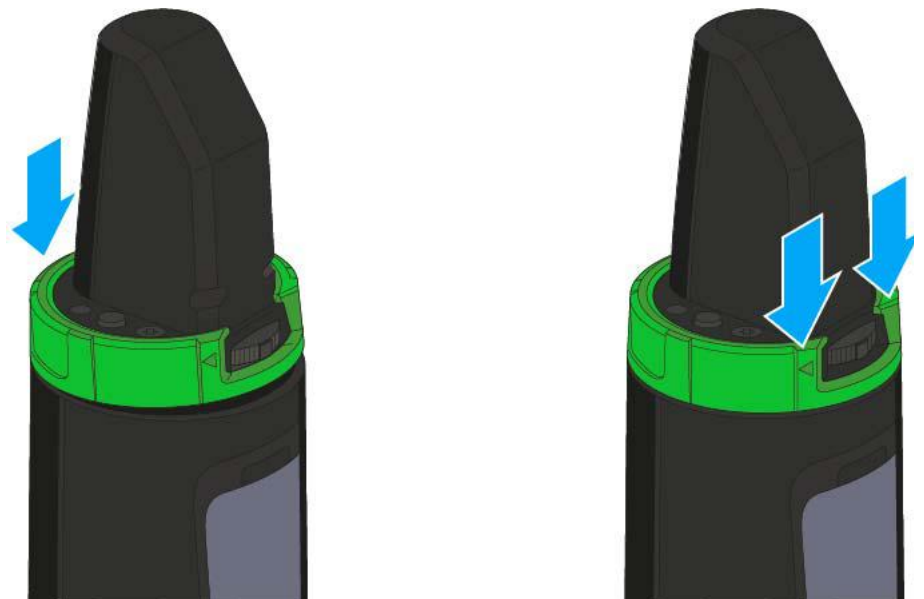



Using the EM 300-500 G4

These sections contain detailed information about using the EM 300-500 G4.

You can find information on installation and startup of the EK 300-500 G4 under “Installing the EM 300-500 G4”.

Operating elements on the front of the device

Product overview for the front of the EM 300-500 G4

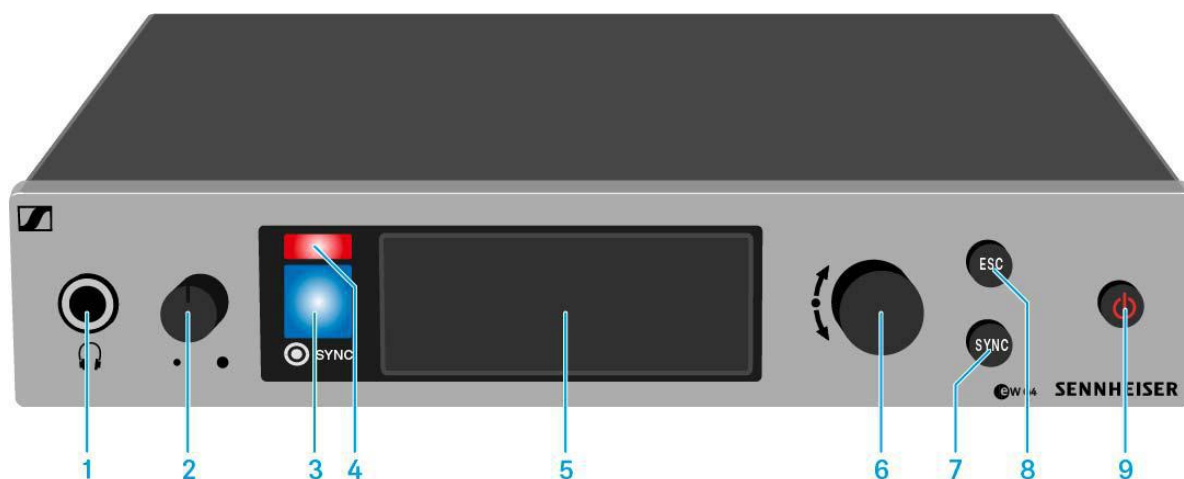

- 1** Headphone socket
 - See “Using the headphone output”
- 2** Volume control for the headphone socket
 - See “Using the headphone output”
- 3** Infrared interface with a blue LED
 - See “Synchronizing devices”
- 4** Red LED for warnings
 - See “Advanced -> Fullscreen Warnings menu item”
- 5** Display panel
 - See “Displays on the EM 300-500 G4 display panel”
- 6** **Jog dial** for navigating through the menu
 - See “Buttons for navigating through the menu”
- 7** **SYNC** button
 - See “Synchronizing devices”
- 8** **ESC** button
 - See “Buttons for navigating through the menu”
- 9** **STANDBY** button
 - See “Switching the EM 300-500 G4 on and off”



Switching the EM 300-500 G4 on and off

To switch the receiver on:

- ▷ Short-press the **STANDBY** button.
The receiver switches on and the **Receiver Parameters** standard display appears.



To switch the receiver to **standby mode**:

- ▷ If necessary, deactivate the lock-off function (see “Lock-off function”).
- ▷ Press and hold the **STANDBY** button until **OFF** appears on the display panel.
The display panel switches off.

To **completely switch** the receiver **off**:

- ▷ Disconnect the receiver from the power supply system by unplugging the power supply unit from the wall socket.



Muting the audio output

To **mute** the audio signal of the receiver:

- ▷ Press the **STANDBY** button in one of the standard displays.
The **RX Mute On?** display appears.
- ▷ Press the **SET** button.
The audio signal is muted.

To **cancel the muting**:

- ▷ Press the **STANDBY** button.
The **RX Mute Off?** display appears.
- ▷ Press the **SET** button.
The audio output is no longer muted.

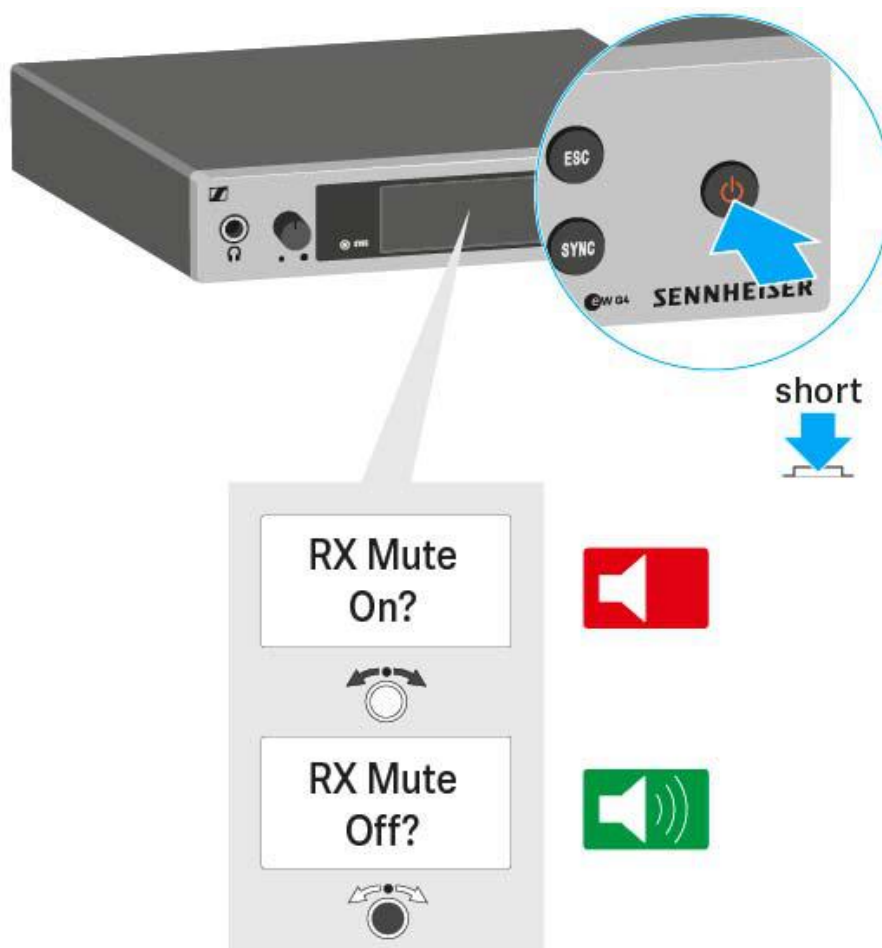



Using the headphone output

You can use the headphone output on the front of the EM 300-500 G4 (6.3 mm jack) to listen to the audio signal.

ATTENTION



Danger due to high volume levels

Volume levels that are too high may damage your hearing.

- ▷ Turn down the volume of the headphone output before you put on the headphone.
- ▷ Increasing the volume of the audio output **AF Out** (see “AF Out menu item”) to more than +18 dB also increases the volume of the headphone output.

-
- ▷ Connect the headphone to the headphone socket.
 - ▷ Control the volume by turning the volume control next to the headphone socket.

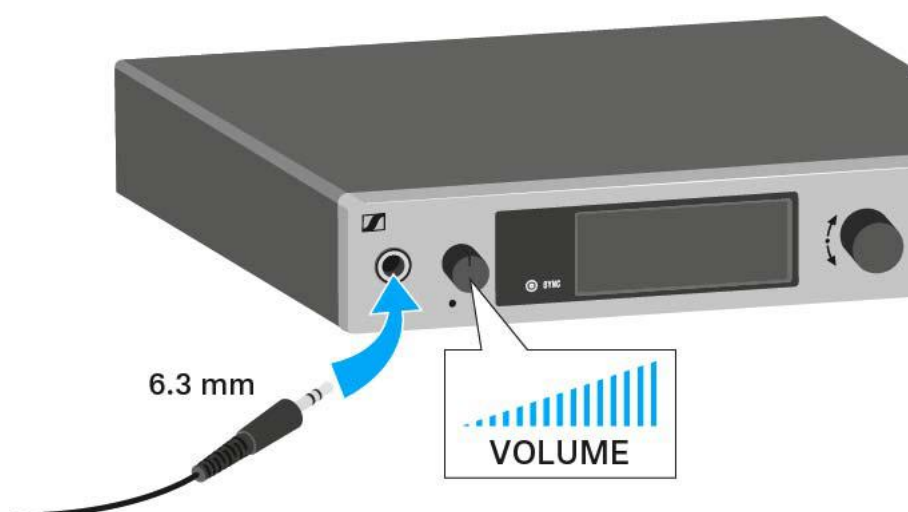



Lock-off function

You can set the automatic lock-off function in the **Auto lock** menu (see “Auto Lock menu item”).

When you have switched on the lock-off function, you will have to turn the receiver off and on again in order to operate it.

To temporarily deactivate the lock-off function:

- ▷ Press the **jog dial**.
Locked appears in the display panel.
- ▷ Turn the **jog dial**.
Unlock? appears in the display panel.
- ▷ Press the **jog dial**.
Lock-off function is now temporarily deactivated.

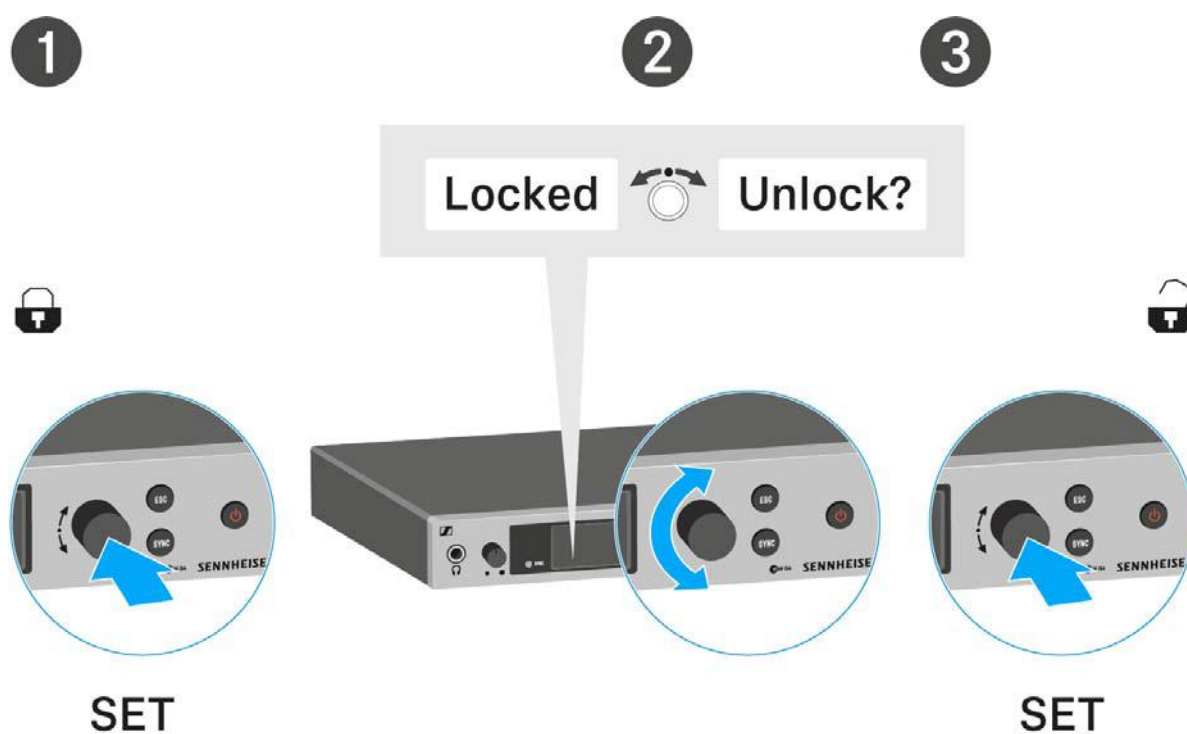

When you are in the operating menu

>> Lock-off function is deactivated long enough for you to work in the operating menu.

When one of the standard displays is shown

>> Lock-off function is automatically activated after 10 seconds.

The lock-off function icon flashes while the lock-off function is being activated again.



Displays on the EM 300-500 G4 display panel

Status information such as reception quality, battery status, audio level, etc. is displayed on the **home screen** of the display panel. See “Home screen”.

The display panel also displays the **operating menu**, which you can use to configure all of the **settings**. See “Setting options in the menu”.



Buttons for navigating through the menu

To navigate through the EM 300-500 G4 operating menu, you need the following buttons.

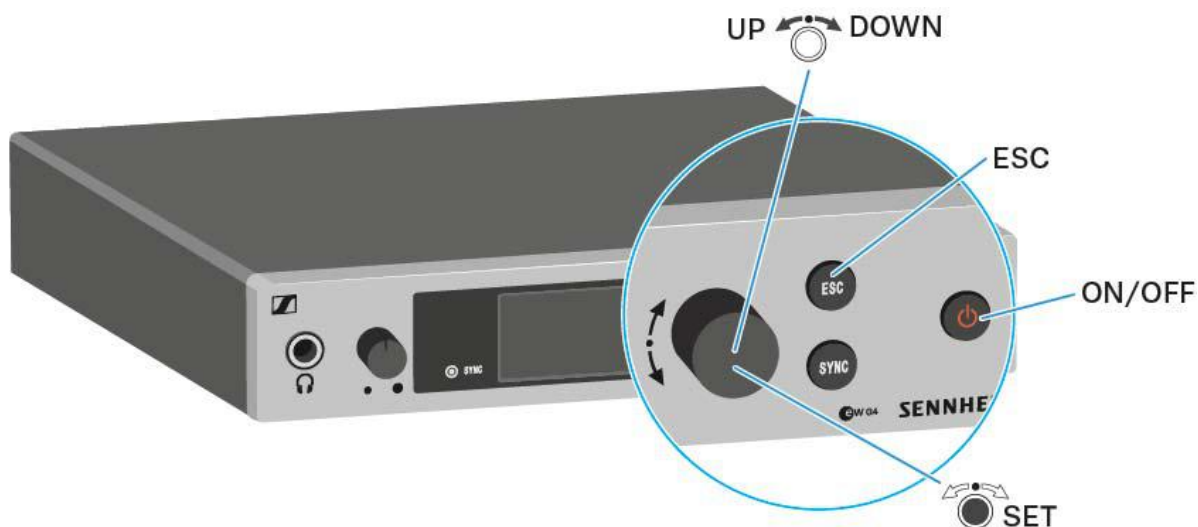

Short-press the **ESC** button

- Cancels the entry and returns to the previous display

Long-press the **ESC** button

- Cancels the entry and returns to the home screen



Press the **jog dial**

- Changes from the current standard display to the operating menu
- Calls up a menu item
- Changes to a submenu
- Stores the settings and returns to the operating menu



Turn the **jog dial**

- Selects a standard display (see “Home screen”)
- Changes to the previous or next menu item
- Changes the setting of a menu item



Home screen

After you switch on the receiver, the display panel initially displays the Sennheiser logo. After a short time, the home screen is then displayed.

The home screen has three different standard displays.

- On the home screen, turn the **jog dial** to switch between the standard displays.

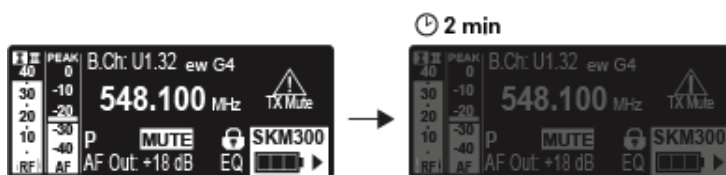

The display is dimmed automatically after 2 minutes of inactivity.



If there is no radio link to a transmitter, the display switches off after 20 minutes. The display can be reactivated by pressing any button.



Receiver Parameters standard display

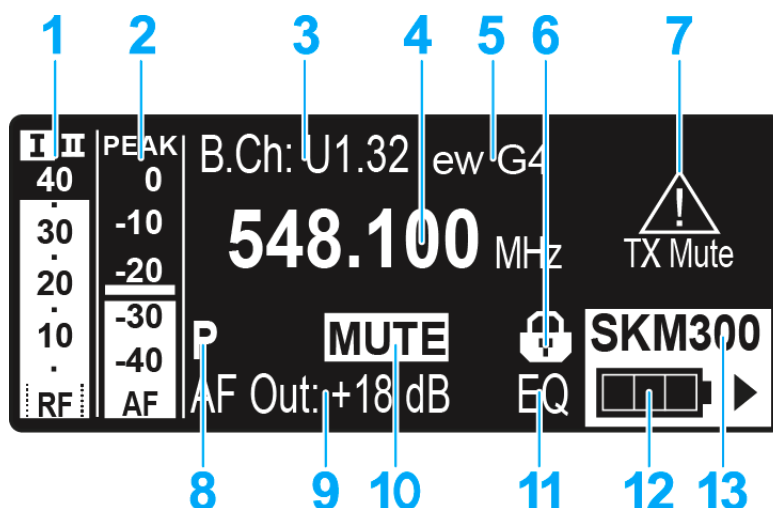

- 1 RF** RF level (radio frequency)
 - RF signal level display
 - including the display of the squelch threshold (see “Squelch menu item”)
- 2 AF** audio level (audio frequency)
 - Displays the audio level of the received transmitter
When the display shows full deflection, the audio input level is excessively high. When the transmitter is overloaded frequently or for extended periods of time, the **PEAK** display is shown inverted.
 - See “AF Out menu item”
- 3** Frequency bank and channel
 - Current frequency bank and channel number
 - See “Frequency Preset menu item”
- 4** Frequency
 - Current receiving frequency
 - See “Frequency Preset menu item”
- 5** Name
 - Freely selectable name of the receiver
 - See “Name menu item”
- 6** Lock-off function
 - Lock-off function is activated on the receiver
 - See “Lock-off function”
- 7** Warnings
 - Activated warning messages are displayed
 - See “Advanced -> Fullscreen Warnings menu item”
- 8 P** pilot tone
 - Activated pilot tone evaluation
 - See “Advanced -> Pilot Tone menu item”
- 9** Output gain
 - Current output gain of the audio frequency signal at the 6.3 mm socket / XLR socket
 - See “AF Out menu item”

**10** Equalizer setting

- Current equalizer setting
- See “Equalizer menu item”

11 MUTE muting function

- Receiver or transmitter is muted
- See “Muting the audio output”

12 Battery status of the transmitter

- SKM 300 G4: see “Inserting and removing the batteries/rechargeable batteries”
- SKM 500 G4: see “Inserting and removing the batteries/rechargeable batteries”
- SK 300 G4: see “Inserting and removing the batteries/rechargeable batteries”
- SK 500 G4: see “Inserting and removing the batteries/rechargeable batteries”

13 Transmitter type

- Product name of the connected transmitter

Transmitter Parameters [standard display](#)

The Transmitter Parameters standard display shows the microphone module (only for SKM) and the transmitter type.

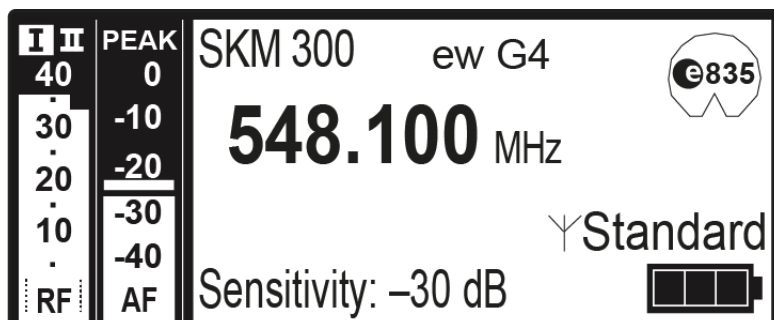



Soundcheck standard display

The Soundcheck standard display shows the transmission quality between the transmitter and the receiver.

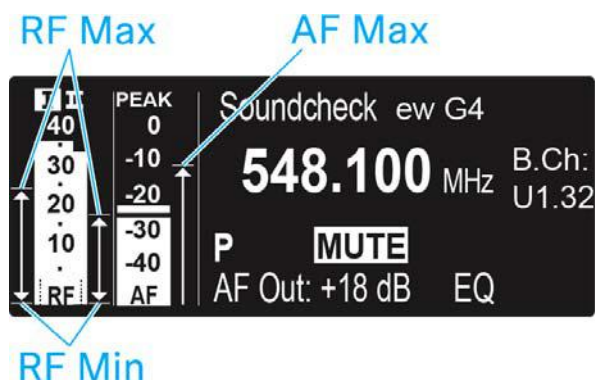

By doing a soundcheck, you can ensure adequate transmission quality in the entire area in which you want to use the transmitter. You can do the soundcheck without the help of another person.

- ▷ With the transmitter, walk up and down the area in which you want to use the transmitter.

The receiver records the following parameters:

RF Min

- Minimum RF signal level
- must be well above the squelch threshold level for one of the two antennas

Ways to optimize

- ▷ Check that the antennas and the antenna cables are correctly connected.
- ▷ Improve the position of the antennas.
- ▷ If necessary, use an antenna booster.

RF Max

- Maximum RF signal level
- both antennas should reach 40 dBμV

Ways to optimize

- ▷ Check that the antennas and the antenna cables are correctly connected.
- ▷ Improve the position of the antennas.
- ▷ If necessary, use an antenna booster.

AF Max

- Maximum audio level

Ways to optimize

- ▷ On your transmitter, adjust the audio level as high as possible without the display for the audio level showing full deflection (**AF Max** is at a level with the **PEAK** display), see “AF Out menu item”.



Menu structure

The figure shows the complete EM 300-500 G4 menu structure in an overview.

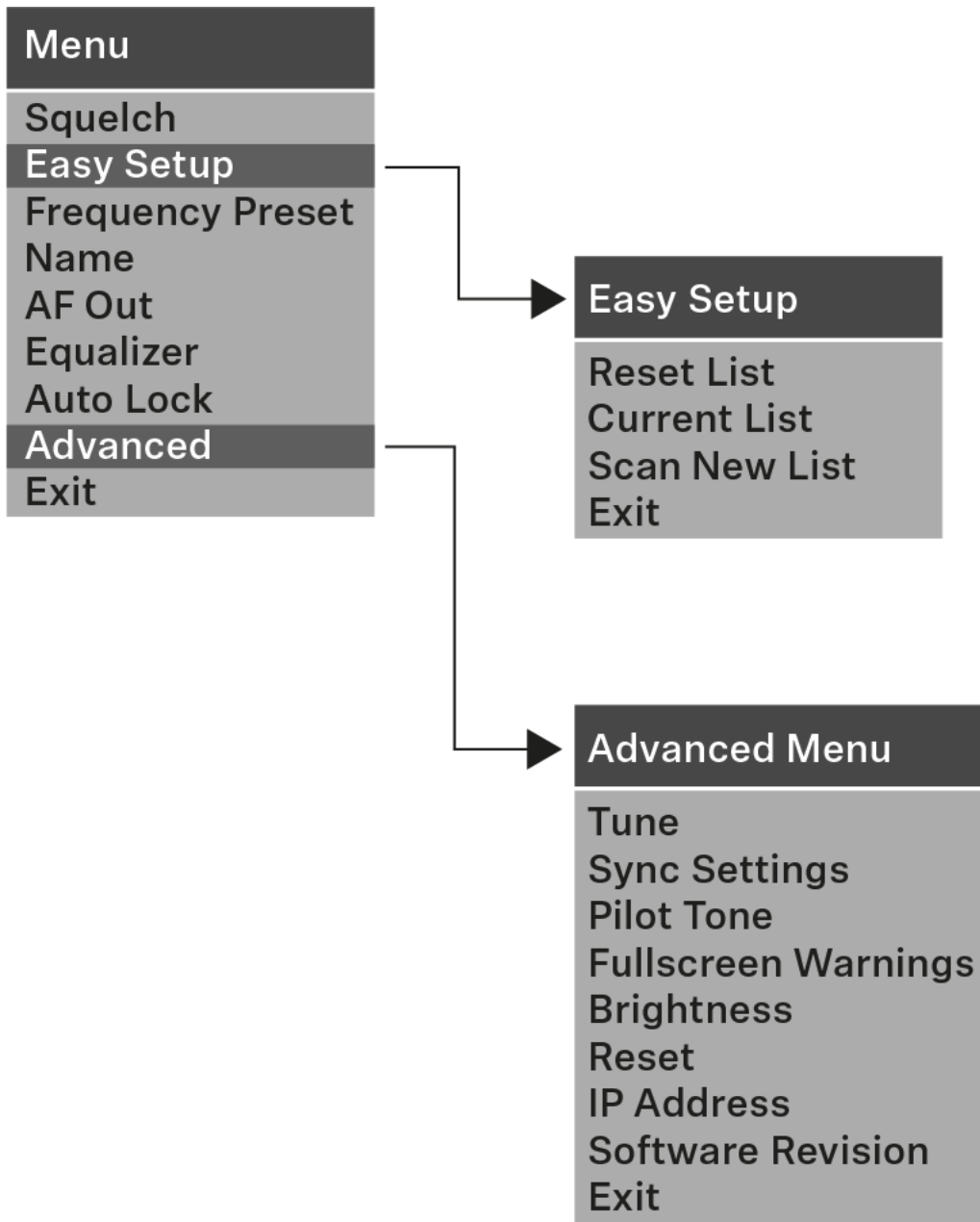



Squelch menu item

You can adjust the squelch threshold in the **Squelch** menu item.

Setting range:

- 5 to 25 dB μ V, adjustable in 2-dB steps

The squelch threshold is displayed on the home screen in the RF signal level area.

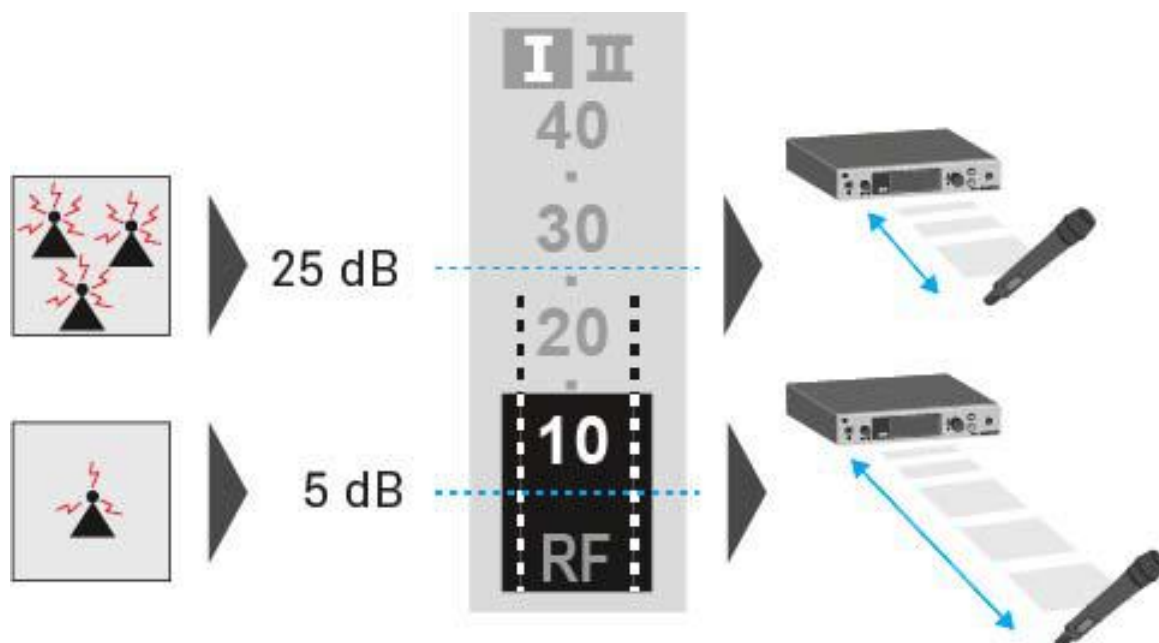

CAUTION

Risk of hearing and material damage

If you set the squelch threshold to a very low value, a very loud hissing noise can occur in the receiver. This hissing noise can be loud enough to cause hearing damage or overload your system's loudspeakers.

- ▷ Before adjusting the squelch threshold, set the volume of the audio output to the minimum.
 - ▷ Never change the squelch threshold during a live transmission.
-



To open the **Squelch** menu item:

- ▷ On the home screen, press the **jog dial** to open the operating menu.
- ▷ Turn the **jog dial** until the Squelch menu item appears in the selection frame.
- ▷ Press the **jog dial** to open the menu.
- ▷ Adjust the settings as desired.



- ▷ Press the **jog dial** to save your selection.
- or
- ▷ Press the **ESC** button to cancel the entry without saving the setting.



Easy Setup menu item

You can scan for unused frequencies using the **Easy Setup** menu item.

When you have connected multiple EM 300-500 G4 devices to a network via the RJ-45 interfaces (see “Creating a data network”), you can perform the frequency setup for all of the connected receivers.

 Switch off all transmitters before you perform the scan. If transmitters are still switched on, they are detected as unavailable frequencies and the frequencies that are actually available cannot then be used.

To open the **Easy Setup** menu item:

- On the home screen, press the **jog dial** to open the operating menu.
- Turn the **jog dial** until the **Easy Setup** menu item appears in the selection frame.
- Press the **jog dial** to open the menu.

Scan New List



- Select **Scan New List** to scan for unused frequencies.
- Press the **jog dial** to start the scan.
The frequency range of the receiver is scanned. As a result, the number of unused frequencies is displayed for every frequency bank.
- Turn the **jog dial** to select a frequency bank.
- Press the **jog dial** to confirm your selection.
- Turn the **jog dial** to select an unused frequency from the selected bank.
- Press the **jog dial** to save your selection and synchronize the selected frequency with the transmitter at a later point (see “Synchronizing devices”).

or



- ▷ Press the **SYNC** button to synchronize the selected frequency with the transmitter immediately.

Current List

- ▷ Select **Current List** to show the list of unused frequencies from the last scan.

Reset

- ▷ Select **Reset List** to delete the list of unused frequencies.

Performing multi-channel frequency setup

i As an alternative to the following procedure, multi-channel frequency setup can also be performed using the **Sennheiser Wireless Systems Manager (WSM)** software. For more information about controlling devices via the **Sennheiser Wireless Systems Manager (WSM)** software, refer to the instruction manual for the software. You can download the software here:

www.sennheiser.com/wsm

To perform the automatic frequency setup for multiple radio links simultaneously:

- ▷ Connect all of the receivers to one network using a network switch. See “Creating a data network”.
- ▷ Please note that all receivers must be in the same **IP address range**.
 - The IP addresses can be **automatically** assigned if there is a DHCP server in the network.
 - If there is no DHCP server in the network, the IP addresses must be assigned **manually**. See “Advanced -> IP Address menu item”.
 - Assign the IP addresses for all receivers in the **192.168.x.x** range (the link-local range **169.254.x.x** is also a possible alternative).
- ▷ Open the **Easy Setup** menu item on one of the receivers. This receiver is the master. You can choose any receiver to be the master.



- ▷ Perform the frequency scan on the master receiver as described above.
- ▷ From the scan results in the master receiver, select a frequency bank with enough free channels.

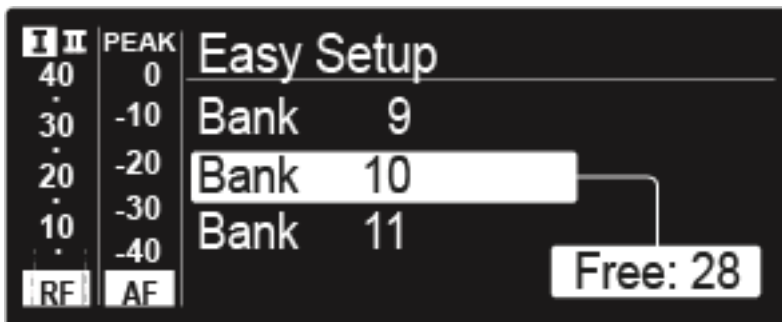

After you make your selection, the display panels of the other receivers will display the message [Assign New Frequency?](#).

Receivers with non-compatible frequency ranges will display the message [Unassignable Frequency!](#).

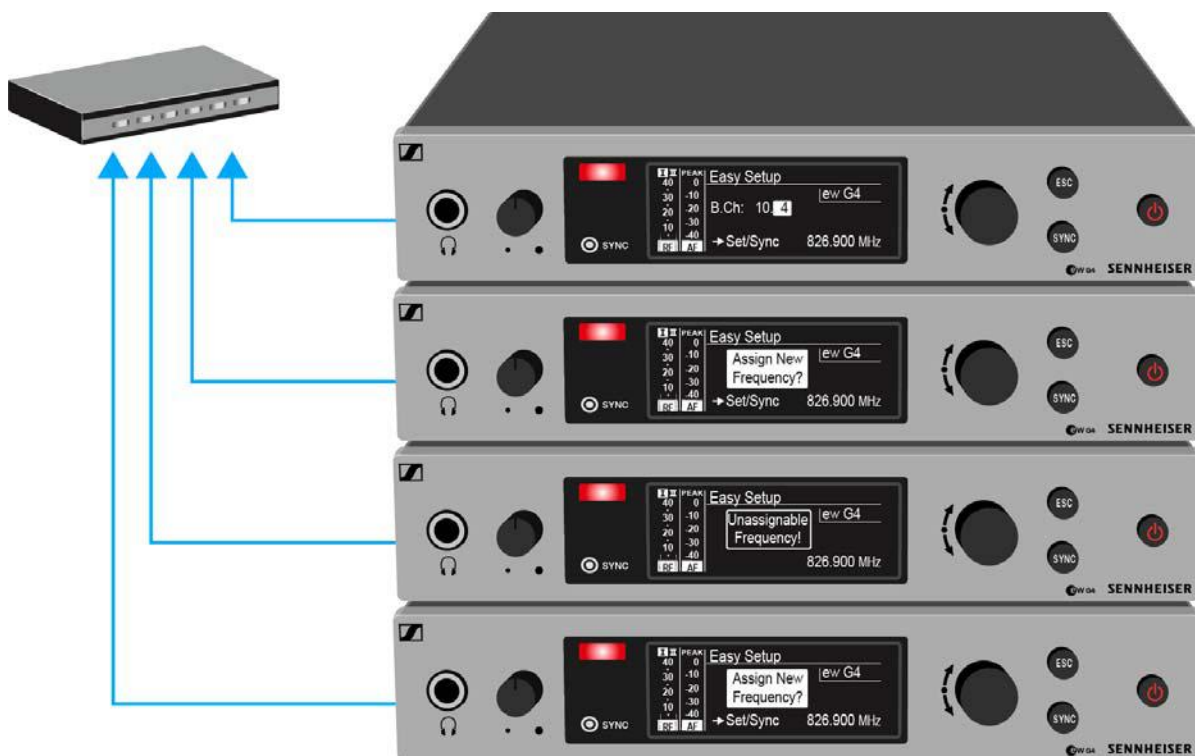



- ▷ Select an unused frequency for one of the connected receiver on the master receiver.

The frequency selected on the master receiver will also be shown on the display panel of the connected receivers.

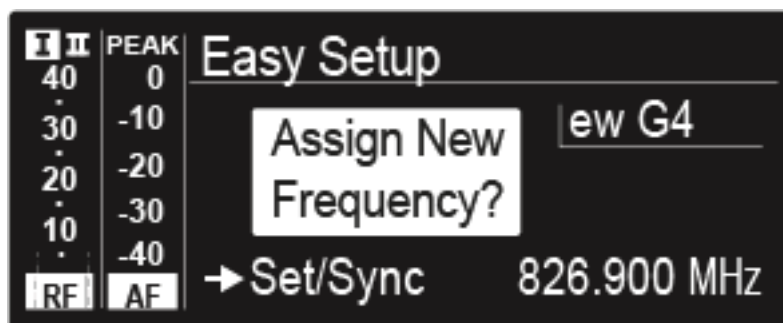

- ▷ Press the jog dial (**SET**) on the particular receiver to save your selected frequency and synchronize it with the corresponding transmitter at a later point (see “Synchronizing devices”).

or

- ▷ Press the **SYNC** button to synchronize the selected frequency with the transmitter immediately.
- ▷ Use this procedure to assign an unused frequency to all connected receivers, one after another.
- ▷ For the last step, assign a frequency to the master receiver. This completes the multi-channel frequency setup.



Frequency Preset menu item

In the **Frequency Preset** menu item, you can adjust the receiving frequency of the receiver by adjusting the frequency bank and the channel.

To open the **Frequency Preset** menu item:

- ▷ On the home screen, press the **jog dial** to open the operating menu.
- ▷ Turn the **jog dial** until the **Frequency Preset** menu item appears in the selection frame.
- ▷ Press the **jog dial** to open the menu.
- ▷ Adjust the settings as desired.

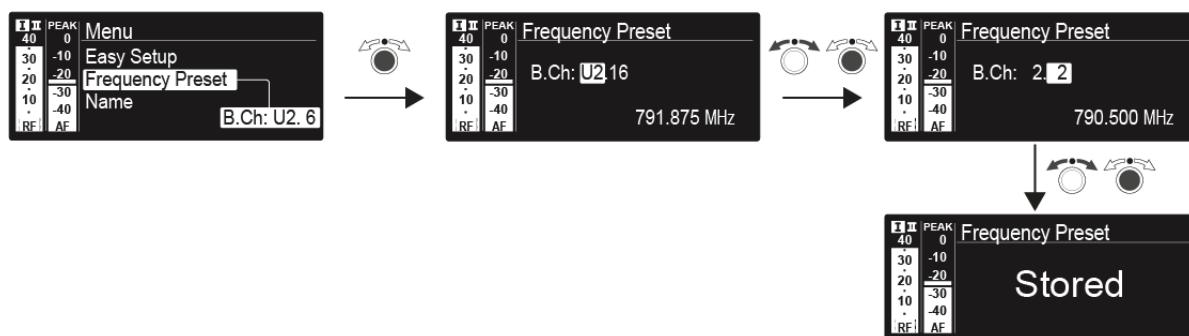

- ▷ Press the **jog dial** to save your selection.
- or
- ▷ Press the **ESC** button to cancel the entry without saving the setting.

i You can set the frequencies of the frequency bank **U** here: “Advanced -> Tune menu item”



Name menu item

In the **Name** menu item you can enter a name for the radio link.

To open the **Name** menu item:

- ▷ On the home screen, press the **jog dial** to open the operating menu.
- ▷ Turn the **jog dial** until the **Name** menu item appears in the selection frame.
- ▷ Press the **jog dial** to open the menu.
- ▷ Adjust the settings as desired.

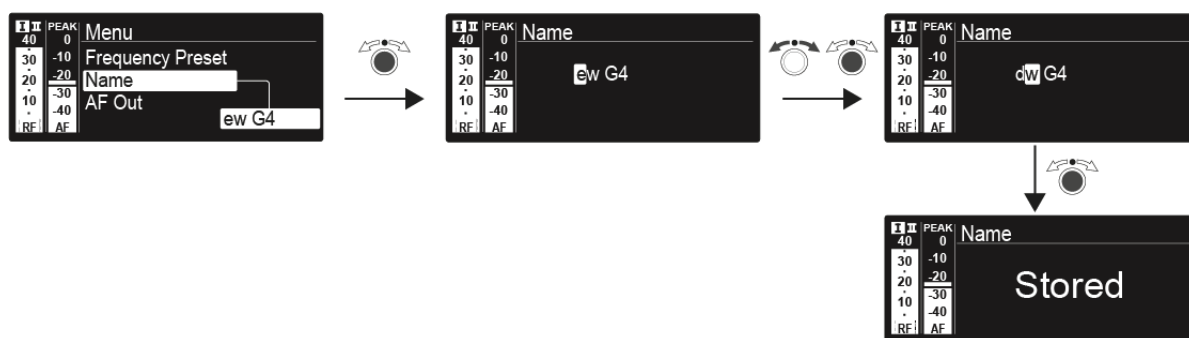

- ▷ Press the **jog dial** to save your selection.
- or
- ▷ Press the **ESC** button to cancel the entry without saving the setting.



AF Out menu item

In the **AF Out** menu item, you can set the audio level that is output via the receiver audio outputs.

Setting range:

- -24 dB to +24 dB in 3 dB steps

To open the **AF Out** menu item:

- ▷ On the home screen, press the **jog dial** to open the operating menu.
- ▷ Turn the **jog dial** until the **AF Out** menu item appears in the selection frame.
- ▷ Press the **jog dial** to open the menu.
- ▷ Adjust the settings as desired.

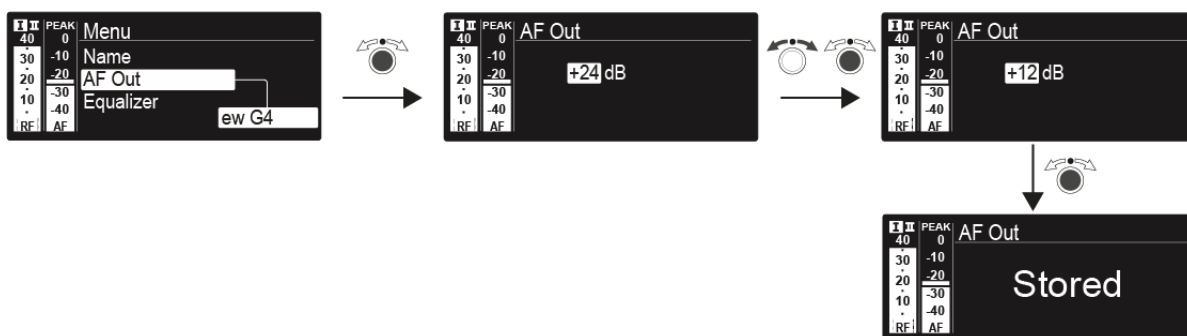

- ▷ Press the **jog dial** to save your selection.
- or
- ▷ Press the **ESC** button to cancel the entry without saving the setting.



Equalizer menu item

In the **Equalizer** menu item, you can change the frequency response of the output signal. You can reduce the bass range and boost the treble range.

To open the **AF Out** menu item:

- ▷ On the home screen, press the **jog dial** to open the operating menu.
- ▷ Turn the **jog dial** until the **AF Out** menu item appears in the selection frame.
- ▷ Press the **jog dial** to open the menu.
- ▷ Adjust the settings as desired.

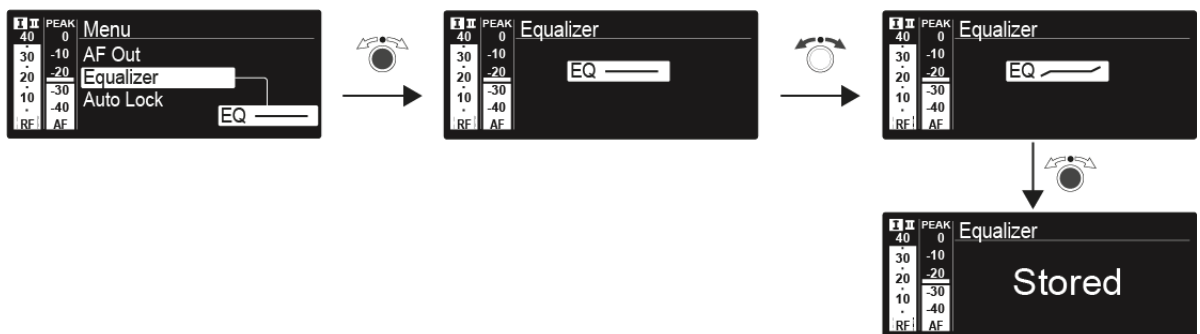

- ▷ Press the **jog dial** to save your selection.
- or
- ▷ Press the **ESC** button to cancel the entry without saving the setting.



Auto Lock menu item

In the **Auto Lock** menu item you can activate or deactivate the auto lock-off function.

i You can find information about temporarily deactivating the lock-off function during operation under “Lock-off function”.

To open the **Auto Lock** menu item:

- ▷ On the home screen, press the **jog dial** to open the operating menu.
- ▷ Turn the **jog dial** until the **Auto Lock** menu item appears in the selection frame.
- ▷ Press the **jog dial** to open the menu.
- ▷ Adjust the settings as desired.

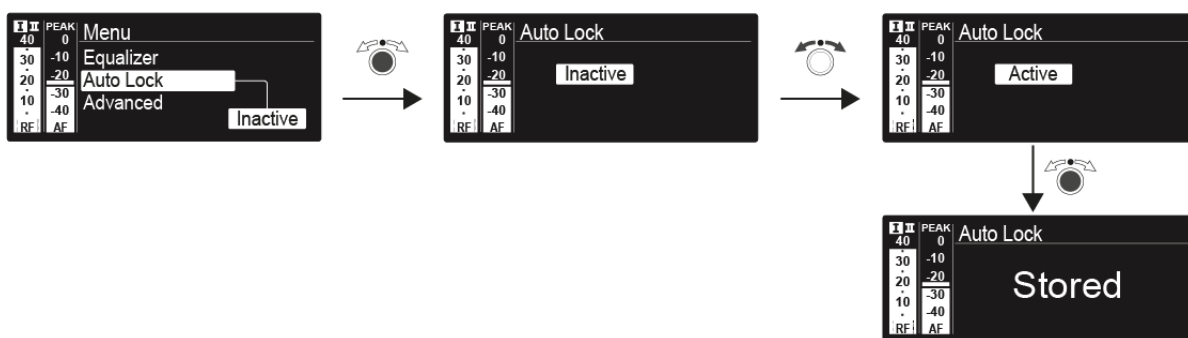

- ▷ Press the **jog dial** to save your selection.
- or
- ▷ Press the **ESC** button to cancel the entry without saving the setting.



Advanced -> Tune menu item

In the **Tune** menu item of the **Advanced** submenu, you can configure the receiving frequencies for the frequency banks **U1** to **U6**.

You can save a total of 32 frequencies in the **U** frequency bank.

Only adjusting the frequency

Open the **Tune** menu item in the **Advanced** menu.

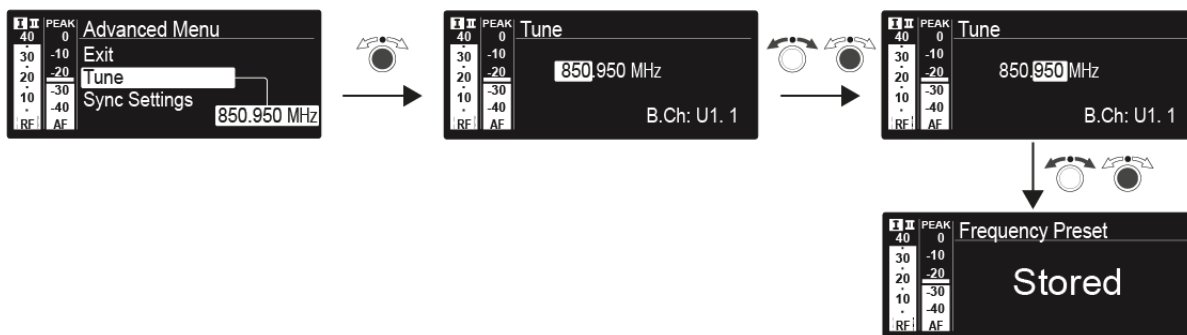

- ▷ Press the **jog dial** to save your selection.
or
- ▷ Press the **ESC** button to cancel the entry without saving the setting.

Setting the channel and frequency

- ▷ Select the **Tune** menu item and call it up by holding down the **SET** button until the channel selection appears.
- ▷ Adjust the settings.

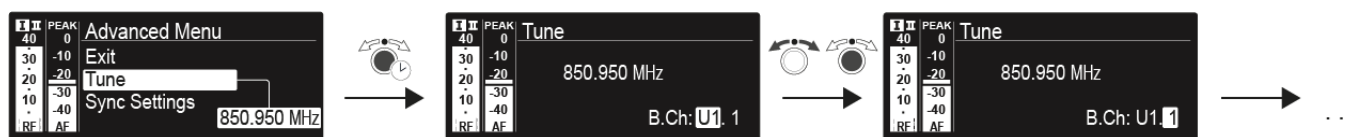

- ▷ Press the **jog dial** to save your selection.
or
- ▷ Press the **ESC** button to cancel the entry without saving the setting.



Advanced -> Sync Settings menu item

In the **Sync Settings** menu item of the **Advanced** submenu, you can configure the parameters to be sent to the transmitters and activate or deactivate transmission. The parameters are defined separately for the SK, SKM and SKP.

You can activate/deactivate the following parameters:

- Sensitivity
- Auto Lock
- Mute Mode
- RF Power
- Phantom Power 48 V (only SKP)

To configure a parameter and activate or deactivate transmission:

- ▷ Go to the parameter in question in the **Advanced -> Sync Settings** menu.
- ▷ Press the **jog dial** to open the sub-item.
- ▷ Turn the **jog dial** to set the value.
- ▷ Press the **jog dial** to save your setting.
- ▷ Turn the **jog dial** to activate or deactivate the check box.

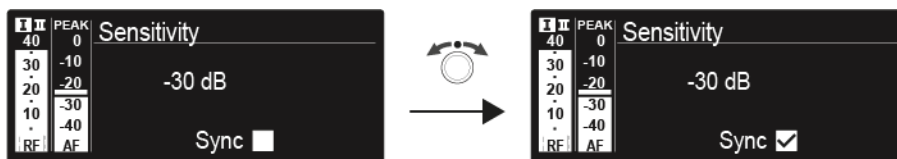

When the check box is activated, the value will be transmitted during synchronization. If it is deactivated, the value will not be transmitted.

- ▷ Press the **jog dial** to save your setting.

Advanced -> Pilot Tone menu item

In the **Pilot Tone** menu item of the **Advanced** submenu, you can activate and deactivate the pilot tone evaluation.



The pilot tone has an inaudible frequency that is sent from the transmitter and evaluated by the receiver. It supports the receiver's squelch function.



Advanced -> Fullscreen Warnings menu item

In the **Warnings** menu item of the **Advanced** submenu, you can activate or deactivate warnings for certain cases. The warning in question will flash across the entire screen.

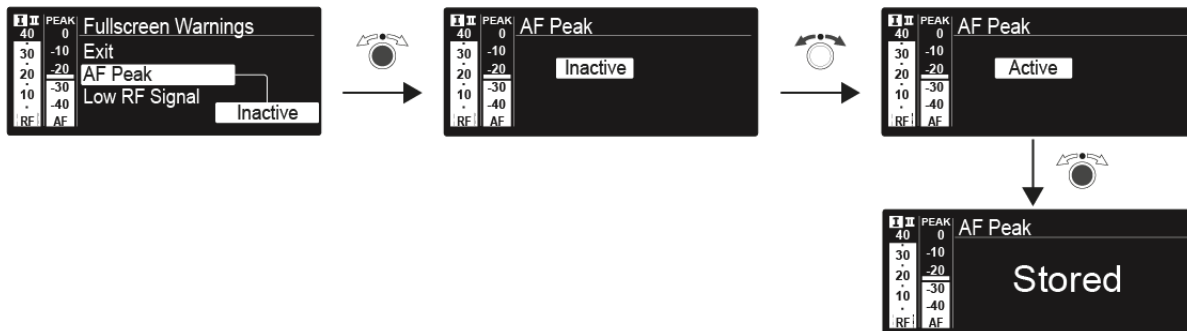

You can activate or deactivate the following warnings:

AF Peak

- The audio level is too high.

Low RF Signal

- The RF signal is too weak.

RF Mute

- The RF signal from the transmitter to the receiver is deactivated.

TX Mute

- The transmitter audio signal is muted.

RX Mute

- The receiver audio output is muted.

Low battery

- The battery charge of the transmitter is low.

Advanced -> Brightness menu item

In the **Brightness** menu item of the **Advanced** submenu, you can adjust the display contrast of the display panel.





Advanced -> Reset menu item

In the **Reset** menu item of the **Advanced** submenu, you can reset the settings of the receiver.

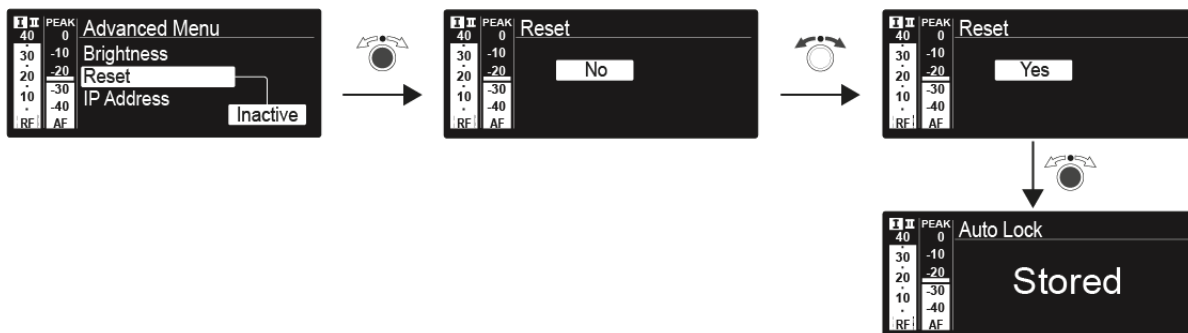

Advanced -> IP Address menu item

In the **IP Address** menu item of the **Advanced** submenu, you can configure the IP addresses.

The IP addresses can be obtained automatically (automatic) or entered manually (manual).

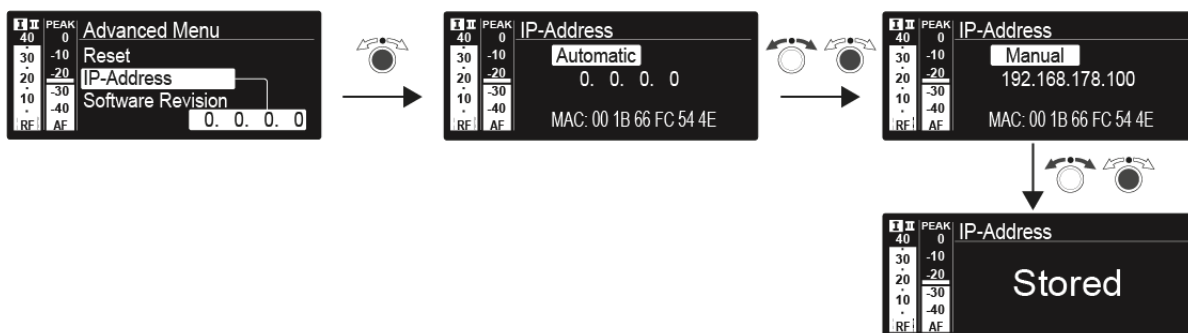

Advanced -> Software Revision menu item

In the **Software Revision** menu item of the **Advanced** submenu, you can display the current software version of the receiver.



Using the SKM 300 G4

These sections contain detailed information about using the SKM 300 G4.

You can find information on installation and startup of the SKM 300 G4 under “Installing the SKM 300 G4”.

Operating elements of the SKM 300 G4 handheld transmitter

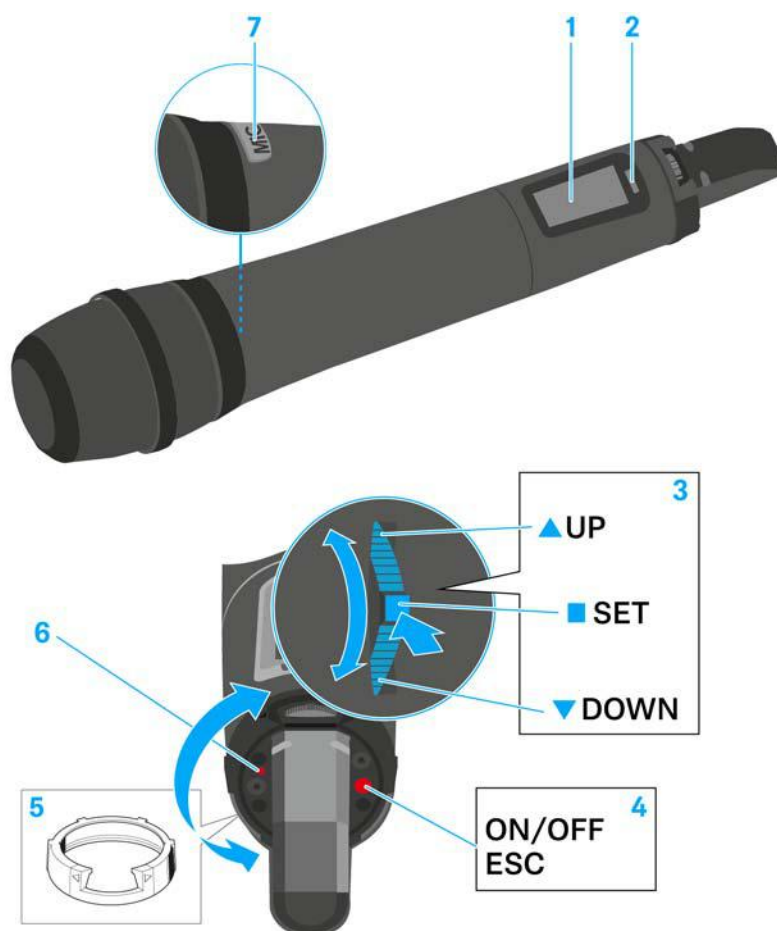

- 1** Display panel
 - See “Displays on the SKM 300 G4 handheld transmitter display panel”
- 2** Infra-red interface
 - See “Synchronizing devices”
- 3** **DOWN**, **UP** and **SET** multi-function switch
 - See “Buttons for navigating the SKM 300 G4 menu”
- 4** **ON/OFF** button with **ESC** function in the operating menu
 - Switch the transmitter on or off
See “Switching the SKM 300 G4 handheld transmitter on and off”
 - Escape function in the menu
See “Buttons for navigating the SKM 300 G4 menu”
 - Deactivating the RF signal
See “Deactivating the RF signal (RF mute)”



5 Colored ring

- Available in different colors (see “Additional accessories” and “Changing the colored ring”)
- Can be turned to protect the multi-function switch

6 Operation and battery indicator, red LED

- illuminated = ON
See “Switching the SKM 300 G4 handheld transmitter on and off”
- flashing = LOW BATTERY
See “Inserting and removing the batteries/rechargeable batteries”

7 MIC button

- See “Muting the handheld transmitter (AF mute)”
- See “Deactivating the RF signal (RF mute)”
- See “Advanced > Mute Mode menu item”

Switching the SKM 300 G4 handheld transmitter on and off

To switch on the SKM 300 G4:

- Hold down the **ON/OFF** button until the Sennheiser logo appears on the display.

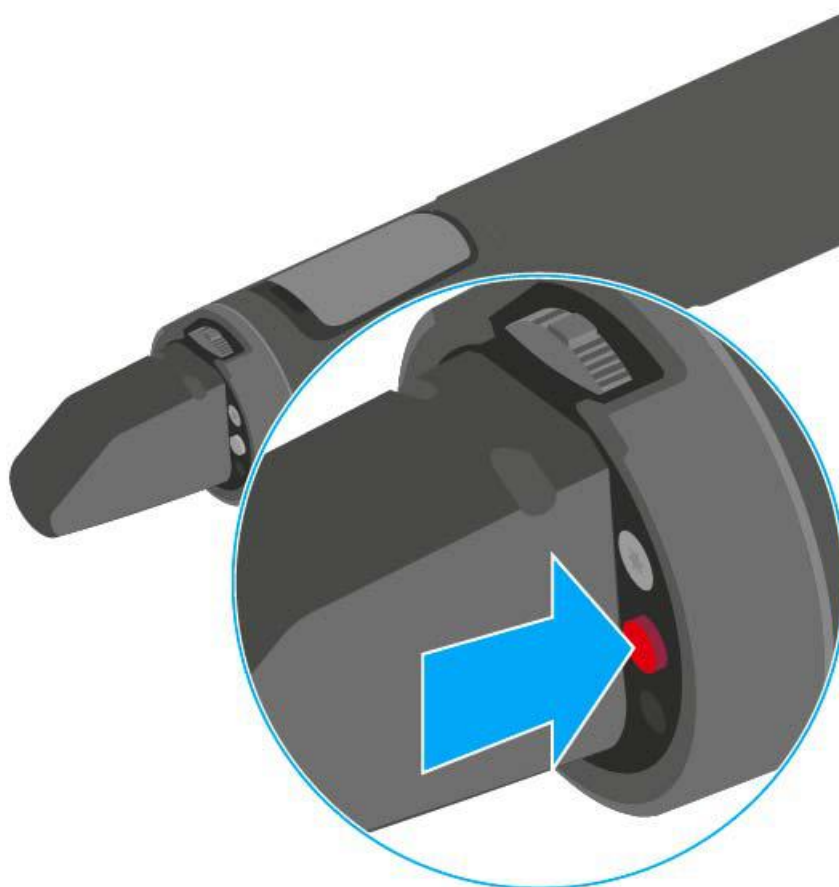

To switch off the SKM 300 G4:

- Hold down the **ON/OFF** button until the display goes off.



Muting the handheld transmitter (AF mute)

You can mute the audio signal by pressing the **MIC** button.

To do this, the **MIC** button function must be configured to **AF On/Off**. You can find more information about this subject under “Advanced > Mute Mode menu item”.

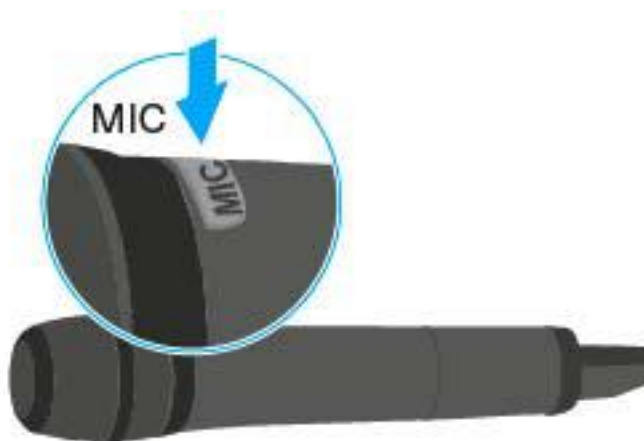

Furthermore, you can configure whether the **MIC** button should light up red and when. You can find more information about this subject under “Advanced > MIC LED menu item”.



Deactivating the RF signal (RF mute)

You can deactivate the RF signal in two ways:

Deactivating the RF signal with the **MIC** button

You can mute the RF signal by pressing the **MIC** button.

To do this, the **MIC** button function must be configured to **RF On/Off**. You can find more information about this subject under “Advanced > Mute Mode menu item”.

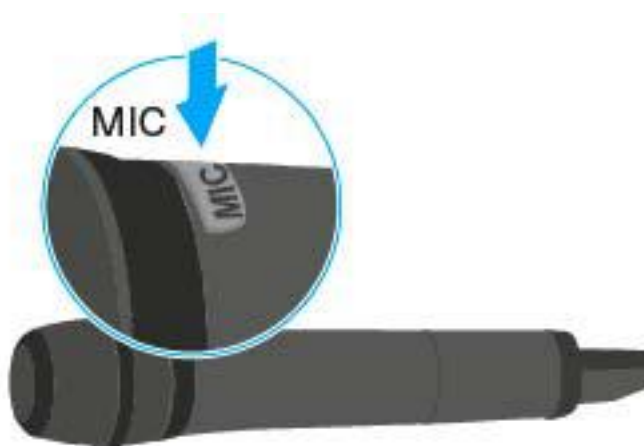

Furthermore, you can configure whether the **MIC** button should light up red and when. You can find more information about this subject under “Advanced > MIC LED menu item”.



Deactivating the RF signal with the **ON/OFF** button

You can deactivate the RF signal with the **ON/OFF** button.

To deactivate the RF signal:

- ▷ Press the **ON/OFF** button.
RF Mute On? appears.
- ▷ Press the **SET** button.

The transmission frequency is displayed, however the wireless microphone is not transmitting an RF signal. The transmission icon is not lit (see “Displays on the SKM 300 G4 handheld transmitter display panel”).

To **activate** the RF signal:

- ▷ Press the **ON/OFF** button.
RF Mute Off? appears.
- ▷ Press the **SET** button.

The transmission icon appears again (see “Displays on the SKM 300 G4 handheld transmitter display panel”).

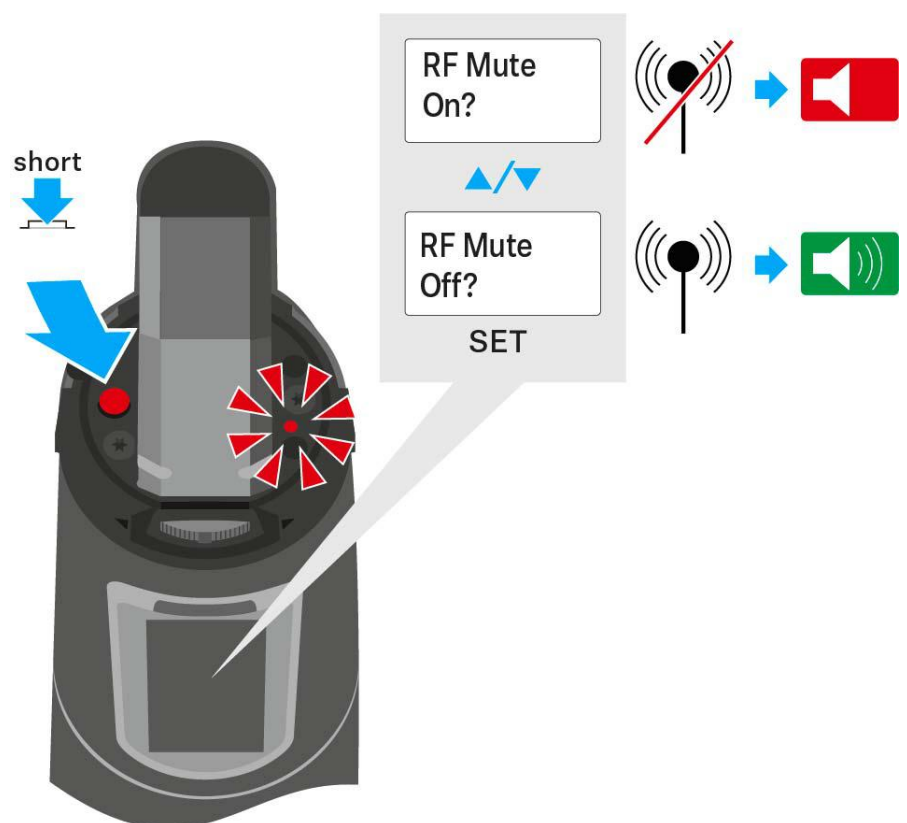



Lock-off function

You can set the automatic lock-off function in the **Auto lock** menu (see “Auto Lock menu item”).

When you have switched on the lock-off function, you will have to turn the transmitter off and on again in order to operate it.

To temporarily deactivate the lock-off function:

- ▷ Press the **SET** button.
Locked appears in the display panel.
- ▷ Press the **UP** or **DOWN** button.
Unlock? appears in the display panel.
- ▷ Press the **SET** button.
Lock-off function is now temporarily deactivated.

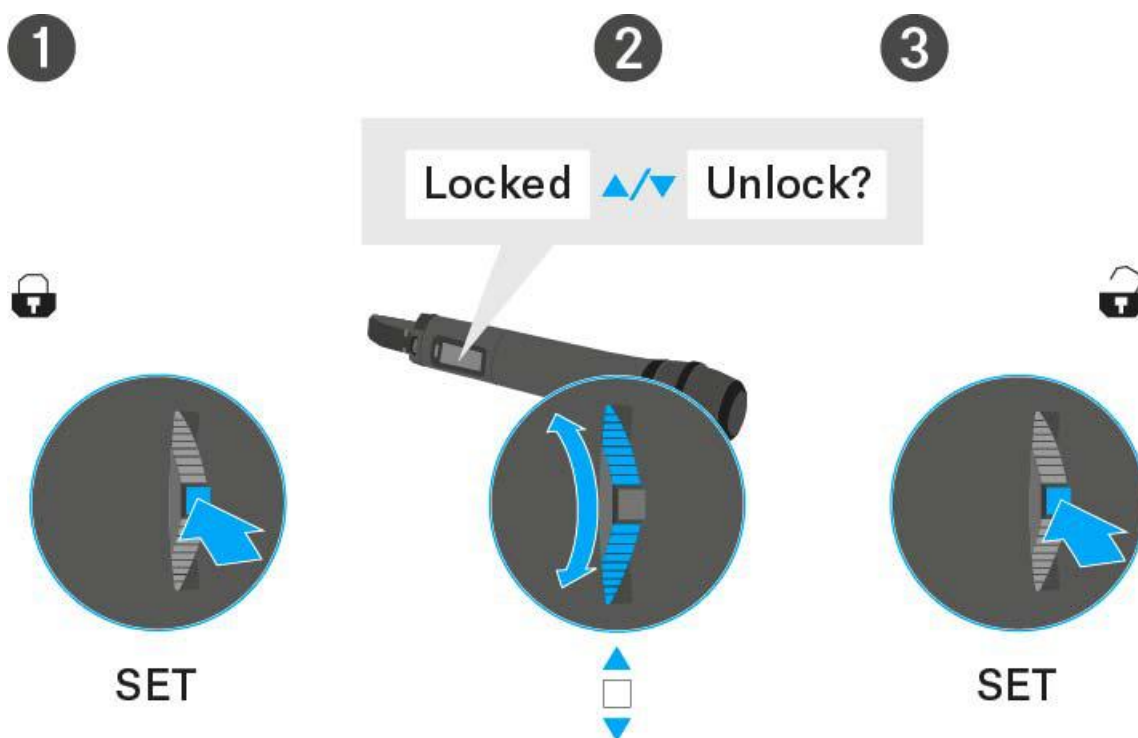



Displays on the SKM 300 G4 handheld transmitter display panel

You can view the following information on the transmitter display.

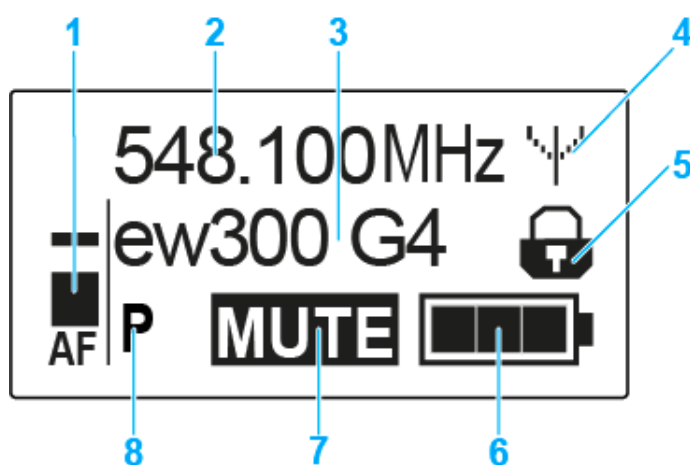

- 1 AF** audio level
 - Displays the audio level with peak hold function
 - See “Sensitivity menu item”
- 2** Frequency
 - Configured transmission frequency
 - See “Frequency Preset menu item”
- 3** Name
 - Freely selectable name of the receiver
 - See “Name menu item”
- 4** Transmission icon
 - RF signal is being transmitted
 - See “Deactivating the RF signal (RF mute)”
- 5** Lock-off function
 - Lock-off function is activated
 - See “Auto Lock menu item”
- 6** Battery status
 - See “Battery status”
- 7 MUTE** muting function
 - The audio signal is muted
 - See “Muting the handheld transmitter (AF mute)”
- 8 P** pilot tone
 - Pilot tone transmission is activated
 - See “Advanced > Pilot Tone menu item”

>> “Buttons for navigating the SKM 300 G4 menu”

>> “Setting options in the menu”



Select a standard display

- ▷ Move the **multi-function switch** to select a standard display:

Frequency/Name standard display



Channel/Frequency standard display



Name/Channel standard display





Buttons for navigating the SKM 300 G4 menu

Navigating through the menu

To open the menu:

- ▷ Press the **SET** button.
The operating menu is shown on the transmitter display panel.

To open a menu item:

- ▷ Press the **UP** or **DOWN** buttons to navigate through the individual menu items.
- ▷ Press the **SET** button to open the selected menu item.

 “Operating elements of the SKM 300 G4 handheld transmitter”

Making changes in a menu item

After you open a menu item, you can make changes as follows:

- ▷ Press the **UP** or **DOWN** buttons to set the displayed value.
- ▷ Press the **SET** button to save the setting.
- ▷ Press the **ESC (ON/OFF)** button to leave the menu item without saving the setting.

 “Operating elements of the SKM 300 G4 handheld transmitter”

>> “Displays on the SKM 300 G4 handheld transmitter display panel”

>> “Setting options in the menu”



Sensitivity menu item

- Adjusting the input sensitivity – **AF** audio level

Setting range: 0 dB to -48 dB in 6 dB steps

The **AF** audio level is also displayed when the wireless microphone is muted, e.g. to check the sensitivity before a live broadcast.

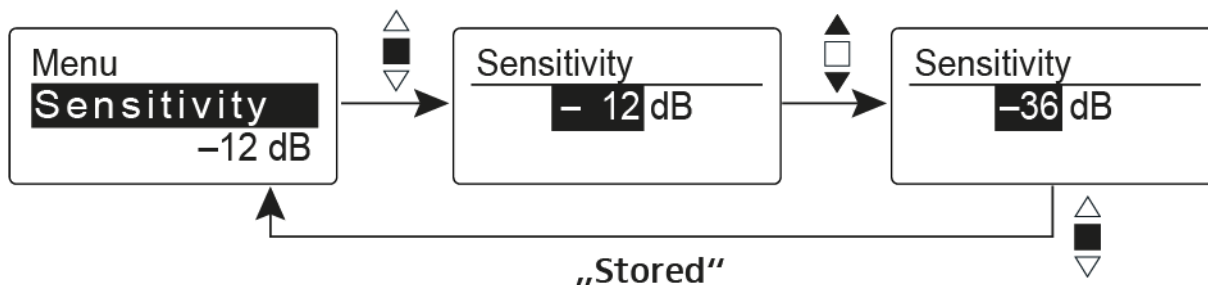

Recommended presets:

- Loud music/vocals: -48 to -18 dB
- Moderation: -18 to -12 dB
- Interviews: -12 to 0 dB

Frequency Preset menu item

- Manually selecting a frequency bank and channel

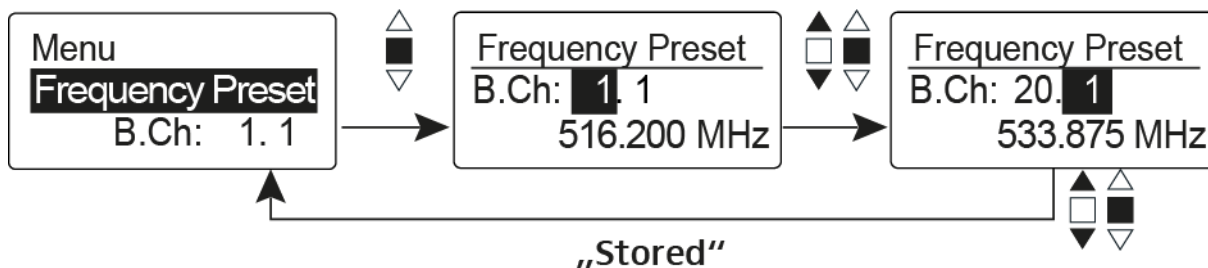

i While you work in the **Frequency Preset** menu, the RF signal is deactivated.

Please note when creating multi-channel systems:

Only the factory-preset frequencies within one frequency bank are intermodulation-free. The wireless microphone and receiver must be set to the same frequency. Be sure to note the information on frequency selection under “Establishing a radio link”.



Name menu item

- Entering names

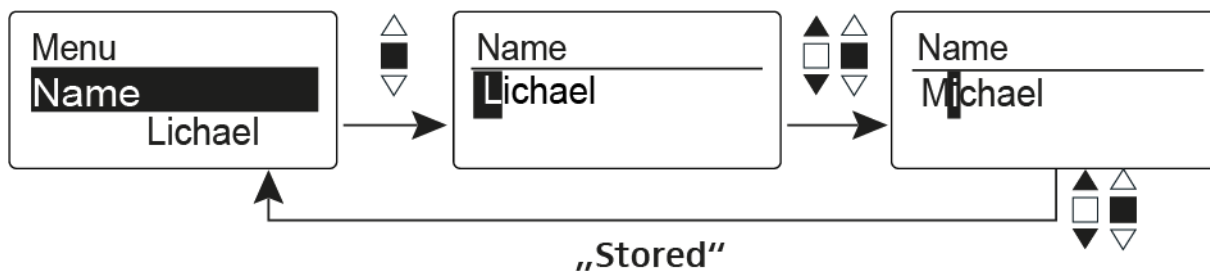

In the **Name** menu item you can enter any name you want for the wireless microphone (e.g. the names of the musicians).

The name can be shown in the [Frequency/Name](#) and [Name/Channel](#) standard displays.

The names are a maximum of 8 characters:

- All letters except umlauts.
- Numbers from 0 to 9
- Special characters and spaces

Enter the names as follows:

- ▷ Move the multi-function switch to select a character.
- ▷ Press the multi-function switch to jump to the next space or to save the name you have entered once it is complete.

Auto Lock menu item

- Switching the automatic lock-off function on and off

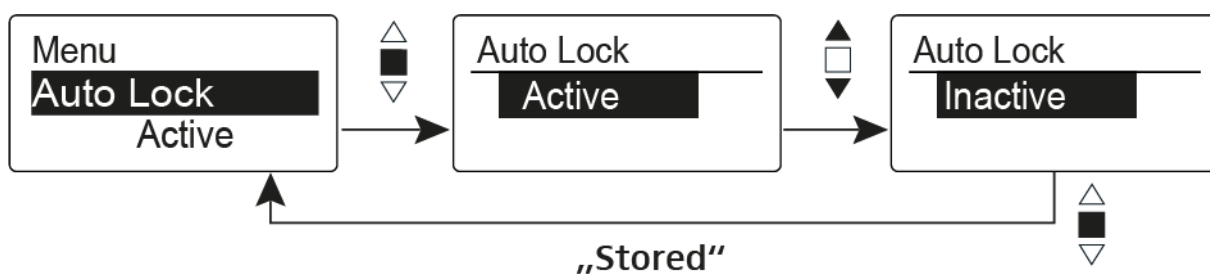

This lock prevents the wireless microphone from being unintentionally switched off and also prevents any unintentional changes to the transmitter's configuration. In the current standard display, the lock icon shows whether the lock-off function is currently switched on.

You can find information about using the lock-off function under "Lock-off function".



Advanced > Tune menu item

- Configuring the transmission frequency and frequency bank U

When you have configured the wireless microphone to a system bank and you call up the **Tune** menu item, channel 1 of the frequency bank **U** is automatically set. The message **U.1** briefly appears in the display. In the factory settings, the channels of the frequency bank **U** are not assigned to any transmission frequency.

While you work in the **Tune** menu, the RF signal is deactivated.

You can configure a transmission frequency for the current channel or select a channel in the frequency bank **U** and configure a transmission frequency for this channel in the **Tune** menu. Be sure to note the information on frequency selection, see “Setting notes”.

Only adjusting the frequency

To configure the transmission frequency for the current channel:

- ▷ Move the multi-function switch until the **Tune** menu item appears.
- ▷ Press the multi-function switch.

The frequency selection appears.

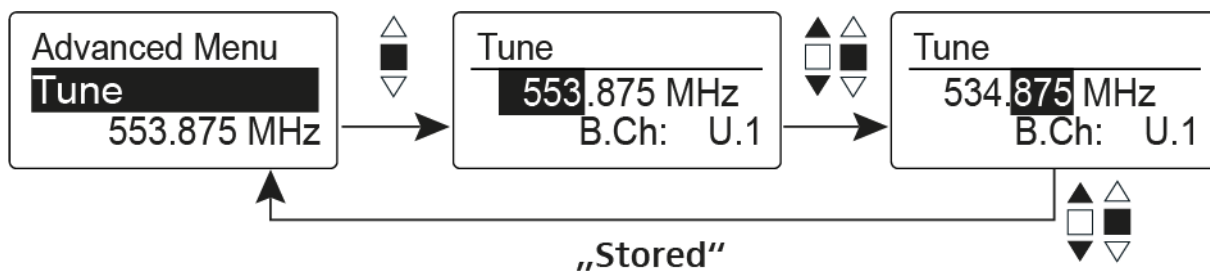

- ▷ Configure the desired frequency.
 - ▷ Press the multi-function switch.
- Your settings will be saved. You are now back in the operating menu.

Setting the channel and frequency

To select a **channel** and assign it a frequency:

- ▷ Move the multi-function switch until the **Tune** menu item appears.
- ▷ Hold down the multi-function switch until the frequency bank selection appears.

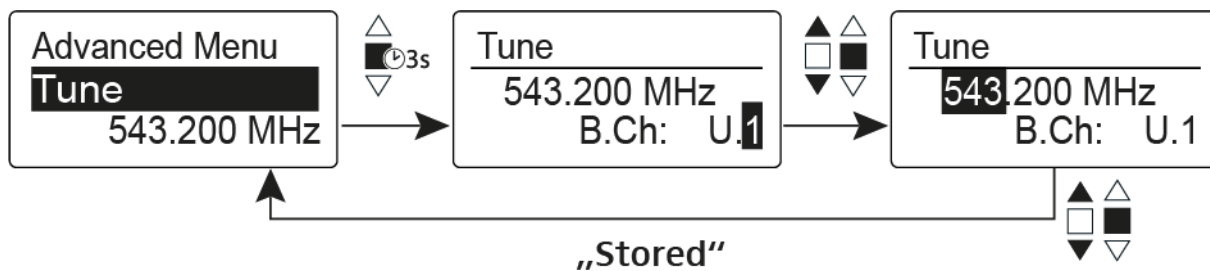

- ▷ Set the desired channel.
 - ▷ Press the multi-function switch.
- The frequency selection appears.
- ▷ Configure the frequency.



Advanced > Mute Mode menu item

- Configuring the function of the **MIC** button

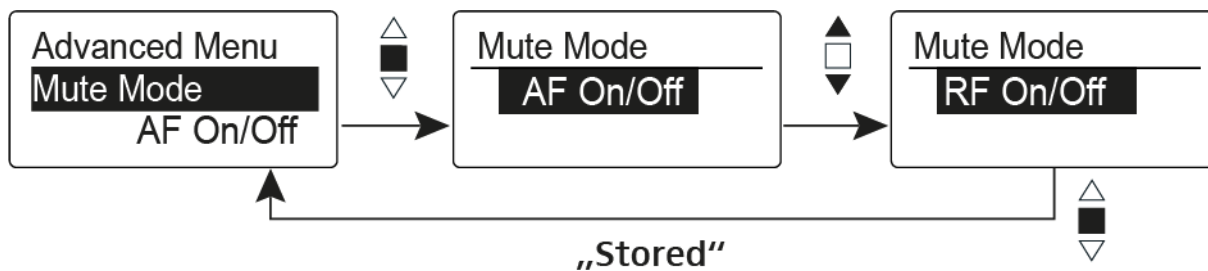

AF On/Off mode

- When you press the **MIC** button, no audio signal is transmitted.

RF On/Off mode

- When you press the **MIC** button, the RF signal is deactivated.

Push To Mute mode

- The audio signal is deactivated as long as you press down the **MIC** button.

Push To Talk mode

- The audio signal is activated as long as you press down the **MIC** button.
- The wireless microphone is muted when you configure the **Push to Talk** function.

Disabled mode

- No function

You can find information about the **MIC** button under “Muting the handheld transmitter (AF mute)” and “Deactivating the RF signal (RF mute)”.



Advanced > MIC LED menu item

- Configuring the background lighting of the MIC button

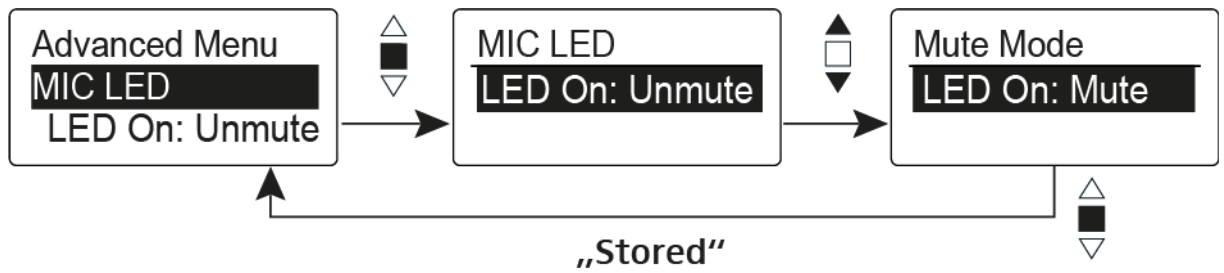

In the **MIC LED** menu item you can configure and deactivate the background lighting of the **MIC** button regardless of the settings of the “Advanced > Mute Mode menu item” and the status of the RF signal.

LED On: [setting Unmute](#)

- The **MIC** button is backlit when the wireless microphone sends an RF signal or is not muted.

LED On: [setting Mute](#)

- The **MIC** button is backlit when the wireless microphone is not sending an RF signal or is muted.

Disable LED [setting](#)

- The background lighting of the **MIC** button is deactivated.



Advanced > RF Power menu item

- Configuring the transmission power

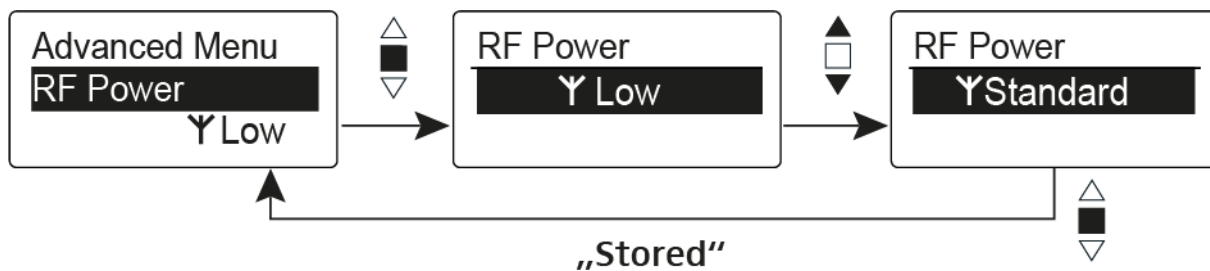

You can configure the transmission power in three steps in the **RF Power** menu item. Please note the information at the following address:

General conditions and restrictions for the use of frequencies

Setting range:

Low: 10 mW

Standard: 30 mW

High: 50 mW

Advanced > Pilot Tone menu item

- Activating/deactivating pilot tone transmission

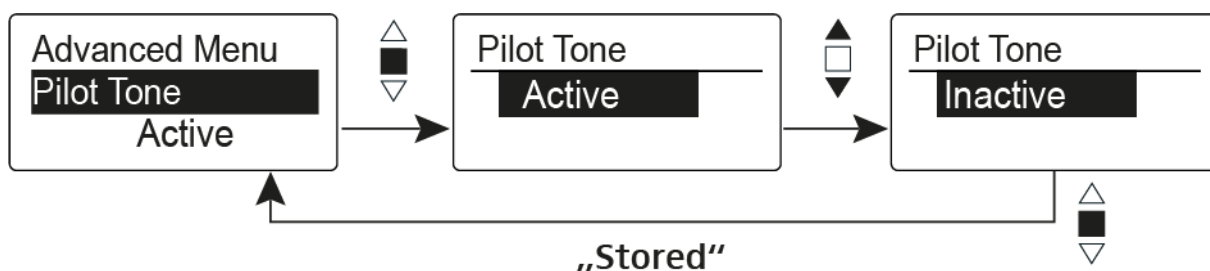

The pilot tone has an inaudible frequency that is sent from the transmitter and evaluated by the receiver. It supports the receiver's squelch function.

Advanced > LCD Contrast menu item

- Adjusting the contrast of the display panel

You can configure the contrast of the display in 16 steps.



Advanced > Reset menu item

- Resetting the wireless microphone

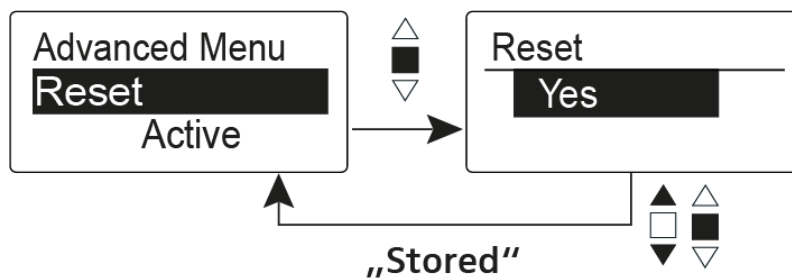

When you reset the wireless microphone, only the selected settings of the pilot tone and the **U1** to **U6** frequency banks are retained.

Advanced > Software Revision menu item

- Show software revision

You can display the current software revision.



Establishing a radio link

To establish a radio link between the transmitter and receiver, the same frequency must be set in both devices.

You can do this in a number of different ways:

1. Use the **Easy Setup** function to perform an **automatic frequency set-up** (see “Easy Setup menu item”).
2. Set a frequency in the receiver **manually** (see “Frequency Preset menu item”) and **synchronize** it with the transmitter (see “Synchronizing devices”).
3. Set the frequency on the receiver and the transmitter **manually** (EM 300–500 G4: “Frequency Preset menu item”, SKM 300 G4: “Frequency Preset menu item”, SK 300 G4: “Frequency Preset menu item”, SKM 500 G4: “Frequency Preset menu item”, SK 500 G4: “Frequency Preset menu item”).

Setting notes

Please note the following when synchronizing a transmitter with a receiver:

- ▷ Only use transmitters and receivers from the same frequency range (see the type plate on the transmitter and receiver).
- ▷ Make sure that your chosen frequencies are listed in the frequency table for the particular frequency range (see “Frequency tables”).
- ▷ Ensure that the desired frequencies are permitted in your country and apply for an operating license if necessary.



Please note the information at the following address:

General conditions and restrictions for the use of frequencies



Synchronizing devices

You can synchronize ew 300-500 G4 series transmitters and receivers via the receiver's infrared interface.

You can adjust the **Parameters** to be transferred to the transmitter here: "Advanced -> Sync Settings menu item".

To synchronize the devices:

- ▷ Switch the transmitter and the receiver on.
- ▷ Press the **SYNC** button on the receiver.
 - Sync** appears in the receiver's display and the blue LED turns blue.



- ▷ Hold the infra-red interface of the transmitter in front of the infra-red interface of the receiver.





The parameters are transferred to the transmitter. The blue LED blinks during transmission.

When the transfer is complete, a tick appears in the receiver's display as a confirmation. Then the receiver will return to the current standard display.

To cancel synchronization:

▷ Press the **ESC** button on the receiver.

An **X** appears in the display.

This icon also appears when:

- no transmitter is found or the transmitter is not compatible.
- no transmitter is found and the synchronization process automatically ends after 30 seconds.



Product variants

EM 300-500 G4 product variants

Made in Germany

EM 300-500 G4-K+	925 – 937.5 MHz	Art. no. 507790
EM 300-500 G4-GBw	606 – 678 MHz	Art. no. 507791
EM 300-500 G4-Gw	558 – 626 MHz	Art. no. 507792
EM 300-500 G4-Bw	626 – 698 MHz	Art. no. 507793
EM 300-500 G4-Cw	718 – 790 MHz	Art. no. 507794
EM 300-500 G4-Dw	790 – 865 MHz	Art. no. 507795
EM 300-500 G4-Aw+	470 – 558 MHz	Art. no. 508415

Assembled in the USA

EM 300-500 G4-AS	520 – 558 MHz	Art. no. 508129
EM 300-500 G4-JB	806 – 810 MHz	Art. no. 508130
EM 300-500 G4-Gw	558 – 626 MHz	Art. no. 508131
EM 300-500 G4-Bw	626 – 698 MHz	Art. no. 508132
EM 300-500 G4-Cw	718 – 790 MHz	Art. no. 508133
EM 300-500 G4-Dw	790 – 865 MHz	Art. no. 508134
EM 300-500 G4-Aw+	470 – 558 MHz	Art. no. 508135
EM 300-500 G4-Gw1	558 – 608 MHz	Art. no. 508457



SKM 300 G4 product variants

Made in Germany

SKM 300 G4-S-K+	925 – 937.5 MHz	Art. no. 507727
SKM 300 G4-S-GBw	606 – 678 MHz	Art. no. 507728
SKM 300 G4-S-Gw	558 – 626 MHz	Art. no. 507729
SKM 300 G4-S-Bw	626 – 698 MHz	Art. no. 507730
SKM 300 G4-S-Cw	718 – 790 MHz	Art. no. 507731
SKM 300 G4-S-Dw	790 – 865 MHz	Art. no. 507732
SKM 300 G4-S-Aw+	470 – 558 MHz	Art. no. 508407

Assembled in the USA

SKM 300 G4-S-AS	520 – 558 MHz	Art. no. 508067
SKM 300 G4-S-JB	806 – 810 MHz	Art. no. 508068
SKM 300 G4-S-Gw	558 – 626 MHz	Art. no. 508069
SKM 300 G4-S-Bw	626 – 698 MHz	Art. no. 508070
SKM 300 G4-S-Cw	718 – 790 MHz	Art. no. 508071
SKM 300 G4-S-Dw	790 – 865 MHz	Art. no. 508072
SKM 300 G4-S-Aw+	470 – 558 MHz	Art. no. 508428
SKM 300 G4-S-Gw1	558 – 608 MHz	Art. no. 508449



EM 300-500 G4

RF characteristics

Modulation	Wideband FM
Receiving frequency ranges	Aw+: 470 – 558 MHz AS: 520 – 558 MHz Gw1: 558 – 608 MHz Gw: 558 – 626 MHz GBw: 606 – 678 MHz Bw: 526 – 698 MHz Cw: 718 – 790 MHz Dw: 790 – 865 MHz JB: 806 – 810 MHz K+: 925 – 937.5 MHz
Receiving frequencies	Max 2880 receiving frequencies, adjustable in 25 kHz steps 20 frequency banks, each with up to 32 factory-preset channels, no intermodulation 6 frequency banks with up to 32 programmable channels
Switching bandwidth	up to 88 MHz
Nominal/peak deviation	±24 kHz / ±48 kHz
Receiver principle	True diversity
Sensitivity (with HDX, peak deviation)	< 2.5 µV for 52 dBA _{eff S/N}
Adjacent channel selection	Typically ≥ 75 dB
Intermodulation attenuation	Typically ≥ 70 dB
Blocking	≥ 75 dB
Squelch	5 to 25 dBµV, can be set in 2 dB steps
Pilot tone squelch	Can be switched off
Antenna inputs	2 BNC sockets



AF characteristics

Compander system	Sennheiser HDX
EQ presets (switchable, act on line and monitor outputs):	
Preset 1: Flat	
Preset 2: Low Cut	-3 dB at 180 Hz
Preset 3: Low Cut / High Boost	-3 dB at 180 Hz +6 dB at 10 kHz
Preset 4: High Boost	+6 dB at 10 kHz
Signal-to-noise ratio (1 mV, peak deviation)	≥ 115 dBA
Total harmonic distortion (THD)	≤ 0.9 %
AF output voltage (at peak deviation, 1 kHz AF)	6.3 mm jack socket (unbalanced): +12 dBu BNC socket (balanced): +18 dBu
AF OUT setting range	48 dB in 3 dB steps

Overall device

Temperature range	-10 °C to +55 °C (14 °F to 131 °F)
Power supply	12 V DC
Power consumption	300 mA
Dimensions	Approx. 202 x 212 x 43 mm
Weight	approx. 980 g



SKM 300 G4

RF characteristics

Modulation	Wideband FM
Receiving frequency ranges	Aw+: 470 – 558 MHz AS: 520 – 558 MHz Gw1: 558 – 608 MHz Gw: 558 – 626 MHz GBw: 606 – 678 MHz Bw: 526 – 698 MHz Cw: 718 – 790 MHz Dw: 790 – 865 MHz JB: 806 – 810 MHz K+: 925 – 937.5 MHz
Transmission frequencies	Max 2880 receiving frequencies, adjustable in 25 kHz steps 20 frequency banks, each with up to 32 factory-preset channels, no intermodulation 6 frequency banks with up to 32 programmable channels
Switching bandwidth	up to 88 MHz
Nominal/peak deviation	±24 kHz / ±48 kHz
Frequency stability	≤ ±15 ppm
RF output power at 50 ?	Switchable: Low: typically 10 mW Standard: typically 30 mW High: typically 50 mW
Pilot tone squelch	Can be switched off



AF characteristics

Compander system	Sennheiser HDX
AF frequency response	80 – 18,000 Hz
Signal-to-noise ratio (1 mV, peak deviation)	≥ 115 dBA
Total harmonic distortion (THD)	≤ 0.9 %
Setting range for input sensitivity	48 dB in 6 dB steps

Overall device

Temperature range	-10 °C to +55 °C (14 °F to 131 °F)
Power supply	2 AA batteries, 1,5 V or BA 2015 accupack
Nominal voltage	3 V battery / 2.4 V rechargeable battery
Power consumption	
at nominal voltage with transmitter switched off	typically 180 mA ≤ 25 µA
Operating time	Typically 8 h
Dimensions	Approx. Ø 50 x 265 mm
Weight (with batteries)	Approx. 450 g



6.3 mm mono jack plug, unbalanced

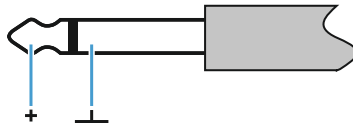

- Connect to:
 - EM 100 G4 Audio Out
 - EM 300-500 G4 Audio Out

6.3 mm stereo jack plug for headphone jack

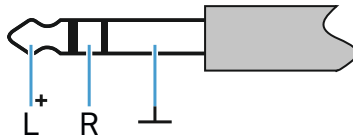

- Connect to:
 - EM 100 G4 headphone input
 - EM 300-500 G4 headphone input
 - SR IEM G4 headphone input

XLR-3 plug, balanced

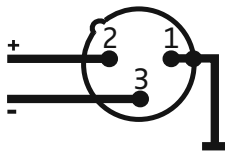

Hollow jack plug for power supply





Cleaning and maintenance

Note the following information when cleaning and maintaining evolution wireless G4 series products.

CAUTION

Liquids can damage the products' electronics.

Liquids entering the product housing can cause a short-circuit and damage the electronics.

- ▷ Keep all liquids away from the products.
- ▷ Do not use any solvents or cleansing agents.

-
- ▷ Disconnect the products from the power supply system and remove rechargeable batteries and batteries before you begin cleaning.
 - ▷ Clean all products only with a soft, dry cloth.

- ▷ Note the special cleaning instructions below for the following products.

Cleaning the sound inlet basket of the microphone module

- ▷ Unscrew the top sound inlet basket from the microphone module by turning it counterclockwise.
- ▷ Remove the foam insert.

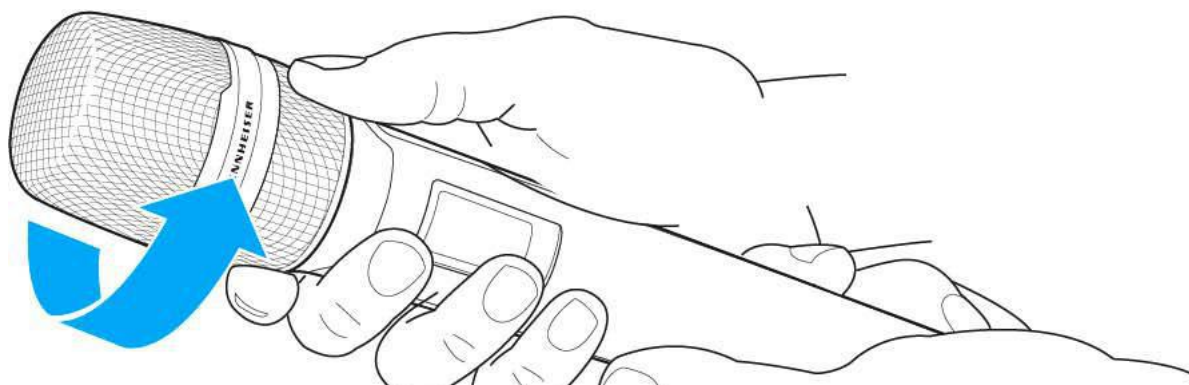

You can clean the sound inlet basket in two ways:

- ▷ Use a slightly damp cloth to clean the top sound inlet basket from the inside and outside.
- ▷ Use a brush and rinse with clean water.
- ▷ If necessary, clean the foam insert with a mild detergent or replace the foam insert.
- ▷ Dry the top sound inlet basket and foam insert.
- ▷ Reinsert the foam insert.



- ▷ Screw the sound inlet basket back onto the microphone module.

From time to time, you should also clean the microphone module contacts:

- ▷ Wipe the contacts of the microphone module with a soft, dry cloth.



CONTACT

Contact

Instruction manual as a PDF

You can find this instruction manual as a PDF (German and English) in the download section of the Sennheiser website at **www.sennheiser.com/download**.

Download area for the Sennheiser website

- ▷ Enter **ew G4** into the search bar to show the instruction manuals for products in the ew G4 series.

Customer service

If you have technical questions or experience problems with the product, you can access Sennheiser customer service at **www.sennheiser.com/service-support**.

Sennheiser customer service online area

Feedback

Do you have any questions or suggestions about this instruction manual? Write to us at **techcomm@sennheiser.com**.



Sennheiser electronic GmbH & Co. KG

Am Labor 1, 30900 Wedemark, Germany
www.sennheiser.com