

eW 300 IEM G2 SR 350 IEM G2

Instructions for use

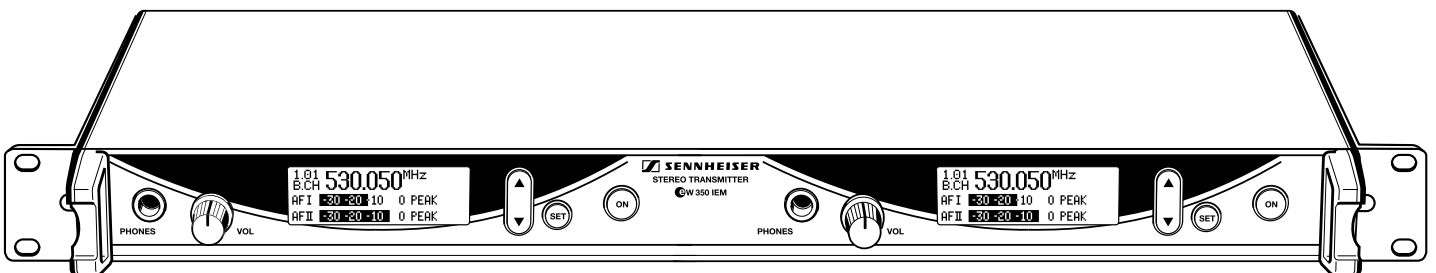
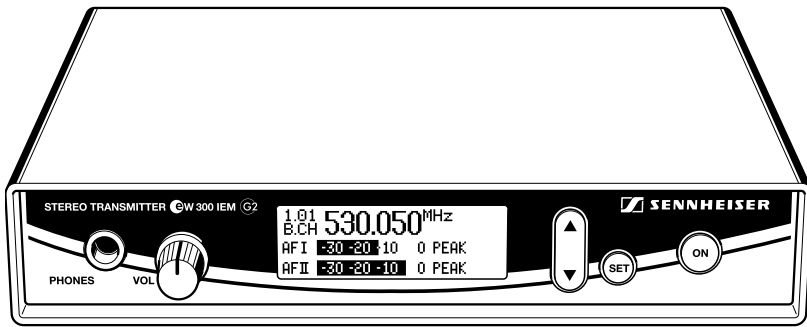
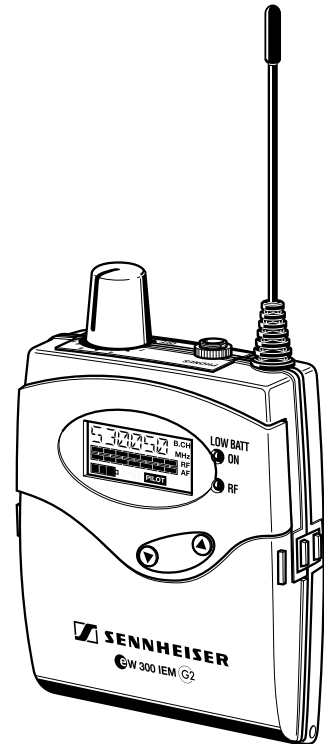
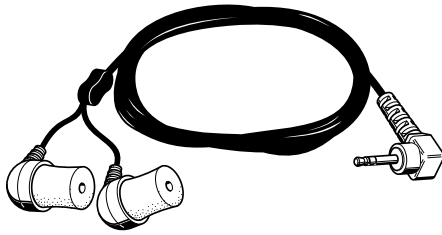

Contents

Important safety instructions	2
The ew 300 IEM G2 systems	4
The channel bank system	5
Delivery includes	5
Overview of operating controls	6
Stereo transmitter – front view (SR 350 IEM G2 twin transmitter)	6
Stereo transmitter – rear view	7
EK 300 IEM G2 stereo receiver	8
Indications and displays on the transmitter	9
Indications and displays on the receiver	9
Preparing the devices for use	11
SR 300 IEM G2 transmitter/ SR 350 IEM G2 twin transmitter	11
Changing the transmission power (SR 350 IEM G2 only)	15
EK 300 IEM G2 receiver	17
Using the components	18
Switching the components on/off	18
Adjusting the volume	19
Adjusting the balance	19
Activating/deactivating the lock mode	19
Attaching the receiver to clothing	19
The operating menu	20
The buttons	20
Overview of menus	21
Working with the operating menu	21
Operating menu of the stereo transmitter	23
Operating menu of the stereo receiver	25
Adjustment tips for the operating menu	28
Switching between channel banks	28
Switching between the channels in a channel bank	28
Selecting the frequencies to be stored in the channel bank "U"	28
Scanning the channel banks for free channels (receiver only)	28
Multi-channel operation	29
Adjusting the squelch threshold (receiver only)	29
Stereo/FOCUS selection (receiver only)	30
Limiting the volume at the headphone output (receiver only)	30
Activating/deactivating the frequency boost (receiver only)	30
Adjusting the sensitivity (transmitter only)	30
Selecting the standard display	31
Entering names	32
Loading the factory-preset default settings	32
Activating/deactivating the pilot tone evaluation (receiver only)	32
Adjusting the contrast of the graphic display (transmitter only)	32
Stereo/mono selection (transmitter only)	33
Activating/deactivating the lock mode	33
Exiting the operating menu	33
If a problem occurs	34
Error checklist	34
Recommendations and tips	35
Care and maintenance	35
Additional information	36
HDX noise reduction	36
Wireless transmission systems	36
Squelch	37
Specifications	38
Connector assignment	39
Accessories and spare parts	40
Manufacturer Declarations	41
Thank you for choosing Sennheiser!	

We have designed this product to give you reliable operation over many years. Over 60 years of accumulated expertise in the design and manufacture of high-quality electro-acoustic equipment have made Sennheiser a world-leading company in this field.

Please take a few moments to read these instructions carefully, as we want you to enjoy your new Sennheiser products quickly and to the fullest.

Important safety instructions

1. Read these instructions.
2. Keep these instructions. Always include these instructions when passing the devices on to third parties.
3. Heed all warnings.
4. Follow all instructions.
5. Do not use the devices near water.
6. Clean only with a dry cloth.
7. Do not block any ventilation openings. Install in accordance with these instructions.
8. Do not install near any heat sources such as radiators, heat registers, stoves, or other devices (including amplifiers) that produce heat.
9. The devices should be operated only from the type of power source indicated on the mains plug. The devices must only be connected to properly grounded power outlets.
10. Protect the mains cable from being walked on or pinched, particularly at plugs, convenience receptacles, and the point where they exit from the device.
11. Only use attachments/accessories specified by Sennheiser.
12. Use only with the cart, stand, tripod, bracket, or table specified by the manufacturer, or sold with the device. When a cart is used, use caution when moving the cart/apparatus combination to avoid injury from tip-over.
13. Unplug the devices during lightning storms or when unused for long periods of time.
14. Refer all servicing to qualified service personnel.
Servicing is required if the device has been damaged in any way, such as mains cable or plug damage, liquid has been spilled, objects have fallen inside, the device has been exposed to rain or moisture, does not operate properly or has been dropped.
15. To completely disconnect the devices from the AC mains, disconnect the mains plug from the AC receptacle.
16. **WARNING:** To reduce the risk of fire or electric shock, do not expose the devices to rain or moisture.
17. Do not expose the devices to dripping or splashing and ensure that no objects filled with liquids, such as vases or coffee cups, are placed on the devices.
18. The plug of the mains cable shall remain readily operable and easily accessible.



Hazard warnings on the rear of the transmitter (SR 350 IEM G2 only)

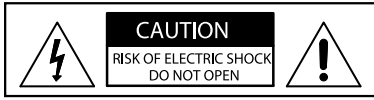

The label shown on the left is attached to the rear of the transmitter. The symbols on this label have the following meaning:



This symbol is intended to alert the user to the presence of uninsulated dangerous voltage within the transmitter's enclosure that may be of sufficient magnitude to constitute risk of fire or electric shock.



This symbol is intended to alert the user to the risk of electric shock if the transmitter is opened. There are no user serviceable parts inside. Refer servicing to qualified personnel only.



This symbol is intended to alert the user to the presence of important operating and maintenance instructions in the literature accompanying this transmitter.

Overloading

Do not overload wall outlets and extension cables as this may result in fire and electric shock.

Replacement parts

When replacement parts are required, be sure the service technician has used replacement parts specified by Sennheiser or those having the same characteristics as the original part. Unauthorized substitutions may result in fire, electric shock, or other hazards.

Safety check

Upon completion of any service or repairs to this device, ask the service technician to perform safety checks to determine that the device is in safe operating order.

Danger due to high volumes

This is a professional transmission system. Commercial use is subject to the rules and regulations of the trade association responsible. Sennheiser, as the manufacturer, is therefore obliged to expressly point out possible health risks arising from use.

This system is capable of producing sound pressure exceeding 85 dB(A). 85 dB(A) is the sound pressure corresponding to the maximum permissible volume which is by law (in some countries) allowed to affect your hearing for the duration of a working day. It is used as a basis according to the specifications of industrial medicine. Higher volumes or longer durations can damage your hearing. At higher volumes, the duration must be shortened in order to prevent hearing damage. The following are sure signs that you have been subjected to excessive noise for too long a time:

- You can hear ringing or whistling sounds in your ears.
- You have the impression (even for a short time only) that you can no longer hear high notes.

Reception interference due to high transmission power

The SR 350 IEM G2 twin transmitter can be switched to a transmission power of 100 mW. Depending on the selected frequency, this can affect the reception of other wireless systems.

Intended use of the devices

Intended use of the ew 300 IEM G2 series devices includes:

- using the devices for professional purposes,
- having read these instructions especially the chapter “Important safety instructions” on page 2,
- using the devices within the operating conditions and limitations described in this instruction manual.

“Improper use” means using the devices other than as described in these instructions, or under operating conditions which differ from those described herein.

The ew 300 IEM G2 systems

With the Sennheiser evolution wireless in-ear monitoring systems ew 300 IEM G2 (suitable for both stage and broadcast use), musicians, video and sound amateurs, reporters/broadcasters, etc. can directly monitor the received sound signals without troublesome cables or monitor speakers being required. In addition, the system can also be used for any application where talkback signals are to be transmitted.

The evolution wireless in-ear monitoring systems ew 300 IEM G2 are high-quality state-of-the-art RF transmission systems with a high level of operational reliability and ease of use. The transmitters and the receiver permit wireless transmission with studio-quality sound. The excellent transmission reliability of the ew 300 IEM G2 systems is based on the use of

- further optimized PLL synthesizer and microprocessor technology,
- the **HDX** noise reduction system,
- the pilot tone squelch control (during stereo operation),
- and the scan function for scanning the channel banks for free channels.

The ew 300 IEM series offers two systems:

- the ew 300 IEM G2 system
(SR 300 IEM G2 stereo transmitter, EK 300 IEM G2 stereo receiver)
- and the SR 350 IEM G2 twin transmitter

The EK 300 IEM G2 can also be used with the SR 350 IEM G2 twin transmitter. The SR 350 IEM G2 twin transmitter consists of two complete SR 300 IEM G2 stereo transmitters, but offers some advantages such as

- easy rack mounting,
- a built-in mains unit
- and a switchable transmission power for optimum operational reliability under varying transmission conditions.

The channel bank system

The ew 300 IEM G2 systems are available in six UHF frequency ranges with 1440 transmission/receiving frequencies per frequency range. Please note: Frequency usage is different for each country. Your Sennheiser agent will have all the necessary details on the available legal frequencies for your area:

Range A: 518 to 554 MHz Range D: 786 to 822 MHz
 Range B: 626 to 662 MHz Range E: 830 to 866 MHz
 Range C: 740 to 776 MHz Range G: 572 to 608 MHz

The transmitters and the receiver of the ew 300 IEM G2 systems have nine channel banks with up to 12 switchable channels each.

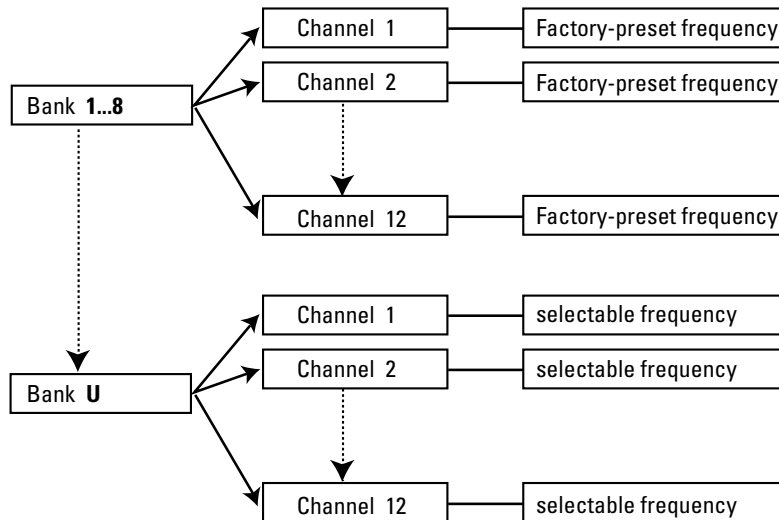

The channel banks "1" to "8" have up to 12 switchable channels that are factory-preset to a transmission/receiving frequency (see enclosed frequency table). These transmission/receiving frequencies cannot be changed but have been preset so that e.g. country-specific regulations on frequency usage are taken into account (see "Type approvals" on page 39). For detailed information, please refer to the enclosed frequency data sheets and to the country-specific frequency and transmission power overviews.

An advantage of the factory-preset frequencies is that

- the system is ready for immediate use after switch-on,
- several transmission systems can be operated simultaneously on the preset channels without causing intermodulation interference.

Delivery includes

Depending on the purchased system, delivery includes:

ew 300 IEM G2 system	SR 350 IEM G2
<ul style="list-style-type: none"> • 1 EK 300 IEM G2 stereo receiver • 1 SR 300 IEM G2 stereo transmitter • 2 batteries • 1 telescopic antenna for SR 300 IEM G2 • 1 NT 2-1 mains unit • 1 pair of IE 4 earphones • Instructions for use • 1 frequency data sheet • Frequency and transmission power overviews 	<ul style="list-style-type: none"> • 1 SR 350 IEM G2 stereo twin transmitter • 2 telescopic antennas for SR 350 IEM G2 • 1 mains cable • Instructions for use • 1 frequency data sheet • Frequency and transmission power overviews

Overview of operating controls

Stereo transmitter – front view (SR 350 IEM G2 twin transmitter)

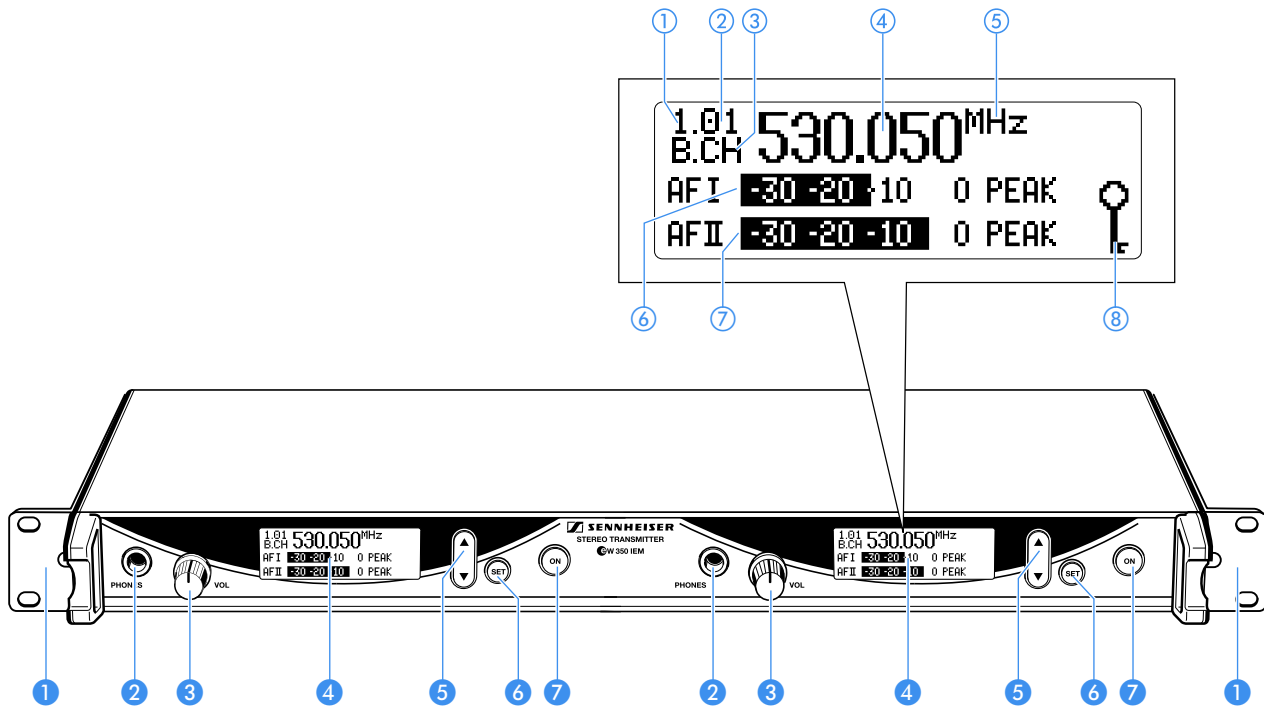

Operating controls

- ① Rack mount "ears" (preinstalled with the SR 350 IEM G2 only)
- ② Headphone output (PHONES), 1/4" (6.3 mm) jack socket
- ③ Headphone volume control (VOL)
- ④ Graphic display, backlit
- ⑤ ▼/▲ rocker button, backlit
- ⑥ SET button, backlit
- ⑦ ON button, backlit (serves as the ESC (cancel) key in the operating menu)

Graphic display panel

- ① Display for the current channel bank "1...8, U"
- ② Display for the current channel number "1 ... 12"
- ③ "B.CH" – abbreviation for channel bank and channel number
- ④ Alphanumeric display
- ⑤ "MHz" – appears when the frequency is displayed
- ⑥ Level display for audio signal "AF I" (left and MONO), with "PEAK" warning
- ⑦ Level display for audio signal "AF II" (right), with "PEAK" warning
- ⑧ Lock mode icon (lock mode is activated)

Note:

For further illustrations and examples of the different standard displays, see "Selecting the standard display" on page 31.

Stereo transmitter – rear view

Operating controls on the SR 350 IEM G2 twin transmitter

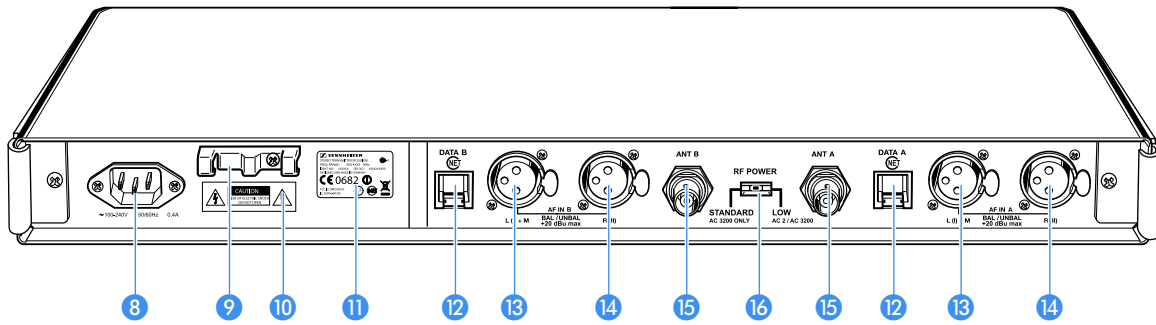

- 8 3-pin IEC mains socket
- 9 Cable grip for power supply DC cable
- 10 Label with hazard warnings
- 11 Type plate
- 12 Service interface;
connection to the NET 1 network system
- 13 Audio input (AF IN BAL/UNBAL), XLR-3F socket (left and MONO)
- 14 Audio input (AF IN BAL/UNBAL), XLR-3F socket (right)
- 15 Antenna output (ANT A/B), BNC socket
- 16 Transmission power switch (RF POWER)

Operating controls on the SR 300 IEM G2 transmitter

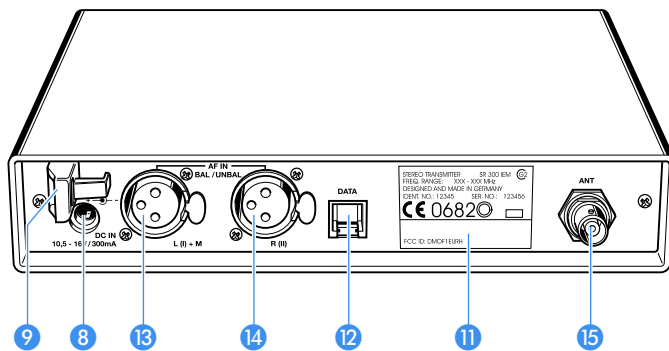

- 8 DC socket for connection of mains unit (DC IN)
- 9 Cable grip for power supply DC cable
- 11 Type plate
- 12 Service interface (DATA)
- 13 Audio input (AF IN BAL/UNBAL), XLR-3F socket (left and MONO)
- 14 Audio input (AF IN BAL/UNBAL), XLR-3F socket (right)
- 15 Antenna output (ANT), BNC socket

EK 300 IEM G2 stereo receiver

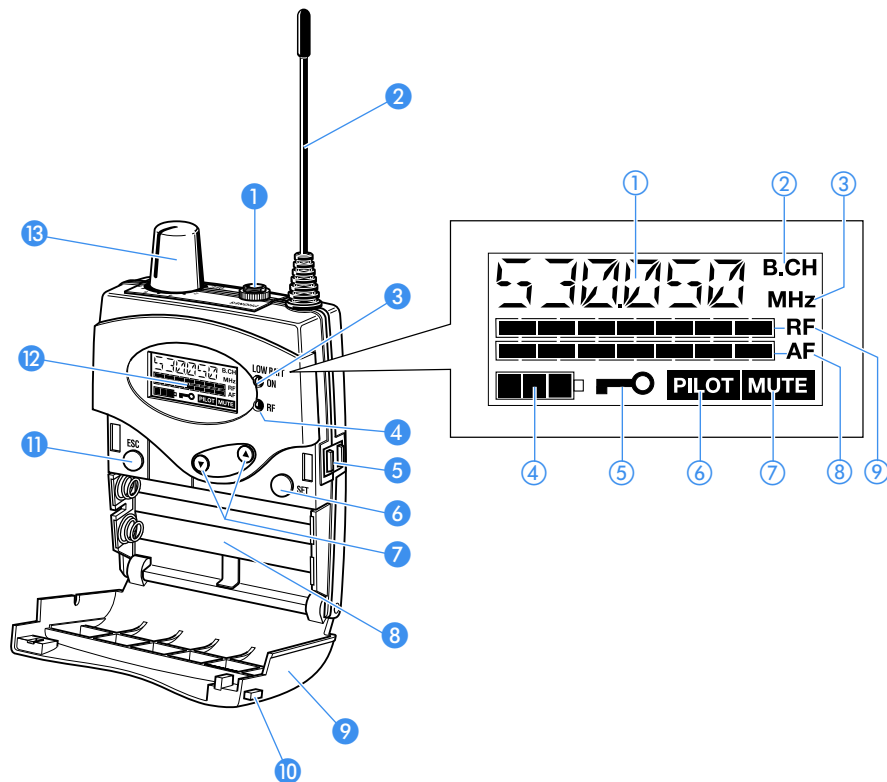

Operating controls

- ① Headphone output (PHONES), 3.5 mm jack socket
- ② Antenna
- ③ Red LED for operation and battery status indication (ON/LOW BAT)
- ④ Green LED for RF signal indication (RF)
- ⑤ Charging contacts
- ⑥ SET button
- ⑦ ▼/▲ rocker button (DOWN/UP)
- ⑧ Battery compartment
- ⑨ Battery compartment cover
- ⑩ Battery compartment release button
- ⑪ ESC button
- ⑫ LC display
- ⑬ On/off/volume control

LC display panel

- ① Alphanumeric display
- ② "B.CH" – appears when the channel bank and the channel number are displayed
- ③ "MHz" – appears when the frequency is displayed
- ④ 4-step battery status display
- ⑤ Lock mode icon (lock mode is activated)
- ⑥ "PILOT" display (pilot tone evaluation is activated)
- ⑦ "MUTE" display (audio output is muted)
- ⑧ 7-step level display for received audio signal "AF"
- ⑨ 7-step level display for received RF signal "RF"

Indications and displays on the transmitter

Modulation display

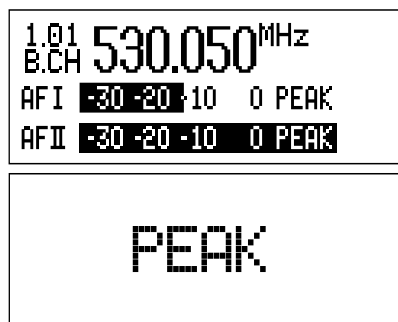

The level display for audio signal "AF" shows the modulation of the transmitter.

When the transmitter's audio input level is excessively high, the level display for audio signal "AF" shows full deflection.

When the transmitter is overmodulated frequently or for an extended period of time, the text "PEAK" (backlit in red) flashes in alternation with the standard display.

Button backlighting

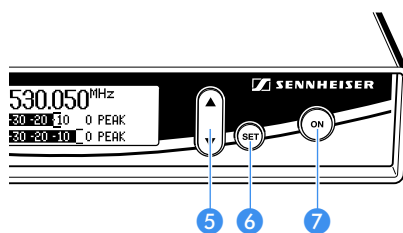

During standby operation, the ON button 7 is backlit in red. When the transmitter is switched on, the SET button 6 and the ▲/▼ button 4 are additionally backlit in green.

Indications and displays on the receiver

Operation and battery status indication

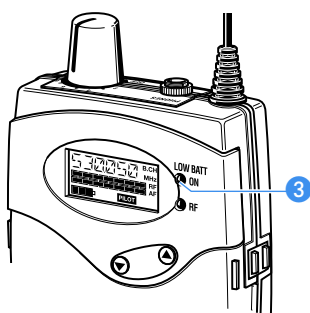

The red LED (LOW BAT/ON) 3 provides information on the current operating state of the receiver:

Red LED lit up: The receiver is switched on and the capacity of the batteries/BA 2015 accupack is sufficient.

Red LED flashing: The batteries are/the BA 2015 accupack is going flat (LOW BAT)!

In addition, the 4-step battery status display 4 on the display panel provides information on the remaining battery/BA 2015 accupack capacity:

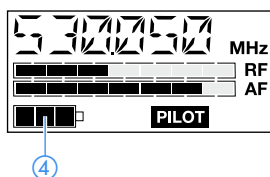

3 segments:	capacity approx. 100 %
2 segments:	capacity approx. 70 %
1 segment:	capacity approx. 30 %
Battery icon flashing:	LOW BAT

Modulation display of the received transmitter

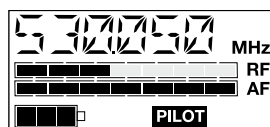

The level display for audio signal "AF" shows the modulation of the received transmitter.

When the transmitter's audio input level is excessively high (AF peak), the receiver's level display for audio signal "AF" shows full deflection.

“MUTE” display

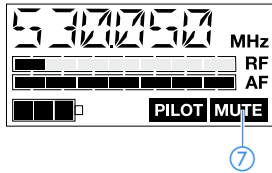

The “MUTE” display ⑦ appears on the display panel when the RF signal of the received transmitter is too weak.

“PILOT” display

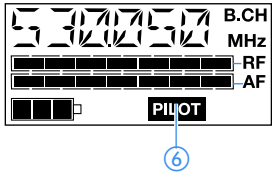

The “PILOT” display ⑥ appears on the display panel when the pilot tone evaluation is activated (see “Activating/deactivating the pilot tone evaluation (receiver only)” on page 32).

RF signal indication

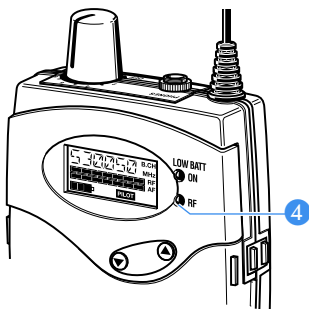

The green LED (RF) ④ at the front of the receiver lights up when an RF signal is being received.

However, the green LED (RF) does not light up when the audio output is muted because

- the RF signal of the received transmitter is too weak,
- the transmitter is set to mono operation and the receiver’s pilot tone evaluation is deactivated.

Display backlighting

After pressing a button, the display remains backlit for approx. 15 seconds.

Preparing the devices for use

SR 300 IEM G2 transmitter/ SR 350 IEM G2 twin transmitter

Fitting the device feet

To ensure that the transmitter cannot slip on the surface on which it is placed, four self-adhesive soft rubber feet are supplied.

Note:

Do not fit the rubber feet when rack mounting the transmitter.

CAUTION! Risk of staining of furniture surfaces!



Some furniture surfaces have been treated with varnish, polish or synthetics which might cause stains when they come into contact with other synthetics. Despite a thorough testing of the synthetics used by us, we cannot rule out the possibility of staining.

▶ Do not place the transmitter on delicate surfaces.

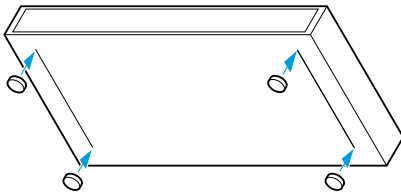

▶ Ensure that the base of the transmitter is clean and free from grease before mounting the rubber feet.

▶ Fix the rubber feet to the base of the transmitter by peeling off the safety paper and fitting them as shown in the diagram on the left.

Rack mounting

CAUTION! Risks when rack mounting the transmitter!



When installing the device in a closed or multi-rack assembly, please consider that, during operation, the ambient temperature within the rack may significantly rise above room temperature.

▶ The ambient temperature within the rack must not exceed the temperature limit specified in the specifications.

▶ When installing the device in a rack, take good care not to affect the ventilation required for safe operation or provide additional ventilation.

▶ Make sure the mechanical loading of the rack is even to avoid a hazardous condition such as a severely unbalanced rack.

▶ When connecting the device to the power supply, observe the information indicated on the type plate. Avoid circuit overloading. If necessary, provide overcurrent protection.

▶ Ensure a reliable mains ground connection of the device by taking appropriate measures.

▶ When installing the device in a closed or multi-rack assembly, please note that intrinsically harmless leakage currents of the individual devices may accumulate, thereby exceeding the allowable limit value. As a remedy, ground the rack via an additional ground connection.

Rack mounting the SR 350 IEM G2 twin transmitter

The rack mount "ears" are already fitted to the twin transmitter on delivery. To mount the twin transmitter into a 19" rack:

- ▶ Slide the twin receiver into the 19" rack.
- ▶ Secure the rack mount "ears" to the rack using four screws (not included).

Rack mounting the SR 300 IEM G2 transmitter

For mounting one or two transmitters into a 19" rack, you require the GA 2 rack adapter. The GA 2 rack adapter consists of:

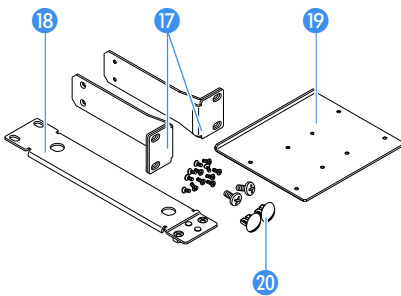

- 2 rack mount "ears" 17
- 1 blanking plate 18
- 1 jointing plate 19
- 2 blanking plugs 20 for closing off unused BNC holes
- 12 recessed head screws M 3x6
- 2 recessed head screws M 6x10

To mount **two transmitters** side by side into a rack:

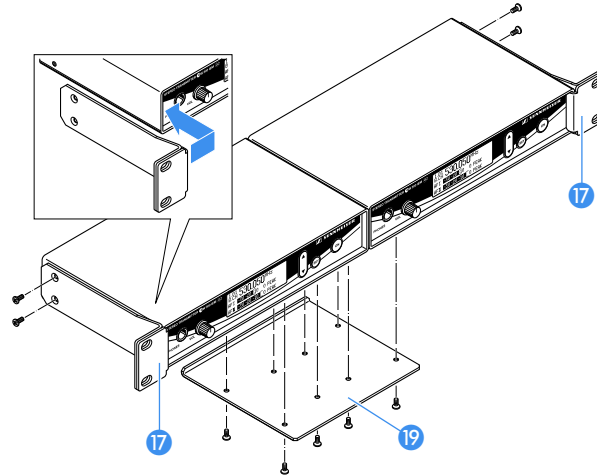

- ▶ Place the two transmitters side by side upside-down onto a flat surface.
- ▶ Align the jointing plate 19 over the holes in the bottom sides of the transmitters.
- ▶ Secure the jointing plate 19 to the transmitters using eight of the supplied recessed head screws (M 3x6).
- ▶ Hook the two rack mount "ears" 18 to the front panels of the transmitters.
- ▶ Secure the rack mount "ears" to the transmitters using two of the supplied recessed head screws (M 3x6) respectively.
- ▶ Slide the transmitters into the 19" rack.
- ▶ Secure the rack mount "ears" to the rack.

When mounting only one transmitter into a rack, use the blanking plate 18 instead of the second transmitter.

To mount only **one transmitter** into a rack:

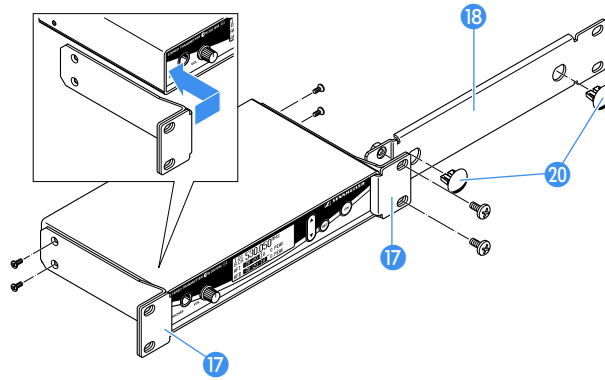

- ▶ Hook the two rack mount "ears" 17 to the front panel of the transmitter.
- ▶ Secure the rack mount "ears" to the transmitter using two of the supplied recessed head screws (M 3x6) respectively.
- ▶ Secure the blanking plate 18 to one of the rack mount "ears" 17 using two of the supplied recessed head screws (M 6x10).
- ▶ If you are not front mounting the BNC output connector, insert the two blanking plugs 20 into the holes of the blanking plate.
- ▶ Slide the transmitter into the 19" rack.
- ▶ Secure the rack mount "ears" to the rack.

Connecting the antenna

Connecting the antenna to the rear of the transmitter

The supplied telescopic antenna can be mounted quickly and easily and are suitable for all applications where – good transmission conditions provided – a wireless transmission system is to be used without a large amount of installation work.

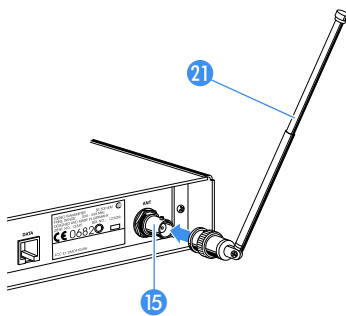

- ▶ Connect the telescopic antenna to the BNC socket 15 at the rear of the transmitter.
- ▶ Pull the end cap to extend the telescopic antenna 21.

Use a remote antenna (available as an accessory) when the transmitter position is not the best antenna position for optimum transmission.

Antenna front mounting

When mounting only one SR 300 IEM G2 transmitter or one SR 350 IEM G2 twin transmitter into a rack, you can use an antenna mount (optional accessory) to mount the transmitter's antenna connection to the front of the rack.

Use the antenna mount matching the respective transmitter:

- For the SR 300 IEM G2 transmitter: AM 2 antenna mount
- For the SR 350 IEM G2 twin transmitter: GA 3030 AM antenna mount

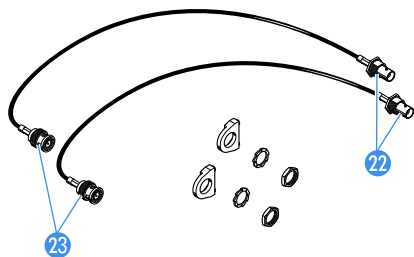

The antenna mounts consist of:

- 2 BNC extension cables (screw-in BNC socket 22 to BNC connector 23)
- 2 washers
- 2 nuts
- 2 antenna holders (GA 3030 AM only)
- 4 screws (GA 3030 AM only)

To front mount the antenna of the **SR 300 IEM G2 transmitter**:

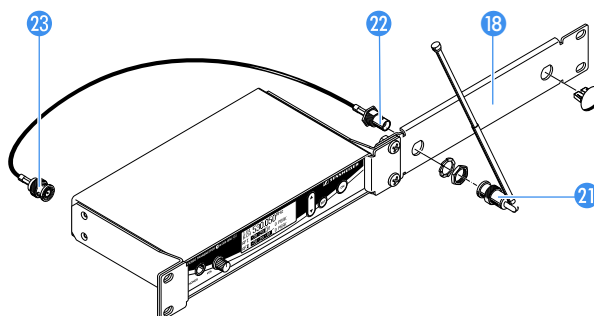

- ▶ Screw the BNC socket 22 of the BNC extension cables to the blanking plate 18 using the supplied washer and nut.
- ▶ Connect the BNC connector 23 to the BNC socket 15 on the transmitter.
- ▶ Slide the transmitter into the 19" rack.
- ▶ Secure the rack mount "ears" to the rack.
- ▶ Connect the telescopic antenna 21 to the BNC socket 22.
- ▶ Pull the end cap to extend the telescopic antenna 21.

To front mount the antennas of the **SR 350 IEM G2 twin transmitter**:

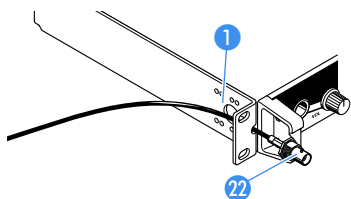

- ▶ Unsecure the rack mount "ears" 1 from the rack.
- ▶ Guide the BNC cables through the holes in the rack mount "ears" as shown in the diagram on the left.

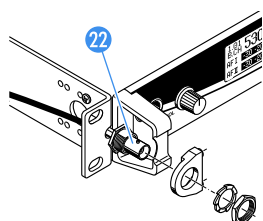

- ▶ Screw the antenna holders to the BNC sockets 22 using the supplied washers and nuts.

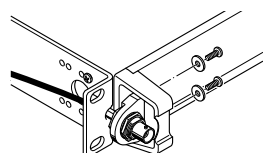

- ▶ Secure the antenna holders to the handles of the twin transmitter using two of the supplied screws respectively.

- ▶ Connect the two BNC connectors 23 to the BNC sockets 15 on the twin transmitter.

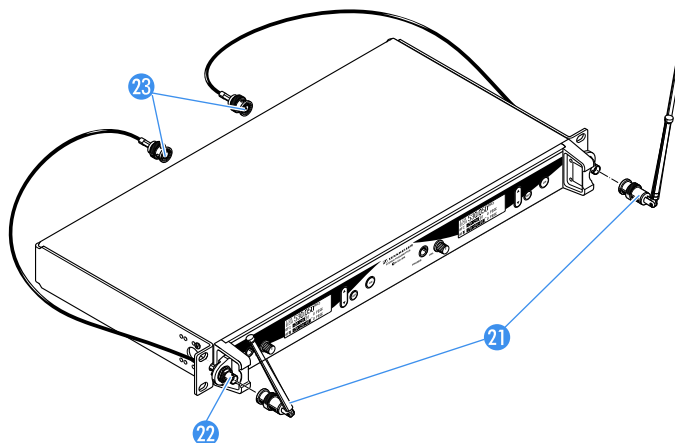

- ▶ Slide the twin transmitter into the 19" rack.
- ▶ Resecure the rack mount "ears" 1 to the rack 1.
- ▶ Connect the telescopic antennas 21 to the BNC sockets 22.
- ▶ Pull the end caps to extend the telescopic antennas 21.

Changing the transmission power (SR 350 IEM G2 only)

With the SR 350 IEM G2 twin transmitter, you can choose between two different transmission powers.

ATTENTION! Danger of interference with other transmitters!



Depending on the selected transmission power and frequency, you may have to apply for an approval from the respective authority for a radio transmission licence, as you could interfere with other transmitters. This approval will only be valid for the approved transmission power. For detailed information, please refer to the enclosed frequency data sheets and to the country-specific frequency and transmission power overviews.

- ▶ Apply for an approval, should country-specific regulations on frequency and/or transmission power usage require this.

ATTENTION! Danger of damage to the device!



Due to the high transmission power (100 mW) in the switch position "STANDARD", the optional AC 2 transmitter combiner must not be used as this can cause damage to the devices.

- ▶ Use only the optional AC 3200 transmitter combiner (see "Accessories and spare parts" on page 40).

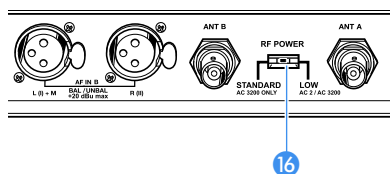

- ▶ Set the transmission power switch (RF POWER) 16 to the desired position. Transmission power will change as follows:

Switch position	Transmission power
LOW	15 mW
STANDARD	100 mW

Connecting the transmitter to the mains

CAUTION! Damage due to electric current!



If you connect the transmitter to an unsuitable power supply, this can cause damage to the device.

- ▶ Use the supplied mains cable to connect the receiver to the mains (100 to 240 V AC, 50 or 60 Hz).
- ▶ Ensure a reliable mains ground connection of the receiver – especially when you are using multi-outlet power strips or extension cables.

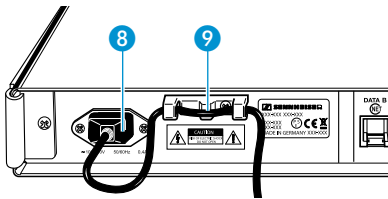
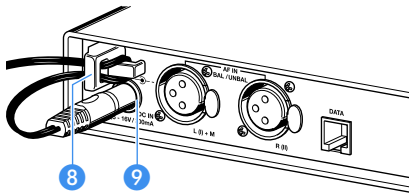

Both transmitters have no mains switch.
To connect the transmitter to the mains:

- ▶ Pass the cable through the cable grip 9.
- ▶ Connect the supplied mains cable to the 3-pin IEC mains socket 8.
- ▶ Plug the mains connector into the wall socket.

To disconnect the transmitter from the mains:

- ▶ Pull out the mains connector from the wall socket.

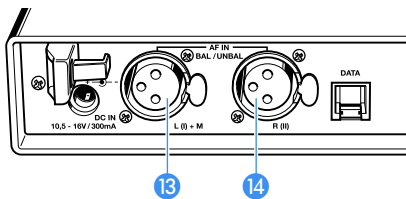

Connecting the amplifier/mixing console

- ▶ Connect the amplifier/mixing console to the XLR-3F sockets 13 (left and MONO) or 14 (right).

Both balanced and unbalanced connection is possible (see “Connector assignment” on page 39).

Note:

Any device that is only suitable for mono operation must be connected to XLR-3F socket 13. In this case, set the transmitter to mono operation via the menu.

- ▶ Via the “Sensitiv” menu, adjust the transmitter’s input sensitivity (see “Adjusting the sensitivity (transmitter only)” on page 30).

Menu	
Tune	797.075MHz
Sensitiv	-24 dB
Display	Frequency

Connecting the headphones/ monitoring the audio signal

CAUTION! Danger of hearing damage!



Listening at high volume levels for long periods can lead to permanent hearing defects.

- ▶ Set the volume for the connected headphones to the minimum before putting the headphones on.

To monitor the audio signal:

- ▶ Set the headphone volume control 3 to the lowest volume by turning it to the left as far as possible.
- ▶ Connect headphones with a 1/4" (6.3 mm) stereo jack plug to the headphone output (PHONES) 2.
- ▶ Gradually turn up the volume.

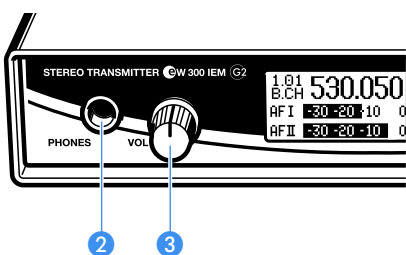

Service interface/ connection to the NET 1 network system

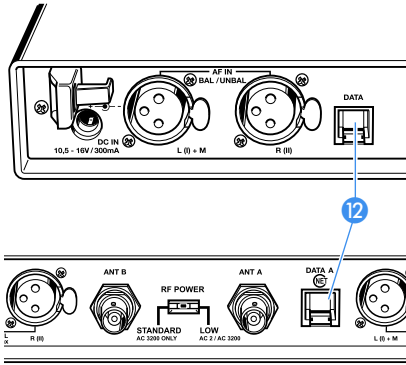

The service interface (DATA A/B) 12 is only required for servicing purposes. In addition, the interface can also be used for connecting the transmitter to the NET 1 network system. For detailed information, please refer to the user manual of the NET 1.

EK 300 IEM G2 receiver

Inserting and replacing the batteries

For powering the EK 300 IEM G2 receiver, two 1.5 V AA size batteries are required.

- ▶ Press the two release buttons 10 and open the battery compartment cover 9.
- ▶ Insert the two batteries as shown in the diagram on the left. Please observe correct polarity when inserting the batteries.
- ▶ Close the battery compartment. The battery compartment cover 9 locks into place with an audible click.

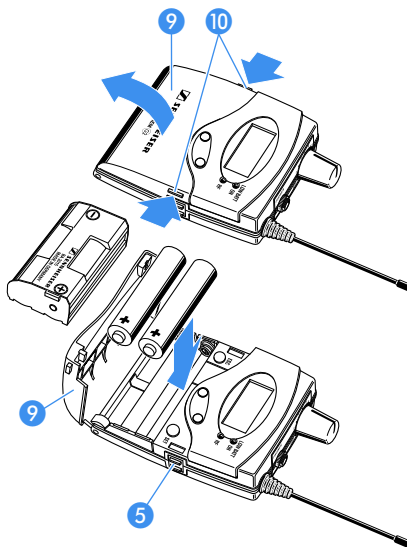

Inserting and charging the accupack

The receiver can also be powered via the rechargeable Sennheiser BA 2015 accupack. Insert the accupack into the battery compartment as described above.

The receiver has two charging contacts 5 and a sensing contact on its short sides. The accupack can be recharged while remaining in the receiver. Insert the receiver into the L 2015 charger (see user manual of the L 2015 charger).

Note:

For accupack operation of the receiver, only use the BA 2015 accupack in order to ensure optimum operational reliability. For charging the accupack, only use the L 2015 charger. Both the accupack and the charger are available as accessories.

The accupack is fitted with an integrated sensor which is – via a third contact – monitored by the electronics of the receiver and the charger. The sensor is necessary for the following control purposes:

- The taking into account of the different voltage characteristics of primary cells (batteries) and accupacks. The battery status indications on the displays, the transmission of transmitter battery status information to the rack-mount receivers and the switch-off thresholds at the end of the operating time are corrected correspondingly. Due to the missing sensor, individual rechargeable battery cells will not be identified as accupacks.
- The monitoring of the accupack temperature during charging in the L 2015 charger.
- The prevention of improper charging of inserted primary cells (batteries). Due to the missing sensor, individual rechargeable battery cells will also not be charged in the L 2015 charger.

Connecting the headphones

CAUTION! Danger of hearing damage!



Listening at high volume levels for long periods can lead to permanent hearing defects.

- ▶ Set the volume for the connected headphones to the minimum before putting the headphones on.

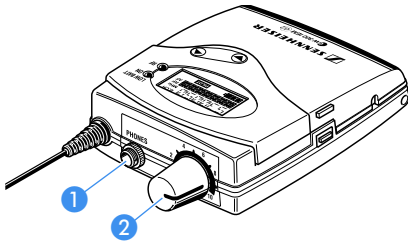

- ▶ For monitoring purposes, connect the supplied earphones or any Sennheiser stereo headphones with 3.5 mm stereo jack plug to the headphone output (PHONES) ①.
- ▶ First, set the volume control ② to the lowest volume by turning it to the left as far as possible. Then gradually turn up the volume.

Using the components

Switching the components on/off

Switching the transmitter on/off

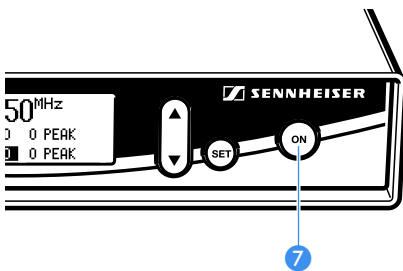

- ▶ Press the ON button ⑦ to switch the transmitter on.
- ▶ To switch the transmitter off, press the ON button until "OFF" appears on the display.

Note:

The transmitter can only be switched off when the standard display is shown on the display panel. Within the operating menu, the ON button serves as the ESC (cancel) key, i.e. you cancel your entry and return to the standard display.

After switch-off, the transmitter is in standby mode. To disconnect the transmitter from the mains, pull out the mains connector from the wall socket!

Switching the receiver on/off

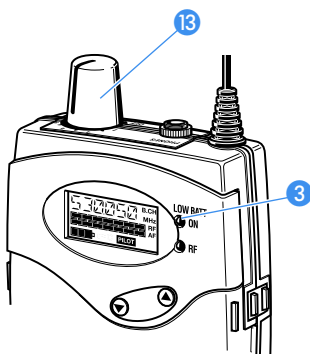

- ▶ To switch the receiver on, turn the volume control ⑬ clockwise until it clicks. The red LED ③ lights up.
- ▶ To switch the receiver off, turn the volume control ⑬ counterclockwise until it clicks. The red LED ③ goes off.

Note:

- The receiver has a short switch-on delay.
- Remove the batteries or the accupack when the receiver will not be used for extended periods of time.

Adjusting the volume

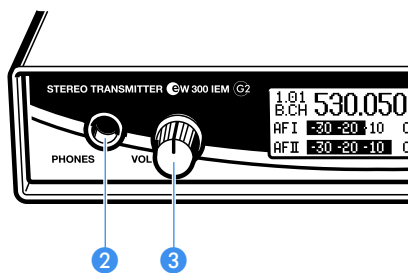

CAUTION! Danger of hearing damage!



Listening at high volume levels for long periods can lead to permanent hearing defects.

- ▶ Set the volume for the connected headphones to the minimum before putting the headphones on.

You can adjust the volume at the headphone output on both the transmitter and the receiver.

- ▶ Use the volume control **3** or **13** to adjust the volume of the connected headphones.

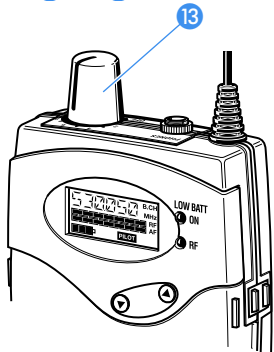

Adjusting the balance

During stereo operation – and provided that the standard display is shown on the display panel – the ▼/▲ rocker button **7** serves to adjust the balance between the left and right stereo signal.

During FOCUS operation, the ▼/▲ rocker button **7** serves to adjust the relative levels of the two separate channels in the mixed mono signal (see “Stereo/FOCUS selection (receiver only)” on page 30).

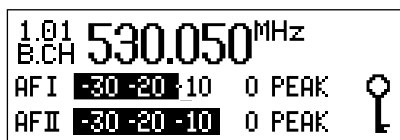
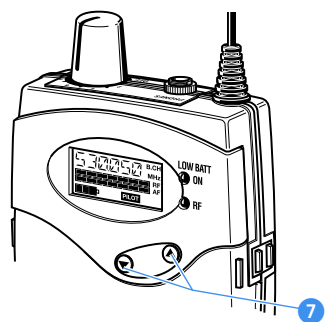

SR 300 IEM G2/SR 350 IEM G2

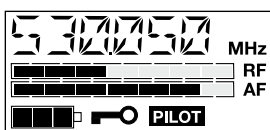

EK 300 IEM G2

Activating/deactivating the lock mode

Transmitter and receiver have a lock mode that can be activated or deactivated via the operating menu (see “Activating/deactivating the lock mode” on page 33). The lock mode prevents that

- the transmitter is accidentally programmed or switched off during operation,
- the balance setting is accidentally changed via the receiver’s ▼/▲ rocker button.

Attaching the receiver to clothing

The receiver is attached to clothing (e.g. belt, waistband) with the supplied belt clip.

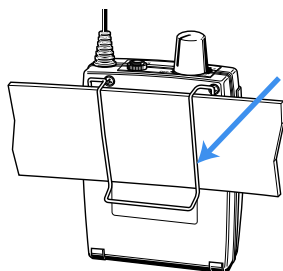

The operating menu

To ensure intuitive operation of both transmitter and receiver, the operating menus have been largely standardized. As a result, adjustments to the settings can be made quickly and “without looking” – even in stressful situations, for example on stage or during a live show or presentation.

The buttons

Buttons	Mode	To ...
ON (transmitter only)	Standard display	switch the transmitter on and off
	Operating menu	cancel the entry and return to the standard display
	Setting mode	cancel the entry and return to the standard display
SET	Standard display	get into the operating menu
	Operating menu	get into the setting mode of the selected menu
	Setting mode	store the settings and return to the previous menu level
▲/▼	Standard display	without function (transmitter) adjust the balance (receiver)
	Operating menu	change to the previous menu (▲) or change to the next menu (▼)
	Setting mode	adjust the setting of the selected menu: option (▲/▼)
ESC (receiver only)	Standard display	without function
	Operating menu	cancel the entry and return to the standard display
	Setting mode	cancel the entry and return to the standard display

Overview of menus

Transmitter		Receiver	
Display	Function of the menu	Display	Function of the menu
Bank	Switching between channel banks	BANK	Switching between channel banks
Channel	Switching between the channels in a channel bank	CHAN	Switching between the channels in a channel bank
Tune	Setting a transmission frequency for the channel bank "U" (user bank)	TUNE	Setting a receiving frequency for the channel bank "U" (user bank)
—	—	SCAN	Scanning a channel bank for free channels
—	—	SQELCH	Adjusting the squelch threshold
—	—	ST-FOC	Stereo/FOCUS selection
—	—	LTD	Limiting the volume at the headphone output
—	—	Hi-BST	Activating/deactivating the frequency boost
Sensitiv	Adjusting the sensitivity	—	—
Display	Selecting the standard display	DISPLY	Selecting the standard display
Name	Entering a name	NAME	Entering a name
Reset	Loading the factory-preset default settings	RESET	Loading the factory-preset default settings
—	—	PILOT	Activating/deactivating the pilot tone evaluation
LCD Contr	Adjusting the contrast of the graphic display	—	—
Mode	Stereo/mono selection	—	—
Lock	Activating/deactivating the lock mode	LOCK	Activating/deactivating the lock mode
Exit	Exiting the operating menu and returning to the standard display	EXIT	Exiting the operating menu and returning to the standard display

Working with the operating menu

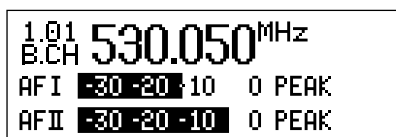

SR 300 IEM G2/SR 350 IEM G2

By way of example of the "Tune" menu, this section describes how to use the operating menu.

After switching the unit on, the standard display is shown on the display panel.

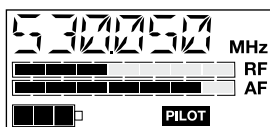

EK 300 IEM G2

Getting into the operating menu

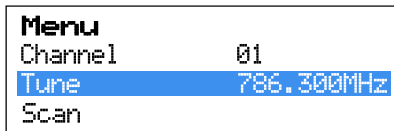

```
Menu
Channel 01
Tune 786.300MHz
Scan
```



```
TUNE
```

- ▶ Press the **SET** button to get from the standard display into the operating menu.

The last menu selected flashes on the display. With the transmitter, the current setting is additionally displayed.

Selecting a menu



```
Tune
U.01
B.CH 786.300 MHz
```

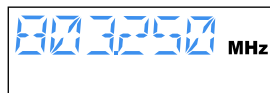

```
803.250 MHz
```

- ▶ Press the **▼/▲** rocker button to select a menu.
- ▶ Press the **SET** button to get into the setting mode of the selected menu. With the receiver, the current setting that can be adjusted flashes on the display. With the transmitter, the name of the menu and the current setting are displayed.

Adjusting a setting



```
Tune
U.01
B.CH 786.425 MHz
```

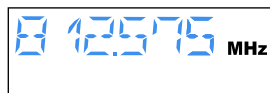

```
812.575 MHz
```

- ▶ Press the **▼/▲** rocker button to adjust the setting. By briefly pressing the **▼/▲** rocker button, the display jumps either forwards or backwards to the next setting. In the “**Channel**”, “**Tune**” and “**Name**” menu, the **▼/▲** rocker button features a “fast search” function. If you hold down a button, the display cycles continuously. The “fast search” function allows you to get fast and easily to your desired setting. With the receiver, the new setting flashes on the display until it is stored.

Storing a setting



```
Stored
```



```
STORE II
```

- ▶ Press the **SET** button to store the setting. “Stored” appears on the display, indicating that the setting has been stored. The display then returns to the top menu level.

With most menus, new settings become effective immediately without having to be stored. An exception are the “**Bank**”, “**Channel**”, “**Tune**” and “**Reset**” menus of the transmitter and the “**RESET**” menu of the receiver. With these menus, new settings only become effective after they have been stored (“Stored” appears on the display, indicating that the setting has been stored).

Exiting the operating menu

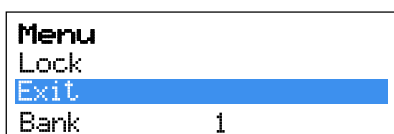

```
Menu
Lock
Exit
Bank 1
```



```
EXIT
```

- ▶ Select the “**Exit**” menu to exit the operating menu and to return to the standard display.

When you have entered the operating menu, the transmitter’s **ON** button serves as the ESC (cancel) key, i.e. by briefly pressing this button, you cancel your entry and return to the standard display. The receiver has a separate **ESC** button with which you can cancel your entry.

Operating menu of the stereo transmitter

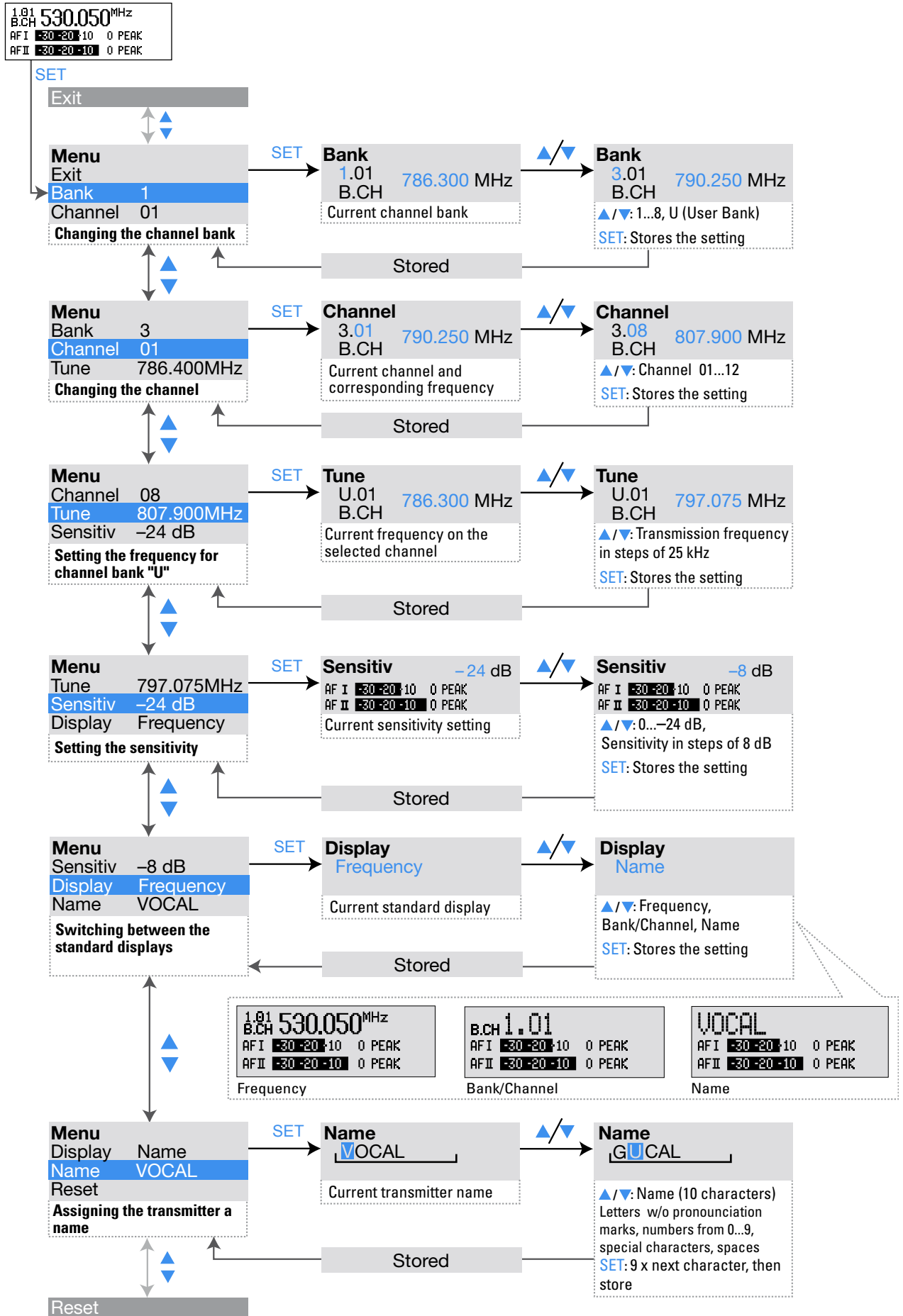

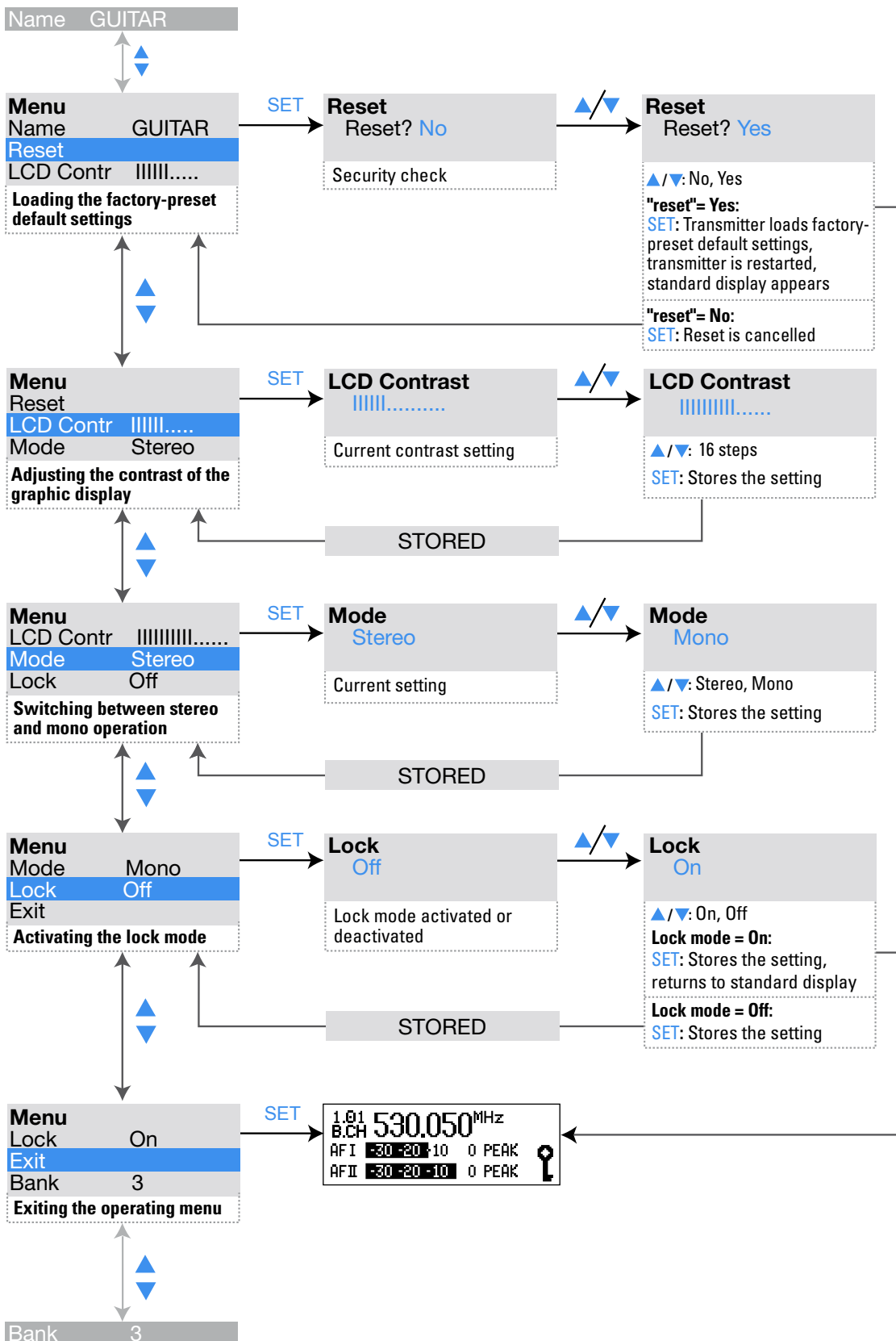

Operating menu of the stereo receiver

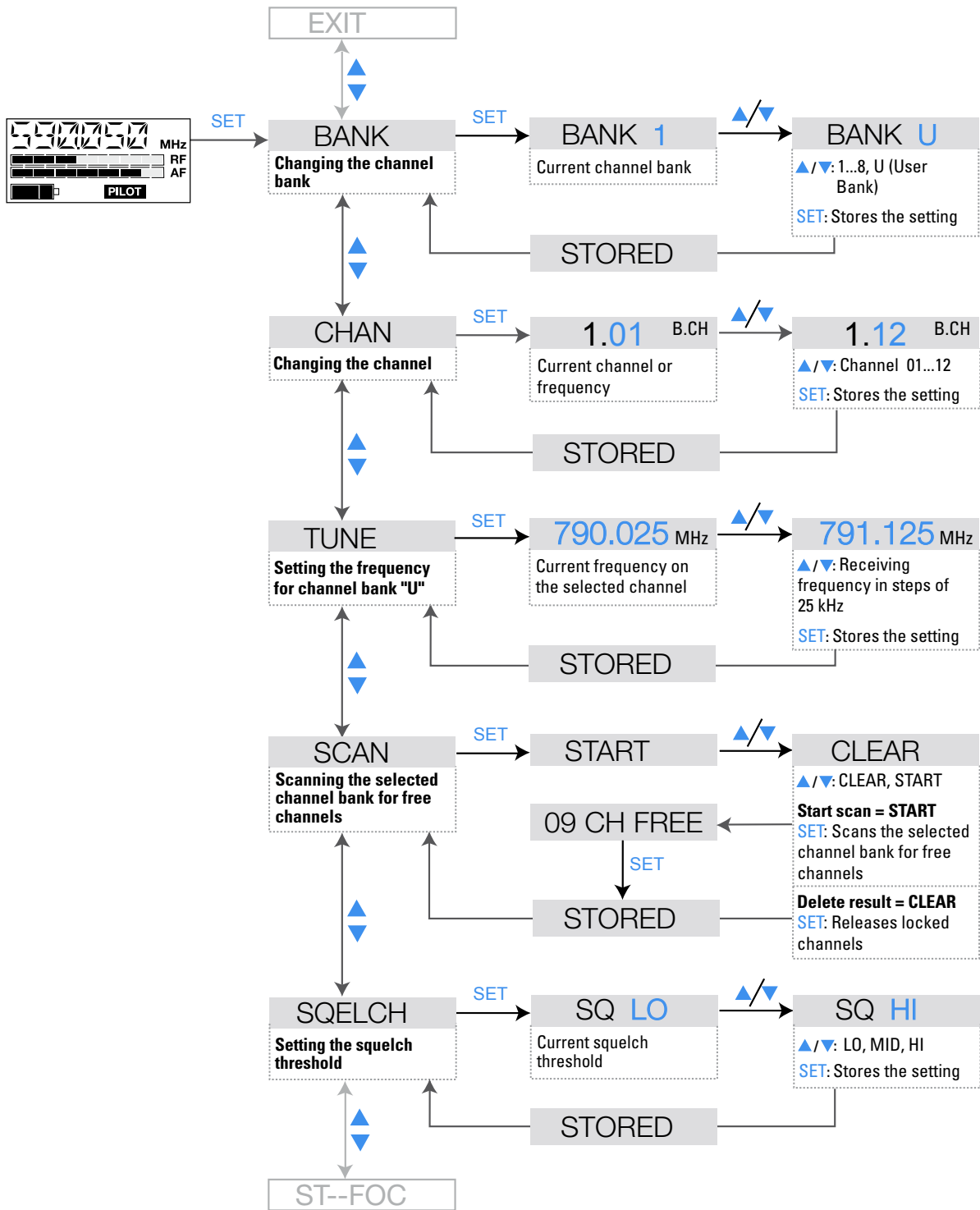

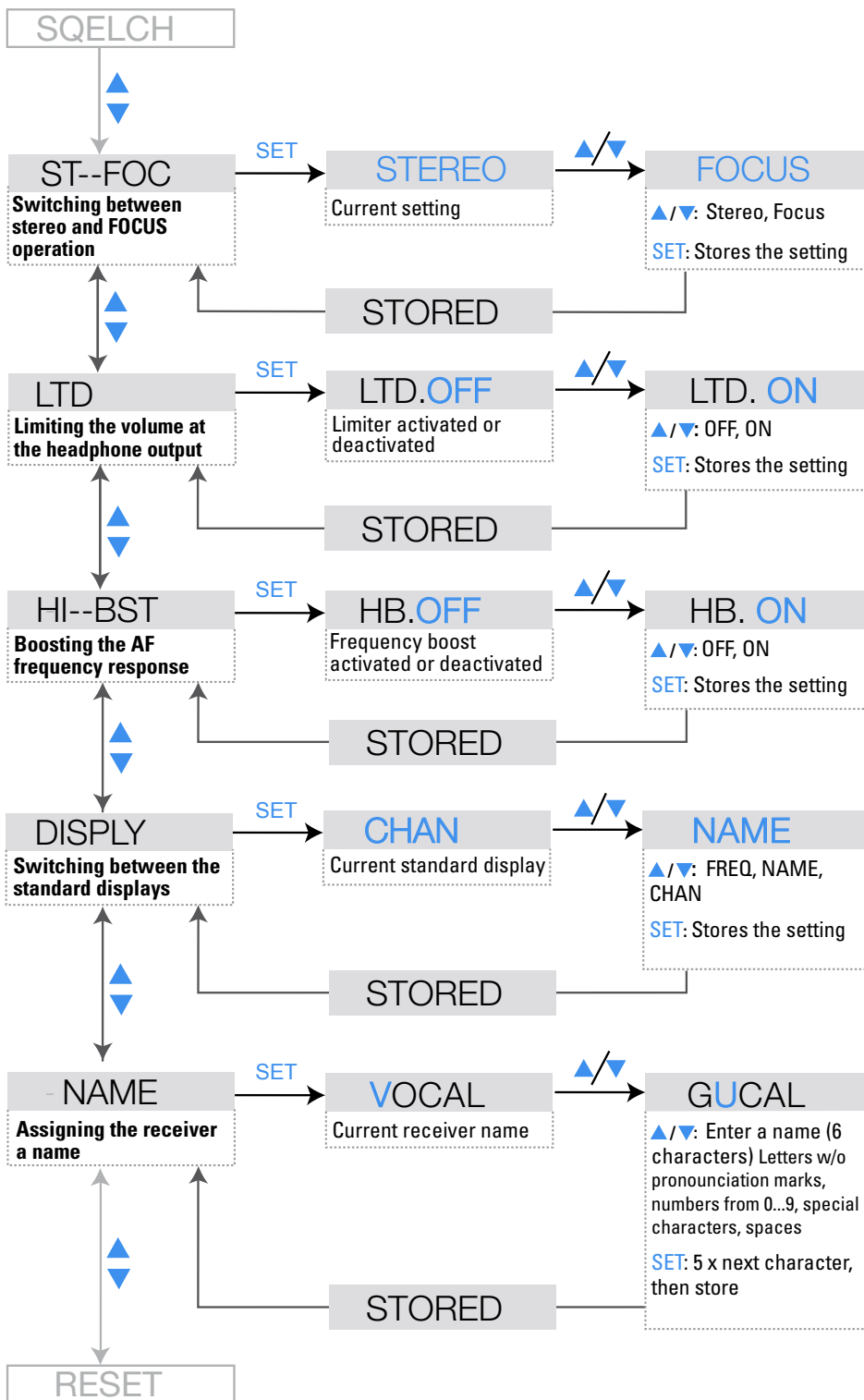

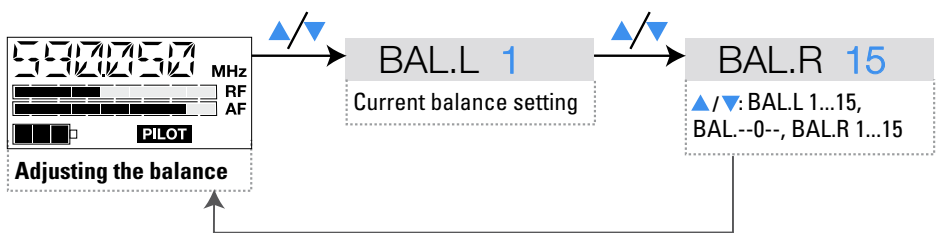
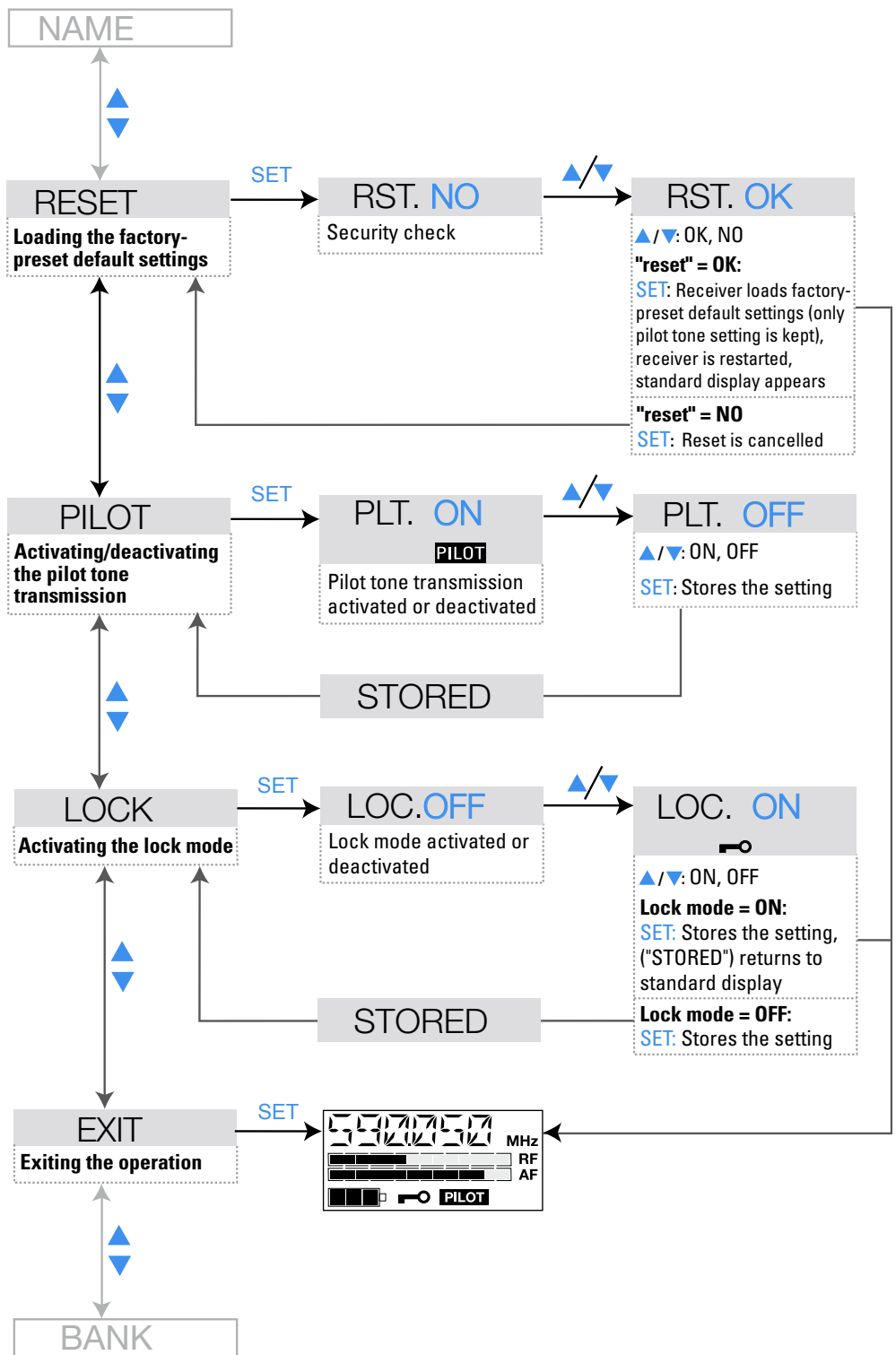

Adjustment tips for the operating menu

BANK Bank

Switching between channel banks

Via the “Bank” menu, you can switch between the nine channel banks of the ew 300 IEM G2 transmitter and receiver. The channel banks “1” to “8” have up to 12 switchable channels that are factory-preset to a transmission/receiving frequency (see “The channel bank system” on page 5). The channel bank “U” (user bank) also has up to 12 switchable channels to store your selection out of 1,440 transmission/receiving frequencies that are freely selectable within the preset frequency range.

When switching from one channel bank to another, the channel with the lowest channel number is automatically displayed. If, during the last scan of this channel bank, an interfering frequency was detected on the channel with the lowest channel number, the receiver display panel automatically displays the next free channel (see below).

CHAN Channel

Switching between the channels in a channel bank

Via the “Channel” menu, you can switch between the channels in a channel bank.

Always set the transmitter and the receiver of a transmission link to the same channel. After scanning a channel bank (see “Scanning the channel banks for free channels (receiver only)” on page 28), only the free channels are displayed. Set the transmitter to one of the free channels.

TUNE Tune

Selecting the frequencies to be stored in the channel bank “U”

Via the “Tune” menu, you can select the frequencies to be stored in the channel bank “U” (user bank).

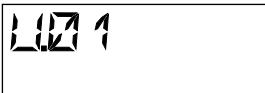

When you have selected one of the channel banks “1” to “8” and then select the “Tune” menu, the transmitter or receiver automatically switches to channel 01 of the channel bank “U”. In this case, “U.01” briefly appears on the display.

- ▶ Use the ▼/▲ rocker button to select the desired transmission or receiving frequency. Transmission and receiving frequencies are tunable in 25-kHz steps within a switching bandwidth of 36 MHz max. For intermodulation-free frequencies, please refer to the enclosed frequency table.

SCAN

Scanning the channel banks for free channels (receiver only)

Before putting one or several transmission links into operation, you should scan the selected channel bank for free channels.

Starting the scan and storing the scan result

- ▶ Before starting the scan, switch all transmitters of your system off, since channels used by switched-on transmitters will not be displayed as “free channels”.
- ▶ Select the “SCAN” menu.

- ▶ Select “START” and confirm your selection by pressing the SET button. After the scan is completed, the number of free channels is displayed. Pressing the SET button once more will store the scan result and lock all channels that are used or subject to interference.

Releasing locked channels

- ▶ Select the “SCAN” menu.
- ▶ Select “CLEAR” and confirm your selection by pressing the SET button. All channels in this channel bank can now be selected again.

Multi-channel operation

For multi-channel operation, only use the free channels in a channel bank.

Before putting the transmission links into operation, we recommend performing an auto scan.

- ▶ Select a channel bank on a receiver.
- ▶ Scan this channel bank for free channels. If not enough free channels are available in the selected channel bank, repeat the scan with another channel bank.
- ▶ Apply the scan result to all other transmitters and receivers.

Note:



If you have the SR 350 IEM G2 twin transmitter connected to the NET 1 network system, follow the instructions of the user manual of the NET 1.

Adjusting the squelch threshold (receiver only)

SQUELCH

The receiver is equipped with a squelch that can be adjusted via the “SQUELCH” menu. The squelch eliminates annoying noise when the transmitter is switched off. It also suppresses sudden noise when there is no longer sufficient transmitter power received by the receiver.

Note:

Before adjusting the squelch threshold to a different setting, use the volume control 13 to set the volume for the connected headphones to the minimum.

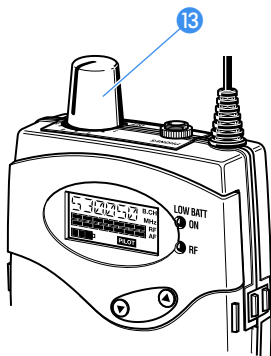

There are three possible squelch settings:

- LO = low
- MID = middle
- HI = high

Selecting the setting “LO” reduces the squelch threshold, selecting the setting “HI” increases the squelch threshold. Adjust the squelch threshold – with the transmitter switched off – to the lowest possible setting that suppresses hissing noise.

Notes:

- If the squelch threshold is adjusted too high, the transmission range will be reduced. Therefore, always adjust the squelch threshold to the lowest possible setting.
- When in the setting mode of the “SQUELCH” menu, pressing the ▼ button for more than three seconds will switch the squelch off. “SQ.OFF” appears on the display. If no RF signal is being received, hissing noise will occur. This setting is for test purposes only.

Stereo/FOCUS selection (receiver only)

ST-FOC

Via the “ST-FOC” menu, you can switch between stereo and FOCUS operation.

In both operating modes, the transmitter has to be set to stereo operation.

When the receiver is set to stereo operation, the left-right signals are available as usual.

When the receiver is set to FOCUS operation, the left-right signals are mixed and are available as a mono signal in both headphone channels. Use the ▼/▲ rocker button to adjust the relative levels of the two separate channels in the mixed mono signal (see “Adjusting the balance” on page 19).

Limiting the volume at the headphone output (receiver only)

LTD

Via the “LTD” menu, you can switch the limiter on and off. With the limiter switched on, the volume at the headphone output will be reduced.

Activating/deactivating the frequency boost (receiver only)

HI-BST

Via the “HI-BST” menu, you can boost the AF frequency response at 10 kHz. As a result, headphones with magnetic transducers sound better.

Adjusting the sensitivity (transmitter only)

Sensitiv

To match the transmitter to the output level of the connected unit (e.g. mixing console), you can adjust the input sensitivity in four steps of 8 dB (from 0 to -24 dB) via the “Sensitiv” menu.

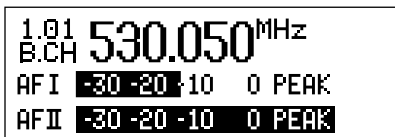

The input sensitivity is adjusted too high when close talking distances, speakers with loud voices or loud music passages cause overmodulation in the transmission link. In this case, the transmitter's “PEAK” warning will light up and the receiver's level display for audio signal “AF” will show full deflection.

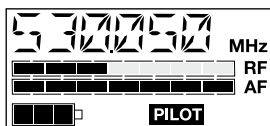

If, on the other hand, the sensitivity is adjusted too low, the transmission link will be undermodulated, which would result in a signal with high background noise.

The sensitivity is correctly adjusted when the level display for audio signal “AF” shows full deflection only during the loudest passages.

DISPLY Display

Selecting the standard display

Via the "Display" menu, you can select the standard display.

SR 300 IEM G2 transmitter/SR 350 IEM G2 twin transmitter

Selectable standard display	Contents of standard display
"Frequency" (display of the frequency)	<p>1.01 530.050 MHz B.CH AF I -30 -20 -10 0 PEAK AF II -30 -20 -10 0 PEAK</p>
"Bank/Channel" (display of the channel bank and channel number)	<p>B.CH 1.01 AF I -30 -20 -10 0 PEAK AF II -30 -20 -10 0 PEAK</p>
"Name" (display of the freely selectable name)	<p>VOCAL AF I -30 -20 -10 0 PEAK AF II -30 -20 -10 0 PEAK</p>

EK 300 IEM receiver

Selectable standard display	Contents of standard display
"FREQ"	<p>530.050 MHz RF AF PILOT</p>
"NAME"	<p>VOCAL RF AF PILOT</p>
"CHAN"	<p>101 B.CH 1 RF AF PILOT</p>

NAME Name

Entering names

Via the "Name" menu, you can enter a freely selectable name for the transmitter and the receiver. You can, for example, enter the name of the performer for whom the adjustments have been made.

The name can be displayed on the standard display and can consist of up to ten characters (transmitter) and up to six characters (receiver) such as:

- letters (without pronunciation marks),
- numbers from 0 to 9,
- special characters e.g. () - . _ and spaces.

To enter a name, proceed as follows:

- ▶ Press the **SET** button to get into the setting mode of the "Name" menu. The first segment starts flashing on the display.
- ▶ With the ▼/▲ rocker button you can now select a character. By briefly pressing a button, the display jumps either forwards or backwards to the next character. If you hold down a button, the display starts cycling continuously.
- ▶ Press the **SET** button to change to the next segment and select the next character.
- ▶ Have you entered the name completely? Press the **SET** button to store your setting and to return to the previous menu level.

Loading the factory-preset default settings

RESET Reset

Via the "Reset" menu, you can load the factory-preset default settings. With the receiver, however, the selected setting for the pilot tone remains unchanged. After the reset, the device is restarted and the standard display is shown on the display panel.

Activating/deactivating the pilot tone evaluation (receiver only)

PILOT Pilot

Via the "Pilot" menu, you can activate or deactivate the pilot tone evaluation of the receiver.

The pilot tone is used to

- code the transmitter's stereo signal,
- support the squelch function (Squelch).

During stereo operation, the transmitter adds the pilot tone to the transmitted stereo signal and the receiver detects and evaluates the pilot tone. When the transmitter is set to mono operation, deactivate the pilot tone evaluation on the receiver.

You can combine units of first and second generation ew 300 IEM systems without any problems.

Adjusting the contrast of the graphic display (transmitter only)

LCD-Contr

Via the "LCD Contr" menu, you can adjust the contrast of the graphic display in 16 steps.

Stereo/mono selection (transmitter only)

Mode

Via the “Mode” menu, you can switch the transmitter between mono and stereo operation.

Note:

Connect any unit that only delivers a mono signal to the transmitter’s left XLR-3F socket 13 and set the transmitter to mono operation. The receiver automatically “identifies” the transmitted audio signal and does not need to be set to mono operation. However, you have to deactivate the pilot tone evaluation on the receiver.

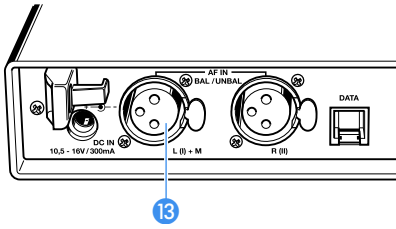

Activating/deactivating the lock mode

Via the “Lock” menu, you can activate or deactivate the lock mode.

LOCK Lock

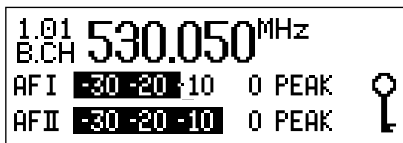

SR 300 IEM G2/SR 350 IEM G2

The lock mode icon on the display indicates that the lock mode is activated.

To deactivate the lock mode, first press the SET button. Then press the ▼/▲ rocker button to select “LOC.OFF”. If you confirm your selection by pressing the SET button, the buttons can be operated as usual.

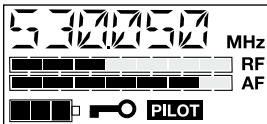

EK 300 IEM G2

Exiting the operating menu

EXIT Exit

Via the “Exit” menu, you can exit the operating menu and return to the standard display.

If a problem occurs ...

Error checklist

Problem	Possible cause	Possible solution
No operation indication	Batteries are flat or accupack is flat (receiver only)	Replace the batteries or recharge the accupack
	No mains connection (transmitter only)	Check the connections of the mains unit
No RF signal	Transmitter and receiver are not on the same channel	Set transmitter and receiver to the same channel
	Transmission range is exceeded	Check the squelch threshold setting (see "Adjusting the squelch threshold (receiver only)" on page 29) or reduce the distance between transmitting antenna and receiver
RF signal available, no audio signal, "MUTE" display appears on the display panel	Transmitter is set to mono operation and the pilot tone evaluation of the receiver is activated	Deactivate the pilot tone evaluation on the receiver
	Receiver's squelch threshold is adjusted too high	See "Adjusting the squelch threshold (receiver only)" on page 29
Audio signal has a high level of background noise	Transmitter sensitivity is adjusted too low	See "Adjusting the sensitivity (transmitter only)" on page 30
Audio signal is distorted	Transmitter sensitivity is adjusted too high	See "Adjusting the sensitivity (transmitter only)" on page 30
No access to a certain channel	During scanning, an RF signal has been detected on this channel and the channel has been locked	See "Scanning the channel banks for free channels (receiver only)" on page 28

If a problem occurs that is not listed in the above table or if the problem cannot be solved with the proposed solutions, please contact your local Sennheiser agent for assistance.

Recommendations and tips

... for the EK 300 IEM G2 receiver

- The antenna should hang freely and be at least 1 cm away from the body. The antenna must not be in direct contact with the skin.

... for optimum reception

- Transmission range depends to a large extent on location and can vary from about 10 m to about 150 m. There should be a “free line of sight” between transmitting and receiving antennas.
- If, with the SR 300 IEM G2 transmitter or the SR 350 IEM G2 twin receiver, transmission conditions are unfavourable, you should use a remote antenna which is connected via antenna cable.
- To avoid overmodulating the receiver, observe a minimum distance of 5 m between transmitting and receiving antennas.
- Observe a minimum distance of 50 cm between the transmitting antennas and metal objects (such as cross members or reinforced-concrete walls).

... for multi-channel operation

- For multi-channel operation, you can only use the channels in a channel bank. Each of the channel banks “1” to “8” accommodates up to 12 factory-preset frequencies which are intermodulation-free. For alternative frequency combinations, please refer to the enclosed frequency table. The freely selectable frequencies can be selected via the “Tune” menu and can be stored in the channel bank “U”.
- When using several transmitters simultaneously, interference can be avoided by maintaining a minimum distance of 20 cm between two transmitters. For multi-channel applications, use the appropriate transmitter combiners (see “Accessories and spare parts” on page 40):
 - SR 300 IEM G2 stereo transmitter:
AC 2 transmitter combiner
 - SR 350 IEM G2 twin transmitter:
AC 2 transmitter combiner (only when the transmission power is set to “LOW”) or AC 3200 transmitter combiner

Care and maintenance

Use a slightly damp cloth to clean the units from time to time.

Note:

Do not use any cleansing agents or solvents.

Additional information

HDX noise reduction

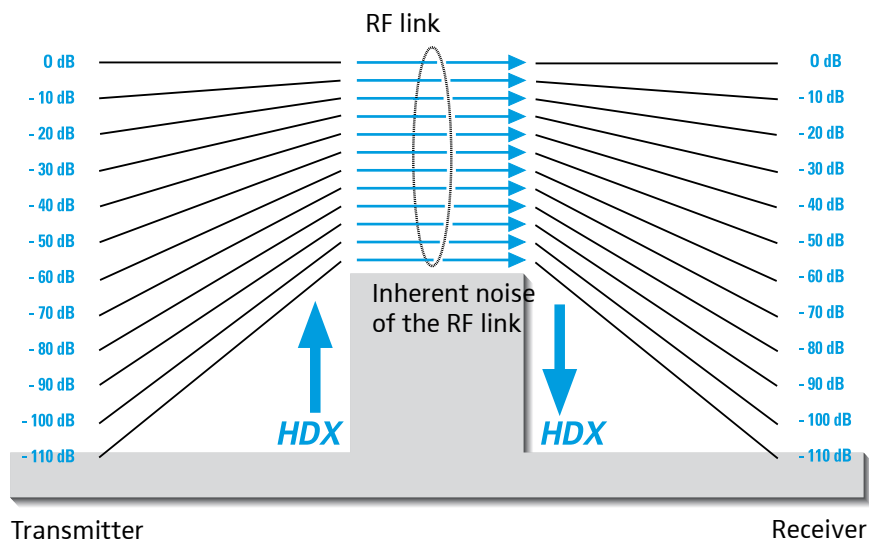

Progress you can hear:

The evolution wireless G2 series is equipped with HDX, the Sennheiser noise reduction system that reduces RF interference. It increases the signal-to-noise ratio in wireless audio transmission to more than 110 dB.

HDX is a wideband compander system which compresses the audio signal in the transmitter in a 2:1 ratio (related to dB) to lift it above the inherent noise floor of the RF link. In the receiver the signal is expanded in an identical and opposite way in a 1:2 ratio to restore the original signal, at the same time reducing the RF noise to below the noise floor of the receiver.

HDX has been specially developed for high quality radiomicrophone systems.

Note:

Only transmitters and receivers that are equipped with HDX can work correctly with each other. If non HDX equipment was mixed with HDX, the dynamic range would be drastically reduced and the transmission would sound blunt and flat. HDX is permanently active and cannot be switched off.

Wireless transmission systems

With the ew 300 IEM G2 system, Sennheiser puts an end to cable tangles and enables complete freedom of movement. The systems operate exclusively in the UHF band. UHF transmission is extremely reliable and is far less prone to interference than the overcrowded VHF band – harmonics from mains units, fluorescent tubes, refrigerators, computers, etc. are virtually eliminated. Also indoor propagation of UHF radio waves is better than VHF so that the RF power can be kept low – this is also an advantage when using multi-channel systems. Finally, UHF frequency ranges are being approved all over the world for radiomicrophone usage – in some countries licence-free.

Correct adjustment of transmitter sensitivity is vital. Too high and you get overmodulation and distortion, too low and you get undermodulation and a noisy signal. Please set the sensitivity correctly for the microphone/usage and check it before every performance to ensure best operation.

Squelch

Pilot tone squelch

The transmitter adds a 19-kHz pilot tone to the audio signal. The receiver checks incoming audio signals to see if the pilot tone is present. In the absence of the 19-kHz signal, the receiver's audio output will remain muted, even if a strong RF signal is present.

This prevents strong interfering signals from causing hissing noise in the receiver when the transmitter is switched off.

Field strength-dependent squelch

Depending on the strength of the received RF signal, the receiver's audio output is opened or muted. Via the "SQELCH" menu of the receiver, the squelch threshold can be adjusted in three steps (LO, MID, HI).

Specifications

System

RF characteristics

Modulation	wideband FM stereo, MPX pilot tone
Frequency ranges	518–554, 572–608, 626–662, 740–776, 786–822, 830–866 MHz
Transmission/receiving frequencies	8 channel banks with up to 12 factory-preset channels each 1 channel bank with up to 12 freely selectable channels (1,440 frequencies, tunable in steps of 25 kHz)
Switching bandwidth	36 MHz
Nominal/peak deviation	± 24 kHz/ ± 48 kHz
Frequency stability	$\leq \pm 15$ ppm

AF characteristics

Noise reduction system	Sennheiser HDX
AF frequency response	40–15,000 Hz
MPX pilot tone (frequency/deviation)	19 KHz/ ± 4 kHz
S/N ratio (at 1 mV and peak deviation)	≥ 91 dB(A)
THD (at nominal deviation and 1 kHz)	$\leq 0,9$ %

General data

Temperature range	-10 °C to $+55$ °C (with SR 350 IEM G2: -10 °C to $+45$ °C)
Dimensions of carrying case [mm]	380 x 370 x 70
Weight of carrying case	approx. 3 kg

IE 4 earphones

Frequency response	40–20,000 Hz
Max. SPL	106 dB (1 kHz, 1 mW)
Impedance	16 Ω

EK 300 IEM G2 receiver

RF characteristics

Receiver principle	non diversity
Sensitivity (with HDX, peak deviation)	< 2.5 μ V at 52 dB _{A,rms} S/N
Adjacent channel rejection	≥ 70 dB
Intermodulation attenuation	≥ 70 dB
Blocking	≥ 80 dB
Squelch	4 steps: OFF LO: 5 dB μ V MID: 15 dB μ V HI: 25 dB μ V
Pilot tone squelch (MPX pilot tone)	can be switched off

AF characteristics

Headphone output	3.5 mm jack socket
AF output voltage (peak deviation, 1 kHz _{AF}) PHONES	2 x ≥ 100 mW at 32 Ω

Overall device

Power supply	2 AA size batteries, 1.5 V
Nominal voltage	2.4 V
Max. power consumption at nominal voltage	approx. 190 mA (2 x 30 mW)
Power consumption with switched-off receiver	≤ 250 μ A
Operating time (with batteries)	6–10 hrs (depending on volume level)
Operating time (with BA 2015 accupack)	6–10 hrs (depending on volume level)
Dimensions [mm]	82 x 64 x 24
Weight (incl. batteries)	approx. 170 g

SR 300 IEM G2 transmitter/SR 350 IEM G2 twin transmitter

RF characteristics	SR 300 IEM G2	SR 350 IEM G2
RF output power at 50 Ω	20 mW	100 mW, switchable to 15 mW
ERP	depending on antenna type used	depending on antenna type used
Antenna output	BNC socket, 50 Ω	BNC socket, 50 Ω
AF characteristics		
Headphone output	¼" (6.3 mm) stereo jack socket	
Output power at headphone output	≥ 100 mW an 32 Ω (2x)	
AF input	2 x XLR-3 socket, electronically balanced	
Max. input voltage (peak deviation, 1 kHz)	+20 dB _u	
Input impedance	10 kΩ	
Overall device		
	SR 300 IEM G2	SR 350 IEM G2
Power supply	10,5–16 V DC	100–240 V AC/50–60 Hz
Nominal voltage	12 V DC	
Power consumption at nominal voltage	approx. 300 mA	approx. 400 mA
Dimensions [mm]	212 x 145 x 38	436 x 215 x 43
Weight	approx. 1100 g	approx. 3960 g

Type approvals

Area	Conformity	
	SR 300 IEM G2	SR 350 IEM G2
USA:	FCC-Part 74.861 FCC ID: DMOF2EUVL	FCC-Part 74.861 FCC ID: DMO3R350
Canada:	RSS-123 IC: 2099A - G2SREK	RSS-123 IC: 2099A-SR350
EU:	CE 0682 complies with the requirements for Radio and Telecommunications Terminal Equipment (R&TTE): <ul style="list-style-type: none"> • EN 300422-1/-2, class II • EN 301489-1/-9 complies with the requirements for safety (LVD): <ul style="list-style-type: none"> • EN 60065 	CE 0682 complies with the requirements for Radio and Telecommunications Terminal Equipment (R&TTE): <ul style="list-style-type: none"> • EN 300422-1/-2, class II • EN 300454-1/-2 • EN 301489-1/-9 complies with the requirements for safety (LVD): <ul style="list-style-type: none"> • EN 60065

Connector assignment

SR 300/350 IEM G2:

¼" (6.3 mm) stereo jack plug for headphone output

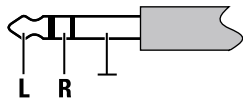

SR 300/350 IEM G2:

XLR-3M connector

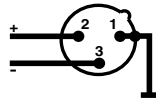

SR 300:

DC connector for power supply



EK 300 IEM G2:

3.5 mm stereo jack plug for headphone output

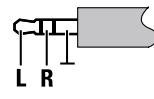

Accessories and spare parts

Cat. No. [Accessory/spare part](#)

- 009823** GA 2:
19" rack adapter
- 009912** AM 2 (for SR 300 IEM G2):
Antenna mount for mounting antennas to the front of the GA 2 rack adapter
- 004645** A 1031-U:
UHF antenna, passive, omni-directional, can be mounted onto a stand
- 003658** A 2003 UHF:
UHF antenna, passive, directional, can be mounted onto a stand
- 004368** GA 3030-AM (for SR 350 IEM G2):
Antenna mount
- 002324** GZL 1019-A1:
Antenna cable with BNC connectors, length: 1 m
- 002325** GZL 1019-A5:
Antenna cable with BNC connectors, length: 5 m
- 009822** AC 2:
Transmitter combiner, for combining the RF signals of up to four transmitters onto a single antenna and for powering up to four transmitters
- 502048** AC 3200:
Transmitter combiner, for combining the RF signals of up to eight transmitters onto a single antenna and for powering up to eight transmitters
- 004863** NT 3:
Plug-in mains unit for AC2
- 500432** IE 4:
1 pair of earphones with medium ear sleeves
- 512814** IES 4-L:
Ear sleeves, large (10 pieces)
- 512815** IES 4-M:
Ear sleeves, medium (10 pieces)
- 512816** IES 4-S:
Ear sleeves, small (10 pieces)
- 009950** BA 2015:
Accupack
- 009828** L 2015:
Charger for BA 2015 accupack
- 009826** CC 2:
Carrying case for ew 300 IEM G2 system

Manufacturer Declarations

Warranty

The original Sennheiser product you have purchased is covered by a warranty of 24 months. The warranty period begins on the date of purchase of brand new, unused products by the first end user. Please retain your sales receipt (or your warranty certificate) as proof of purchase. Unless you submit proof of purchase, which will be verified by your local Sennheiser service partner, you will be obliged to pay for any repairs that are carried out. Proof of purchase must state the date of purchase and name of the product.

We shall satisfy our warranty obligations by remedying any material or manufacturing faults free of charge at our discretion either by repair or by exchanging individual parts or the entire appliance. Any defective parts removed from a product during the course of a warranty claim shall become the property of Sennheiser electronic GmbH & Co. KG.

The following cases are not covered by the above warranty:

- minor faults or deviations in the quality of a product which do not affect the product's value or fitness for its intended purpose
- any accessories supplied with the product
- rechargeable and disposable batteries (these products have a shorter service life, the length of which also depends on the frequency of use)
- faults resulting from improper use (e.g. operating errors, mechanical damage, incorrect operating voltage)
Proper use for the purposes of this warranty is defined as use of the product under the conditions stated in the instructions for use.
- faults due to wear and tear
- any modification of Sennheiser products effected by you or a third party, unless Sennheiser has given its prior written consent to the nature and extent of the modification
- faults due to force majeure
- faults of which the purchaser was already aware at the time of purchase

All warranty claims become void if the product is tampered with by unauthorised persons or repair shops.

Warranty claims can be enforced in any country throughout the world in which the statutory rights of the country concerned are not in conflict with our warranty regulations. No other warranty claims or claims over and above the rights stated in these terms and conditions will be accepted.

Consumers may be entitled to statutory rights in their own countries which are not restricted by these warranty terms and conditions, as the warranty is governed by the laws of the country in which the Sennheiser product was purchased by the consumer. The provisions of the UN Convention on the International Sale of Goods do not apply to this service.

If you wish to file a claim under the warranty, please send the product to your local service partner, together with accessories and proof of purchase.

An up-to-date list of all service partners of Sennheiser electronic GmbH & Co. KG worldwide are available on the internet at www.sennheiser.com.

The customer bears the risk of shipment. To avoid any damage in transit, please use the original packaging if possible.

This equipment is in compliance with the essential requirements and other relevant provisions of Directives 1999/5/EC, 2004/108/EU or 2006/95/EC. The declaration is available on the internet site at www.sennheiser.com.

Before putting the equipment into operation, please observe the respective country-specific regulations!

Batteries or rechargeable batteries



The supplied batteries or rechargeable batteries can be recycled. Please dispose of them as special waste or return them to your specialist dealer. In order to protect the environment, only dispose of exhausted batteries.

WEEE Declaration



Your Sennheiser product was developed and manufactured with high-quality materials and components which can be recycled and/or reused. This symbol indicates that electrical and electronic equipment must be disposed of separately from normal waste at the end of its operational lifetime. Please dispose of this product by bringing it to your local collection point or recycling centre for such equipment. This will help to protect the environment in which we all live.

Statements regarding FCC and industry Canada

This device complies with Part 15 of the FCC Rules and with RSS-210 of Industry Canada. Operation is subject to the following two conditions: (1) this device may not cause harmful interference, and (2) this device must accept any interference received, including interference that may cause undesired operation.

This equipment has been tested and found to comply with the limits for a Class B digital device, pursuant to Part 15 of the FCC Rules. These limits are designed to provide reasonable protection against harmful interference in a residential installation. This equipment generates, uses and can radiate radio frequency energy and, if not installed and used in accordance with the instructions, may cause harmful interference to radio communications. However, there is no guarantee that interference will not occur in a particular installation. If this equipment does cause harmful interference to radio or television reception, which can be determined by turning the equipment off and on, the user is encouraged to try to correct the interference by one or more of the following measures:

- Reorient or relocate the receiving antenna.
- Increase the separation between the equipment and receiver.
- Connect the equipment into an outlet on a circuit different from that to which the receiver is connected.
- Consult the dealer or an experienced radio/TV technician for help.

This class B digital apparatus complies with the Canadian ICES-003

Changes or modifications made to this equipment not expressly approved by Sennheiser electronic Corp. may void the FCC authorization to operate this equipment.



Sennheiser electronic GmbH & Co. KG
Am Labor 1
30900 Wedemark, Germany
Phone +49 (5130) 600 0
Fax +49 (5130) 600 300
www.sennheiser.com

Printed in Germany
Publ. 03/08
524170/A01