



evolution wireless G4 sk 300

Instruction Manual



SK 300 G4 bodypack transmitter



You can find more detailed information about the SK 300 G4 in the following sections:

- Installation: “Installing the SK 300 G4”
- Operation: “Using the SK 300 G4”
- Technical Data: “SK 300 G4”



Headset and Lavalier microphones

We recommend using the following Lavalier microphones and headset microphones with the SK 300 G4 and SK 500 G4 bodypack transmitters.

Microphone	Features	Article no.
ME 2-II	Lavalier microphone, omni-directional, black	507437
ME 3-II	Headset microphone, cardioid, black	506295
ME 4-N	Lavalier microphone, cardioid, black	005020
MKE 1-ew	Lavalier microphone, omni-directional, black	502876
MKE 1-ew-3	Lavalier microphone, omni-directional, beige	502879
MKE 2-ew Gold	Lavalier microphone, omni-directional, black	009831
MKE 2 ew-3 Gold	Lavalier microphone, omni-directional, beige	009832
MKE 40-ew	Lavalier microphone, cardioid, black	500527
SL Headmic 1 BE	Headband microphone, omni-directional, beige	506272
SL Headmic 1 BK	Headband microphone, omni-directional, black	506271
SL Headmic 1 SB	Headband microphone, omni-directional, silver	506904

 You can find more information about the individual microphones on their respective product pages at www.sennheiser.com.

Line/instrument cables

The following cables are available to connect instruments and line sources to the SK 300 G4 and SK 500 G4 bodypack transmitters:

- **Sennheiser CL 2**
Line cable with XLR-3F plug on lockable 3.5 mm jack plug, article no. 004840
- **Sennheiser Ci 1-N**
Guitar cable with 6.3 mm jack plug on lockable 3.5 mm jack plug, article no. 005021



Rechargeable battery and charger

BA 2015 rechargeable battery

The BA 2015 rechargeable battery is designed for use with evolution wireless G4 series handheld transmitters, bodypack transmitters and bodypack receivers.

Article no. 009950



L 2015 charger

The BA 2015 rechargeable battery can be charged in the L 2015 charger on its own or inside of the bodypack transmitter/bodypack receiver.

Article no. 009828





LA 2 charging adapter

Charging adapter for L 2015 charger for charging SKM G4 handheld transmitters with installed BA 2015 rechargeable battery.

Article no. 503162



MUTE switch

- **RMS 1**, remote mute switch for SK 300 G4, article no. 503164





The frequency bank system

There are different frequency ranges in the UHF band available for transmission.

The following frequency ranges are available for the **ew 300-500 G4** series:

- **Aw+ range:** 470 – 558 MHz
- **AS range:** 520 – 558 MHz
- **Gw1 range:** 558 – 608 MHz
- **Gw range:** 558 – 626 MHz
- **GBw range:** 606 – 678 MHz
- **Bw range:** 526 – 698 MHz
- **Cw range:** 718 – 790 MHz
- **Dw range:** 790 – 865 MHz
- **JB range:** 806 – 810 MHz
- **K+ range:** 925 – 937.5 MHz

Every frequency range has **26 frequency banks** with up to 32 channels:

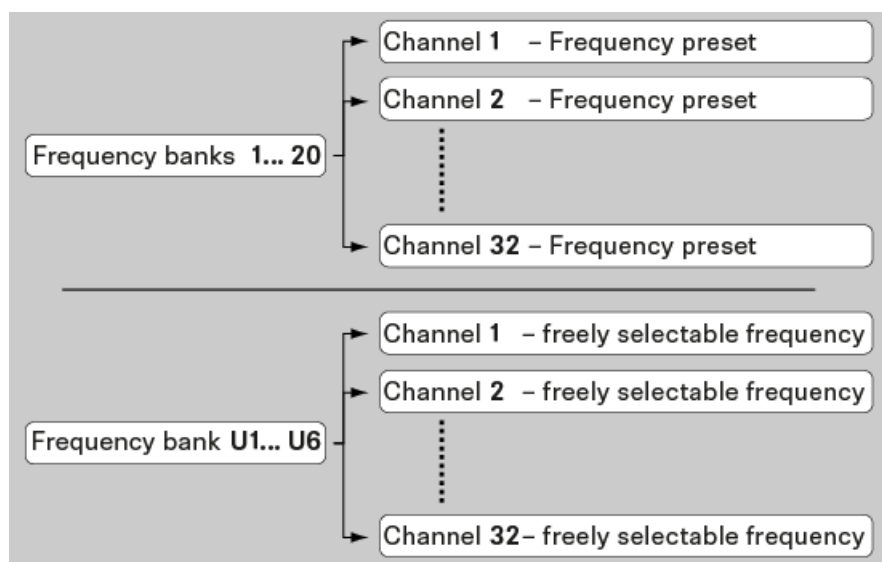

i You can find information about the frequency presets in the frequency tables of the respective frequency ranges under “Frequency tables”.



Installing the SK 300 G4

These sections contain detailed information about installing and starting up the SK 300 G4.

You can find information about operating the SK 300 G4 under “Using the SK 300 G4”.

Inserting and removing the batteries/rechargeable batteries

You can operate the bodypack transmitter either with batteries (AA, 1.5 V) or with the rechargeable Sennheiser BA 2015 battery.

- ▷ Press the two catches and open the battery compartment cover.
- ▷ Insert the batteries or the rechargeable battery as shown below. Please observe correct polarity when inserting the batteries.









- ▷ Close the battery compartment.
The cover locks into place with an audible click.



Battery status

Charge status of the batteries:

	100 %	> 8 h
	70 %	4 - 6 h
	30 %	2 - 3 h
LOW BATT    ... 		

Charge status is critical (LOW BATT):





Connecting a microphone to the SK 300 G4

You can find a list of recommended Lavalier and headset microphones for the bodypack transmitter under “Microphones and cables”.

To connect a microphone to the bodypack transmitter:

- ▷ Insert the cable’s 3.5 mm jack plug into the **MIC/LINE** socket on the bodypack transmitter as shown in the diagram.
- ▷ Screw the plug’s coupling ring onto the audio socket thread of the bodypack transmitter.





Connecting an instrument or line source to the SK 300 G4

You can connect instruments or audio sources with a line level to the bodypack transmitter.

To do this, you will need the **Ci 1-N** (6.3 mm jack plug on a lockable 3.5 mm jack plug) or **CL 2** (XLR-3F plug on lockable 3.5 mm jack plug) Sennheiser cables.

To connect an instrument or line source to bodypack transmitter:

- ▷ Insert the cable's 3.5 mm jack plug into the **MIC/LINE** socket on the bodypack transmitter as shown in the diagram.
- ▷ Screw the plug's coupling ring onto the audio socket thread of the bodypack transmitter.





Connecting the RMS 1 mute switch to the SK 300

You can control the SK 300 G4 remotely via cable with the RMS 1 remote mute switch.



1 MIC button

- See “Using the SK 300 G4 with the RMS 1 remote mute switch”

2 STATUS LED

- See “Advanced > MIC LED menu item”

3 2.5 mm jack plug

To connect the RMS 1 to the SK 300 G4:

- ▷ Insert the 2.5 mm jack plug of the RMS 1 into the 2.5 mm jack socket of the SK 300.

This deactivates the function of the **MUTE** switch of the SK 300 G4.



You can find information about operating the RMS 1 under “Using the SK 300 G4 with the RMS 1 remote mute switch”.



Attaching the bodypack transmitter to clothing

You can use the belt clip to attach the bodypack transmitter to your waistband or on a guitar strap.

The belt clip is detachable so that you can also attach the bodypack transmitter with the antenna pointing downwards. To do so, withdraw the belt clip from its fixing points and attach it the other way round.

The belt clip is secured so that it cannot slide out of its fixing points accidentally.



To detach the belt clip:

- ▷ Lift the belt clip as shown in the diagram.
- ▷ Press one side of the clip downward on the fixing hole and pull it out of the transmitter housing.
- ▷ Do the same thing on the other side.

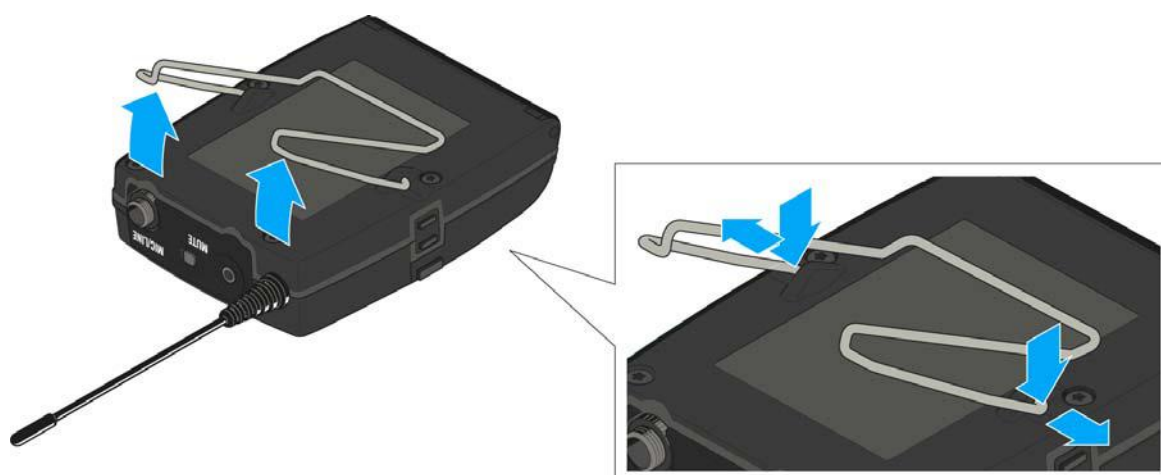



Using the SK 300 G4

These sections contain detailed information about using the SK 300 G4.

You can find information about installing the SK 300 under “Installing the SK 300 G4”.

Operating elements of the SK 300 G4 bodypack transmitter

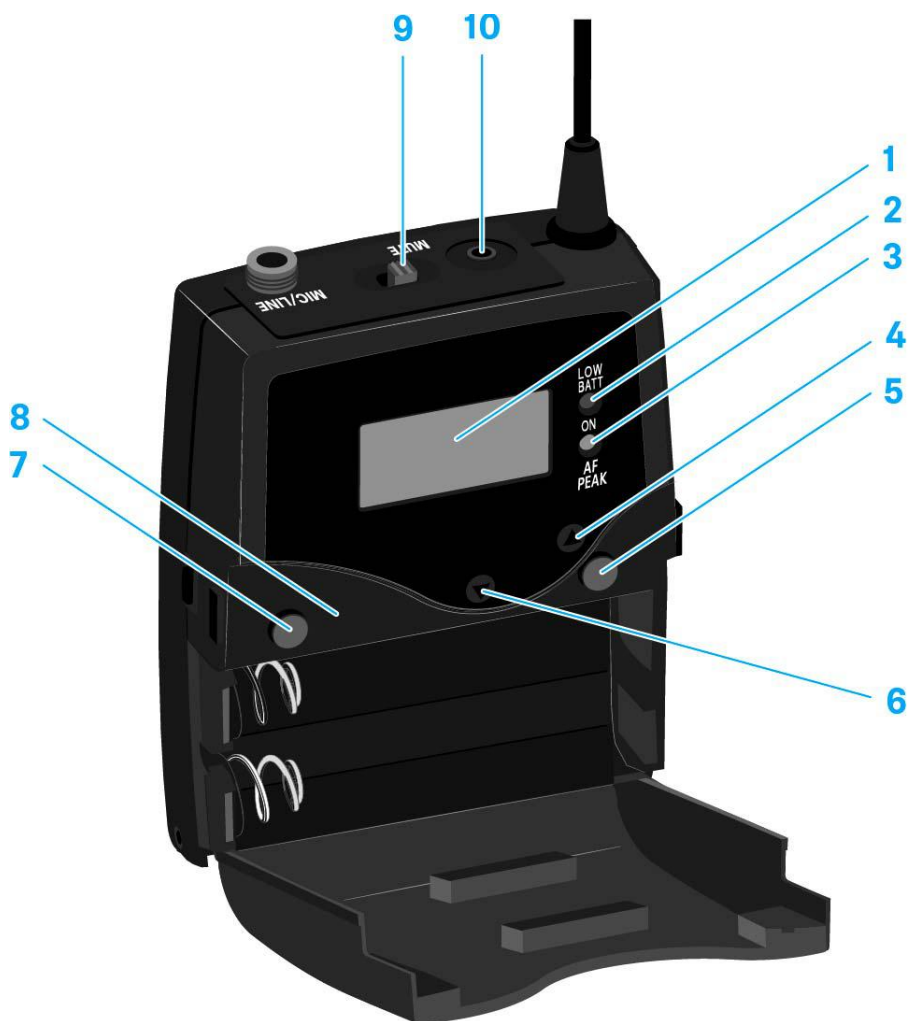

- 1** Display panel
 - See “Displays on the SK 300 G4 bodypack transmitter display panel”
- 2** Operation and battery indicator, red LED
 - illuminated = ON
See “Switching the SK 300 G4 bodypack transmitter on and off”
 - flashing = LOW BATTERY
See “Inserting and removing the batteries/rechargeable batteries”
- 3** Audio overload indicator, yellow LED
 - illuminated = AF PEAK (overload)
See “Sensitivity menu item”



- 4 UP** button
 - See “Buttons for navigating the SK 300 G4 menu”
- 5 SET** button
 - See “Buttons for navigating the SK 300 G4 menu”
- 6 DOWN** button
 - See “Buttons for navigating the SK 300 G4 menu”
- 7 ON/OFF** button with ESC function in the operating menu
 - Switch the transmitter on or off
See “Switching the SK 300 G4 bodypack transmitter on and off”
 - Escape function in the menu
See “Buttons for navigating the SK 300 G4 menu”
- 8** Infra-red interface
 - See “Synchronizing devices”
- 9 MUTE** switch
 - Deactivate and activate RF signal
See “Deactivating the RF signal (RF mute)”
 - Deactivate and activate audio signal
See “Muting the bodypack transmitter (AF mute)”
- 10** 2.5 mm jack socket
 - for remote mute switch RMS 1
 - See “Connecting the RMS 1 mute switch to the SK 300”



Switching the SK 300 G4 bodypack transmitter on and off

- Press the two catches and open the battery compartment cover.

To switch on the SK 300 G4:

- Hold down the **ON/OFF** button until the Sennheiser logo appears on the display.

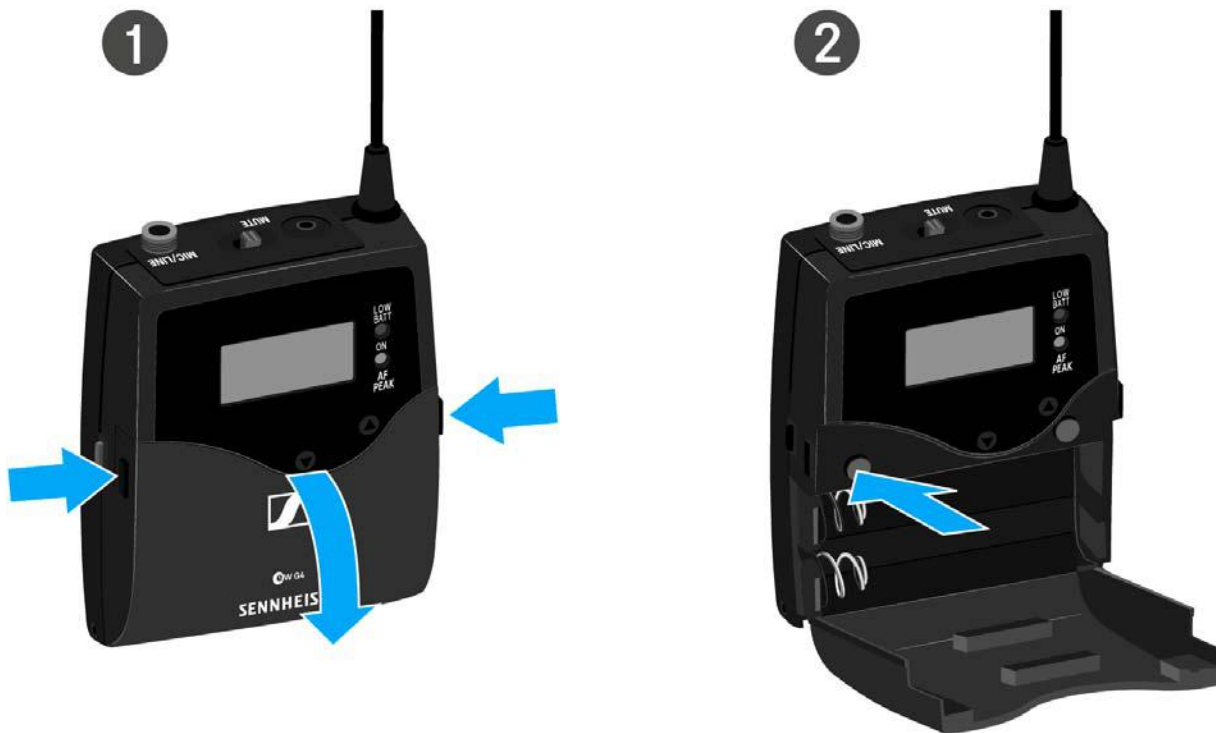

To switch off the SK 300 G4:

- Hold down the **ON/OFF** button until the display goes off.



Muting the bodypack transmitter (AF mute)

You can mute the audio signal in two ways:

Muting the audio signal with the **MUTE** switch

You can mute the audio signal with the **MUTE** switch.

To do this, the **MUTE** switch function must be configured to **AF On/Off**. You can find more information about this subject under “Advanced > Mute Mode menu item”.



- ▷ Slide the **MUTE** switch to the **MUTE** position.
The audio signal is muted. The message **MUTE** is shown on the display.

Muting the audio signal with the **RMS 1** remote mute switch

See “Using the SK 300 G4 with the RMS 1 remote mute switch”



Deactivating the RF signal (RF mute)

You can deactivate the RF signal in three ways:

Deactivating the RF signal with the **MUTE** switch

You can deactivate the RF signal with the MUTE switch.

To do this, the MUTE switch function must be configured to RF On/Off. You can find more information about this subject under “Advanced > Mute Mode menu item”.



Slide the **MUTE** switch to the **MUTE** position.

The RF signal is deactivated. The message **MUTE** is shown in the display and the transmission icon no longer appears.





Deactivating the RF signal with the **ON/OFF** button

You can deactivate the RF signal with the ON/OFF button.

To deactivate the RF signal:

- ▷ Short-press the **ON/OFF** button.

RF Mute On? appears.

- ▷ Press the **SET** button.

The RF signal is deactivated. The message **MUTE** is shown in the display and the transmission icon no longer appears.



To activate the RF signal:

- ▷ Short-press the **ON/OFF** button.

RF Mute Off? appears.

- ▷ Press the **SET** button.

The transmission icon appears again.

Deactivating the RF signal with the **RMS 1** remote mute switch

See “Using the SK 300 G4 with the RMS 1 remote mute switch”



Using the SK 300 G4 with the RMS 1 remote mute switch

You can control the SK 300 G4 remotely via cable with the RMS 1 remote mute switch.

- ▷ Configure the desired function for the RMS 1 in the “Advanced > Mute Mode menu item” of the SK 300.
- ▷ Press the **MIC** button.

The bodypack transmitter will behave as described in the table in “Advanced > Mute Mode menu item”.





Lock-off function

You can set the automatic lock-off function in the **Auto lock** menu (see “Auto Lock menu item”).

When you have switched on the lock-off function, you will have to turn the transmitter off and on again in order to operate it.

To temporarily deactivate the lock-off function:

- ▷ Press the **SET** button.
Locked appears in the display panel.
- ▷ Press the **UP** or **DOWN** button.
Unlock? appears in the display panel.
- ▷ Press the **SET** button.
Lock-off function is now temporarily deactivated.

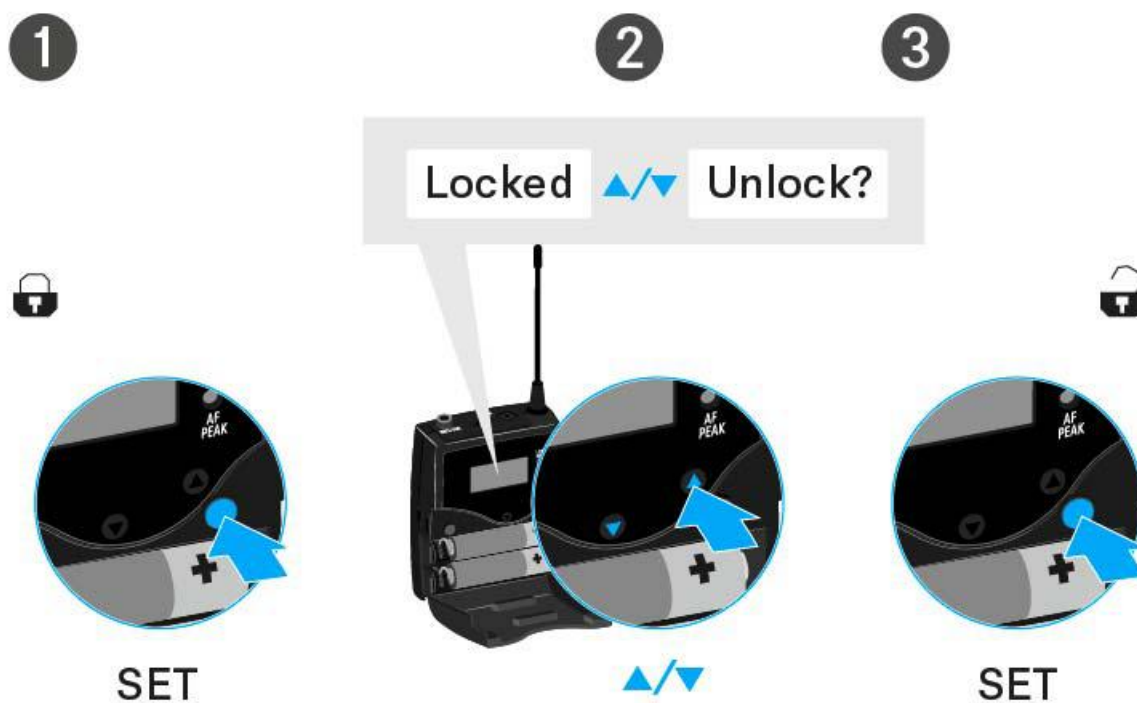



Displays on the SK 300 G4 bodypack transmitter display panel

You can view the following information on the transmitter display.

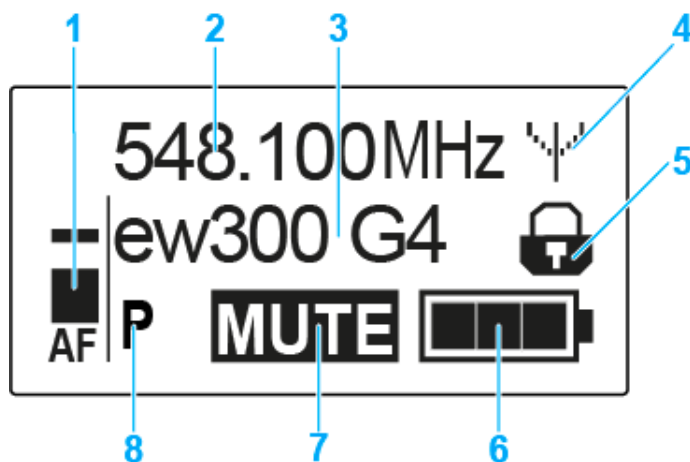

- 1 AF audio level**
 - Displays the audio level with peak hold function
 - See “Sensitivity menu item”
- 2 Frequency**
 - Configured transmission frequency
 - See “Frequency Preset menu item”
- 3 Name**
 - Freely selectable name of the receiver
 - See “Name menu item”
- 4 Transmission icon**
 - RF signal is being transmitted
 - See “Muting the bodypack transmitter (AF mute)”
- 5 Lock-off function**
 - Lock-off function is activated
 - See “Auto Lock menu item”
- 6 Battery status**
 - See “Battery status”
- 7 MUTE muting function**
 - The audio signal is muted
 - See “Muting the bodypack transmitter (AF mute)”
- 8 P pilot tone**
 - Pilot tone transmission is activated
 - See “Advanced > Pilot Tone menu item”

>> “Buttons for navigating the SK 300 G4 menu”

>> “Setting options in the menu”



Select a standard display

- ▷ Press the **UP** or **DOWN** buttons to select a standard display.

Frequency/Name standard display



Channel/Frequency standard display



Name/Channel standard display





Buttons for navigating the SK 300 G4 menu

Navigating through the menu

To open the menu:

- ▷ Press the **SET** button.
The operating menu is shown on the transmitter display panel.

To open a menu item:

- ▷ Press the **UP** or **DOWN** buttons to navigate through the individual menu items.
- ▷ Press the **SET** button to open the selected menu item.

 “Operating elements of the SK 300 G4 bodypack transmitter”

Making changes in a menu item

After you open a menu item, you can make changes as follows:

- ▷ Press the **UP** or **DOWN** buttons to set the displayed value.
- ▷ Press the **SET** button to save the setting.
- ▷ Press the **ESC (ON/OFF)** button to leave the menu item without saving the setting.

 “Operating elements of the SK 300 G4 bodypack transmitter”

>> “Displays on the SK 300 G4 bodypack transmitter display panel”

>> “Setting options in the menu”



Sensitivity menu item

- Adjusting the input sensitivity – **AF** audio level

Setting range: 0 dB to –60 dB in 3 dB steps

The **AF** audio level is also displayed when the bodypack transmitter is muted, e.g. to check the sensitivity before a live broadcast.

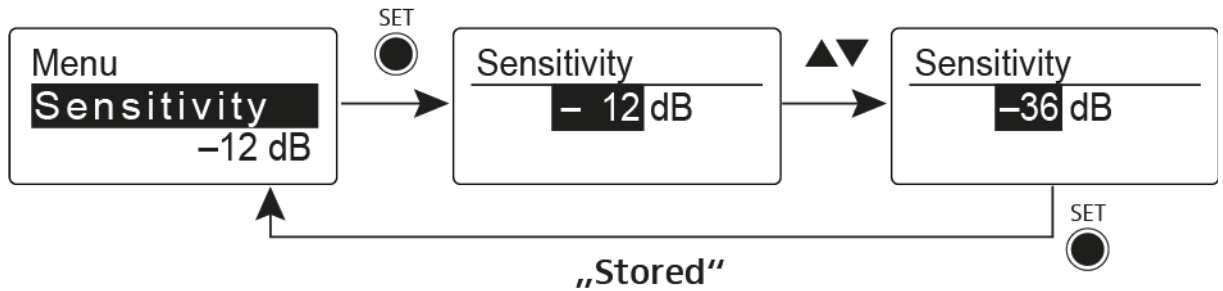

Recommended presets:

- Loud music/vocals: –30 to –21 dB
- Moderation: –21 to 0 dB
- Instrument input
 - Electric guitar with single-coil pickup: –30 to –24 dB
 - Electric guitar with Humbucker pickups: –45 to –30 dB
 - Guitars with active electronics (active pickups, active EQs, Piezo pickups) –45 to –30 dB

Frequency Preset menu item

- Manually selecting a frequency bank and channel

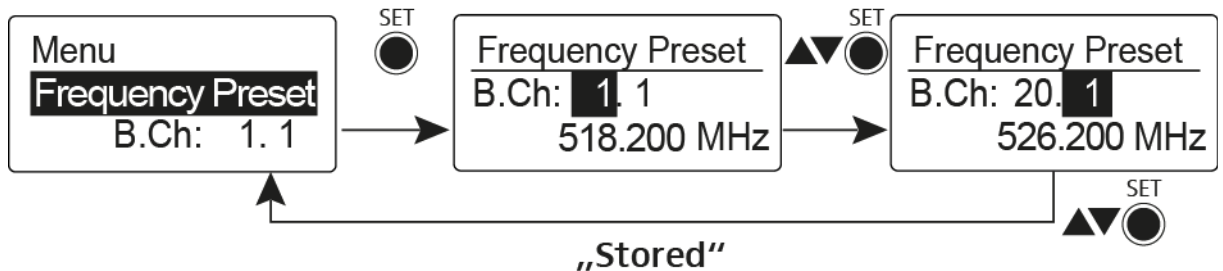

i While you work in the **Frequency Preset** menu, the RF signal is deactivated.

Please note when creating multi-channel systems:

Only the factory-preset frequencies within one frequency bank are intermodulation-free. The bodypack transmitter and receiver must be set to the same frequency. Be sure to note the information on frequency selection under “Establishing a radio link”.



Name menu item

- Entering names

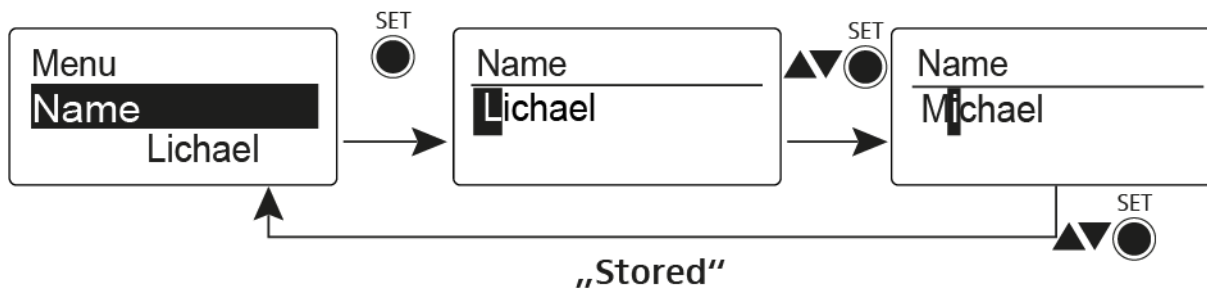

In the **Name** menu item you can enter any name you want for the bodypack transmitters (e.g. the names of the musicians).

The name can be shown in the [Frequency/Name](#) and [Name/Channel](#) standard displays.

The names are a maximum of 8 characters:

- All letters except umlauts.
- Numbers from 0 to 9
- Special characters and spaces

Enter the names as follows:

- ▷ Press the UP or DOWN buttons to select a character.
- ▷ Press the UP or DOWN buttons to switch to the next space or to save the name you have entered once it is complete.

Auto Lock menu item

- Switching the automatic lock-off function on and off

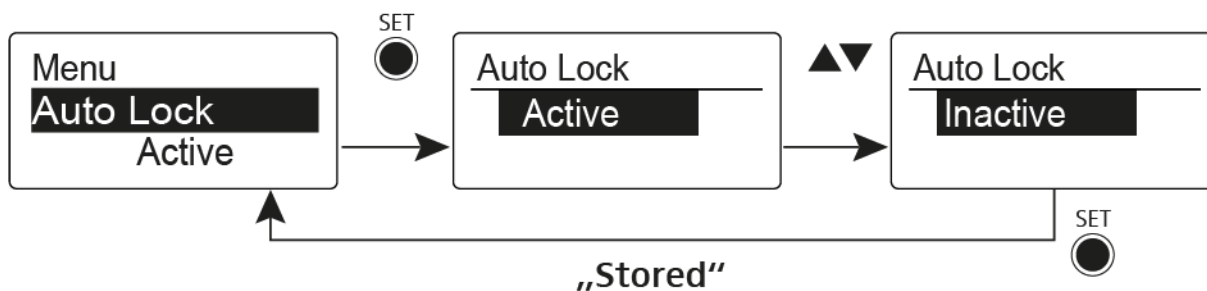

This lock prevents the bodypack transmitter from being unintentionally switched off and also prevents any unintentional changes to the transmitter's configuration. In the current standard display, the lock icon shows whether the lock-off function is currently switched on.

You can find information about using the lock-off function under "Lock-off function".



Advanced > Tune menu item

- Configuring the transmission frequency and frequency bank U

When you have configured the bodypack transmitter to a system bank and you call up the **Tune** menu item, channel 1 of the frequency bank **U** is automatically set. The message **U.1** briefly appears in the display. In the factory settings, the channels of the frequency bank **U** are not assigned to any transmission frequency.

While you work in the **Tune** menu, the RF signal is deactivated.

You can configure a transmission frequency for the current channel or select a channel in the frequency bank **U** and configure a transmission frequency for this channel in the **Tune** menu. Be sure to note the information on frequency selection under “Setting notes”.

Only adjusting the frequency

To configure the transmission frequency for the current channel:

- ▷ Press the UP or DOWN button until the **Tune** menu item appears.
- ▷ Press the SET button.

The frequency selection appears.

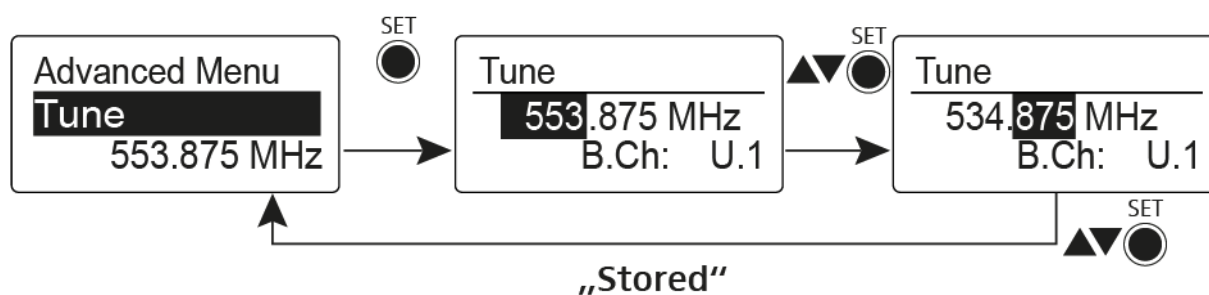

- ▷ Configure the desired frequency.
 - ▷ Press the SET button.
- Your settings will be saved. You are now back in the operating menu.

Setting the channel and frequency

To select a channel and assign it a frequency:

- ▷ Press the UP or DOWN button until the **Tune** menu item appears.
- ▷ Hold down the SET button until the power LED turns off.

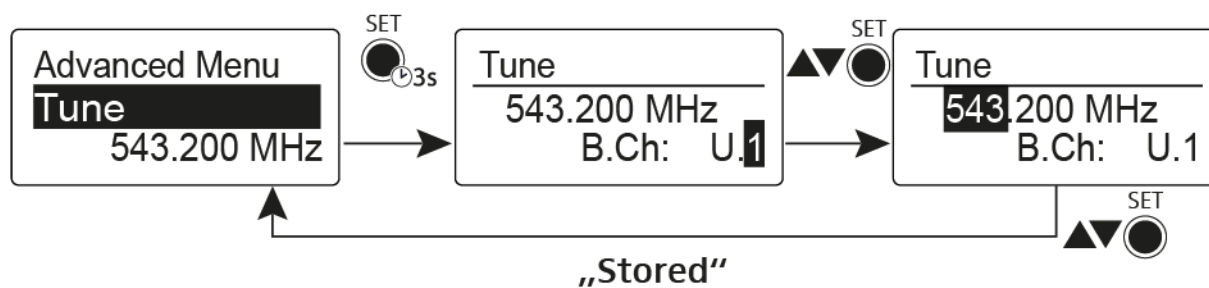

- ▷ Set the desired channel.
 - ▷ Press the SET button.
- The frequency selection appears.
- ▷ Configure the frequency.



Advanced > Mute Mode menu item

- Configure the function of the mute switch and the **RMS 1** remote mute switch

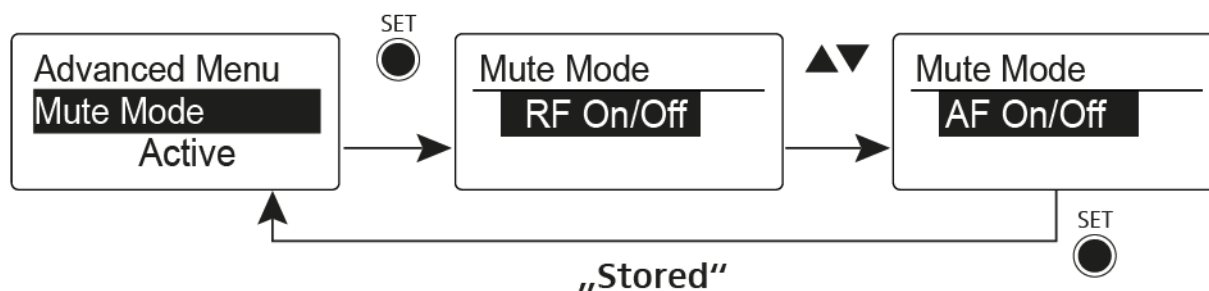

i The **Push to mute** and **Push to talk** menu items can only be used with an RMS 1 remote mute switch.

MUTE switch functions

AF On/Off mode

- If set to position **MUTE**, the audio signal is muted

RF On/Off mode

- If set to the **MUTE** selector position, the RF signal is deactivated.

Disabled mode

- No function

Functions of the RMS 1 remote mute switch

AF On/Off mode

- Press the RMS 1 mute switch: The audio signal is muted.
- Press the RMS 1 mute switch again: The audio signal is no longer muted.

RF On/Off mode

- Press the RMS 1 mute switch: The RF signal is deactivated.
- Press the RMS 1 mute switch again: The RF signal is activated.

Push To Mute mode

- The audio signal is deactivated as long as the RMS 1 mute switch is pressed.

Push To Talk mode

- The audio signal is activated as long as the RMS 1 mute switch is pressed.
- The bodypack transmitter is muted when you configure the **Push to Talk** function.

Disabled mode

- No function

i When you connect the RMS 1 remote mute switch you can only mute the signal using this switch. The **MUTE** switch's function is deactivated during this time.



Advanced > MIC LED menu item

- Configure the **STATUS** LED of the RMS 1 remote mute switch

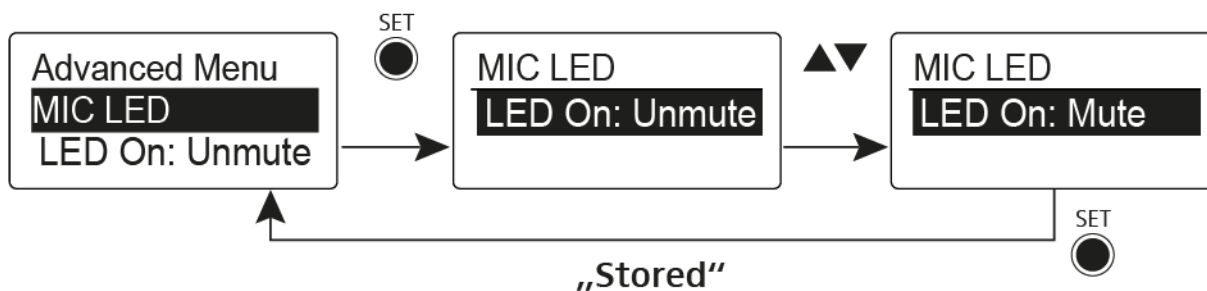

In the **MIC LED** menu item you can configure and deactivate the **STATUS** LED (see “Connecting the RMS 1 mute switch to the SK 300”) of the RMS 1 remote mute switch regardless of the settings of the “Advanced > Mute Mode menu item” and the status of the RF signal.

LED On: [setting Unmute](#)

- The **STATUS** LED is illuminated when the bodypack transmitter is sending an RF signal or is not muted.

LED On: [setting Mute](#)

- The **STATUS** LED is illuminated when the bodypack transmitter is not sending an RF signal or is muted.

Disable LED [setting](#)

- The **STATUS** LED is deactivated.



Advanced > RF Power menu item

- Configuring the transmission power

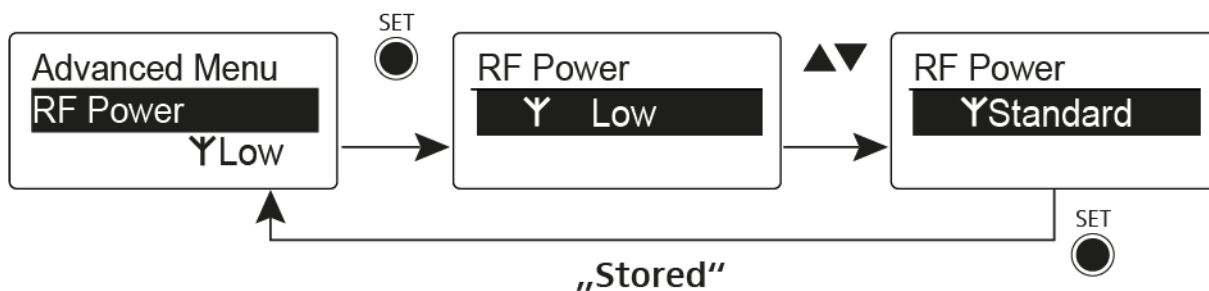

You can configure the transmission power in three steps in the **RF Power** menu item. Please note the information at the following address:

General conditions and restrictions for the use of frequencies

Setting range:

Low: 10 mW

Standard: 30 mW

High: 50 mW

Advanced > Pilot Tone menu item

- Activating/deactivating pilot tone transmission

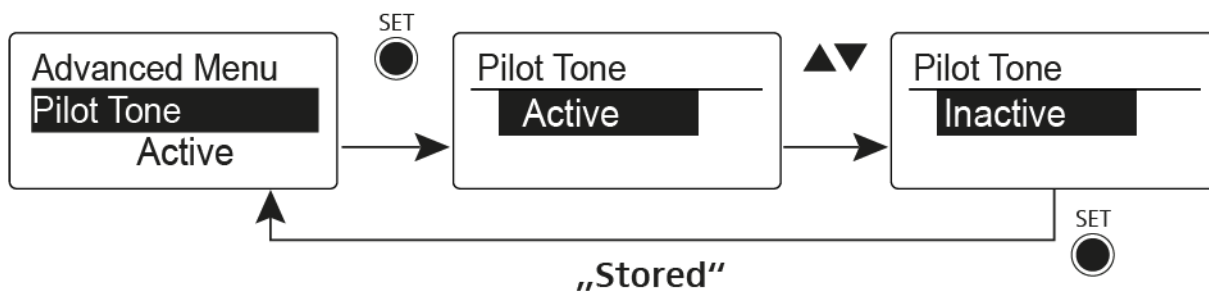

The pilot tone has an inaudible frequency that is sent from the transmitter and evaluated by the receiver. It supports the receiver's squelch function.



Advanced > LCD Contrast menu item

- Adjusting the contrast of the display panel

You can configure the contrast of the display in 16 steps.

Advanced > Reset menu item

- Resetting the bodypack transmitter

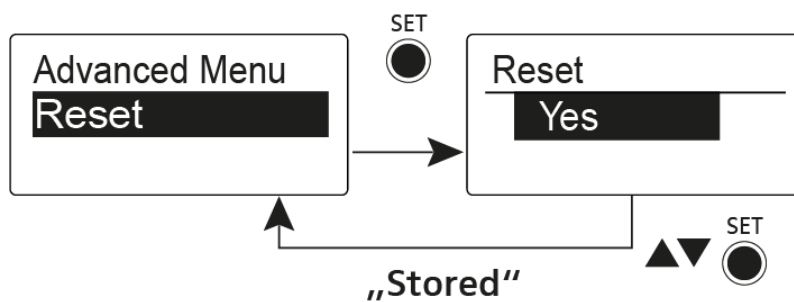

When you reset the bodypack transmitter, only the selected settings of the pilot tone and the **U1** to **U6** frequency banks are retained.

Advanced > Software Revision menu item

- Show software revision

You can display the current software revision.



SK 300 G4 product variants

Made in Germany

SK 300 G4-RC-K+	925 – 937.5 MHz	Art. no. 507719
SK 300 G4-RC-GBw	606 – 678 MHz	Art. no. 507720
SK 300 G4-RC-Gw	558 – 626 MHz	Art. no. 507721
SK 300 G4-RC-Bw	626 – 698 MHz	Art. no. 507722
SK 300 G4-RC-Cw	718 – 790 MHz	Art. no. 507723
SK 300 G4-RC-Dw	790 – 865 MHz	Art. no. 507724
SK 300 G4-RC-Aw+	470 – 558 MHz	Art. no. 508406

Assembled in the USA

SK 300 G4-RC-AS	520 – 558 MHz	Art. no. 508059
SK 300 G4-RC-JB	806 – 810 MHz	Art. no. 508060
SK 300 G4-RC-Gw	558 – 626 MHz	Art. no. 508061
SK 300 G4-RC-Bw	626 – 698 MHz	Art. no. 508062
SK 300 G4-RC-Cw	718 – 790 MHz	Art. no. 508063
SK 300 G4-RC-Dw	790 – 865 MHz	Art. no. 508064
SK 300 G4-RC-Aw+	470 – 558 MHz	Art. no. 508427
SK 300 G4-RC-Gw1	558 – 608 MHz	Art. no. 508448



SK 300 G4

RF characteristics

Modulation	Wideband FM
Receiving frequency ranges	Aw+: 470 – 558 MHz AS: 520 – 558 MHz Gw1: 558 – 608 MHz Gw: 558 – 626 MHz GBw: 606 – 678 MHz Bw: 526 – 698 MHz Cw: 718 – 790 MHz Dw: 790 – 865 MHz JB: 806 – 810 MHz K+: 925 – 937.5 MHz
Transmission frequencies	Max 2880 receiving frequencies, adjustable in 25 kHz steps 20 frequency banks, each with up to 32 factory-preset channels, no intermodulation 6 frequency banks with up to 32 programmable channels
Switching bandwidth	up to 88 MHz
Nominal/peak deviation	± 24 kHz / ± 48 kHz
Frequency stability	$\leq \pm 15$ ppm
RF output power at 50 ?	Switchable: Low: typically 10 mW Standard: typically 30 mW High: typically 50 mW
Pilot tone squelch	Can be switched off



AF characteristics

Compander system	Sennheiser HDX
AF frequency response	Microphone: 80 – 18,000 Hz Line: 25 – 18,000 Hz
Signal-to-noise ratio (1 mV, peak deviation)	≥ 115 dBA
Total harmonic distortion (THD)	≤ 0.9 %
Max. input voltage Microphone/line	3 V _{eff}
Input impedance Microphone/line	40 kΩ, unbalanced/1 MΩ
Input capacitance	Switchable
Setting range for input sensitivity	60 dB in 3 dB steps

Overall device

Temperature range	-10 °C to +55 °C (14 °F to 131 °F)
Power supply	2 AA batteries, 1.5 V or BA 2015 accupack
Nominal voltage	3 V battery 2.4 V rechargeable battery
Power consumption	
at nominal voltage with transmitter switched off	typically 180 mA ≤ 25 μA
Operating time	Typically 8 h
Dimensions	approx. 82 x 64 x 24 mm
Weight (with batteries)	Approx. 160 g



Pin assignment

3.5 mm stereo jack plug

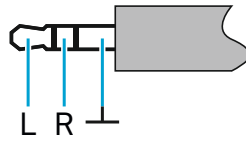

- Plug for headphone and earphone cables, e.g. IE 4.
- Connect to:
 - EK IEM G4
 - EK 500 G4

3.5 mm mic jack plug

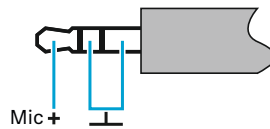

- Plug for lavalier and headset microphone, e.g. ME 2.
- Connect to:
 - SK 100 G4
 - SK 300 G4
 - SK 500 G4

3.5 mm line jack plug

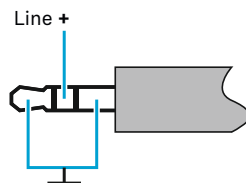

- Plug for line and instrument cables, e.g. Ci 1-N
- Connect to:
 - SK 100 G4
 - SK 300 G4
 - SK 500 G4

6.3 mm stereo jack plug, balanced (audio in/loop out)

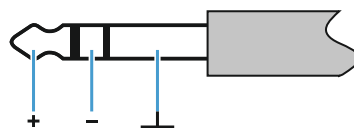

- Connect to:
 - SR IEM G4 Audio In
 - SR IEM G4 Loop Out



CONTACT

Contact

Instruction manual as a PDF

You can find this instruction manual as a PDF (German and English) in the download section of the Sennheiser website at **www.sennheiser.com/download**.

Download area for the Sennheiser website

- ▷ Enter **ew G4** into the search bar to show the instruction manuals for products in the ew G4 series.

Customer service

If you have technical questions or experience problems with the product, you can access Sennheiser customer service at **www.sennheiser.com/service-support**.

Sennheiser customer service online area

Feedback

Do you have any questions or suggestions about this instruction manual? Write to us at **techcomm@sennheiser.com**.



Sennheiser electronic GmbH & Co. KG

Am Labor 1, 30900 Wedemark, Germany
www.sennheiser.com