



SKM 2000

Instruction manual

Contents

Important safety instructions	2
The SKM 2000 radio microphone	3
Areas of application	3
The frequency bank system	4
Delivery includes	5
Product overview	6
Overview of the SKM 2000 radio microphone	6
Overview of the displays	7
Putting the radio microphone into operation	8
Inserting the batteries/accupack	8
Charging the accupack	9
Changing the microphone head	10
Changing the color-coded protection ring	11
Using the radio microphone	11
Switching the radio microphone on/off	12
Deactivating the lock mode temporarily	13
Deactivating the RF signal	14
Selecting a standard display	14
Using the operating menu	15
The buttons	15
Overview of the operating menu	15
Working with the operating menu	17
Synchronizing the radio microphone with a receiver	19
Cleaning the radio microphone	20
If a problem occurs	21
Specifications	22



For more detailed information on the individual sections of this instruction manual, visit the corresponding product page on our website at www.sennheiser.com.

Important safety instructions

- Read this instruction manual.
- Keep this instruction manual. Always include this instruction manual when passing the device on to third parties.
- Heed all warnings and follow all instructions.
- Clean the device only with a slightly damp cloth.
- Do not place the device near any heat sources such as radiators, stoves, or other devices (including amplifiers) that produce heat.
- Only use attachments/accessories specified by Sennheiser.
- When replacement parts are required, only use replacement parts specified by Sennheiser or those having the same characteristics as the original part. Unauthorized substitutions may result in fire, electric shock, or other hazards.
- Refer all servicing to qualified service personnel.
Servicing is required if the device has been damaged in any way, liquid has been spilled, objects have fallen inside, the device has been exposed to rain or moisture, does not operate properly or has been dropped.
- **WARNING:** To reduce the risk of short circuits, do not use the device near water and do not expose it to rain or moisture.

Intended use

Intended use of the SKM 2000 radio microphone includes:

- having read these instructions especially the chapter “Important safety instructions”,
- using the device within the operating conditions and limitations described in this instruction manual.

“Improper use” means using the device other than as described in these instructions, or under operating conditions which differ from those described herein.

The SKM 2000 radio microphone

This radio microphone is part of the 2000 series. With this series, Sennheiser offers high-quality state-of-the-art RF transmission systems with a high level of operational reliability and ease of use. Transmitters and receivers permit wireless transmission with studio-quality sound.

Features of the 2000 series:

- Optimized PLL synthesizer and microprocessor technology
- **HDX** noise reduction system
- Pilot tone squelch control
- True diversity technology
- Switching bandwidth of up to 75 MHz
- Increased immunity to intermodulation and interferences in multi-channel operation

Areas of application

The radio microphone can be combined with the EM 2000 or EM 2050 rack-mount receiver. The receivers are available in the same UHF frequency ranges and are equipped with the same frequency bank system with factory-preset frequencies. An advantage of the factory-preset frequencies is that

- a transmission system is ready for immediate use after switch-on,
- several transmission systems can be operated simultaneously on the preset frequencies without causing intermodulation interference.

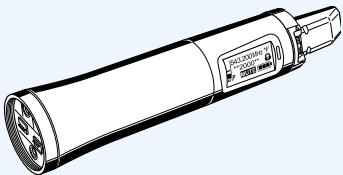
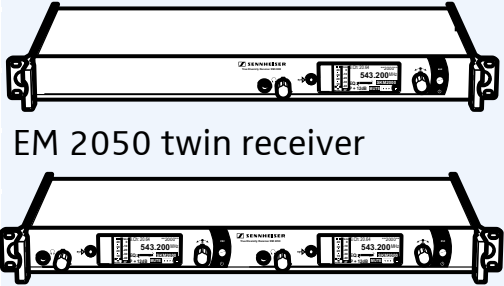
Radio microphone	Interchangeable microphone heads	Receivers
 <p>SKM 2000</p> <p>BK (black)</p> <p>NI (nickel)</p>	MMD 835-1	EM 2000 receiver
	MMD 845-1	 <p>EM 2050 twin receiver</p>
	MME 865-1	
	MMD 935-1	
	MMD 945-1	
	MMK 965-1	
	MD 9235	

The frequency bank system

The radio microphone is available in 5 UHF frequency ranges with up to 3,000 transmission frequencies per frequency range:

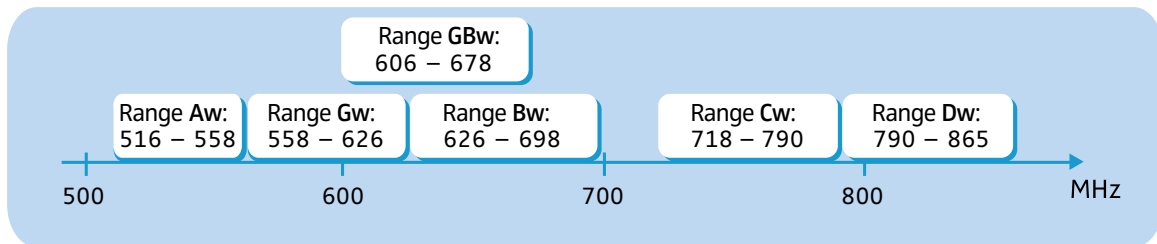

Each frequency range (Aw–Dw, Gw, GBw) offers 26 frequency banks with up to 64 channels each:

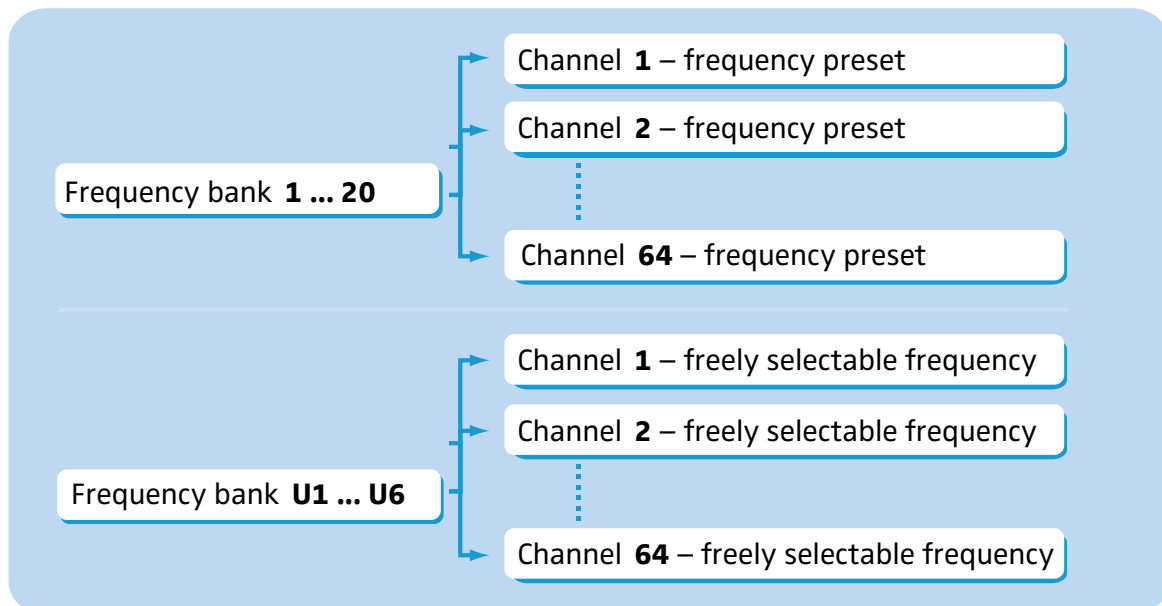

Each of the channels in the frequency banks "1" to "20" has been factory-preset to a fixed transmission frequency (frequency preset). The factory-preset frequencies within one frequency bank are intermodulation-free. These frequencies cannot be changed.

For an overview of the frequency presets, please refer to the supplied frequency information sheet. Updated versions of the frequency information sheet can be downloaded from the corresponding product page on our website at www.sennheiser.com.

The frequency banks "U1" to "U6" allow you to freely select and store transmission frequencies. It might be that these transmission frequencies are **not** intermodulation-free.

Delivery includes

The packaging contains the following items:

- 1 SKM 2000 radio microphone
- 2 AA size batteries, 1.5 V
- 1 microphone clamp
- 8 color-coded identification rings
- 1 pouch
- 1 instruction manual
- 1 frequency information sheet
- 1 RF power information sheet

You additionally require 1 microphone head.

Product overview

Overview of the SKM 2000 radio microphone

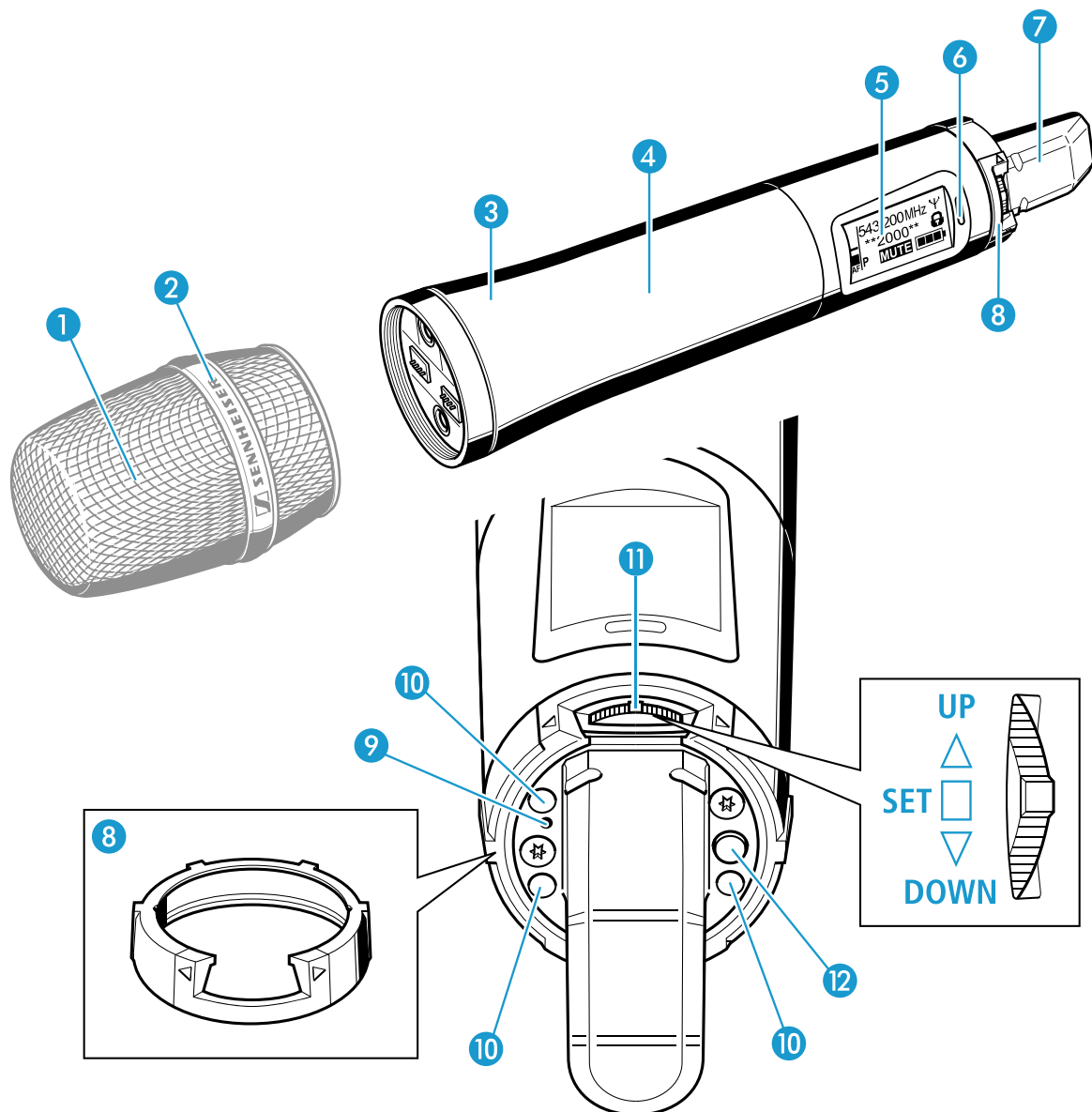



- 1 Microphone head (interchangeable)
- 2 Name and pick-up pattern of the microphone head
- 3 Body of radio microphone
- 4 Battery compartment (not visible from outside)
- 5 Display panel, backlit in orange
- 6 Infra-red interface
- 7 Antenna
- 8 Color-coded protection ring; (available in different colors)
- 9 Operation and battery status indicator, red LED:
lit = ON
flashing = LOW BATT
- 10 Charging contacts
- 11 Multi-function switch:
▲ (UP)
▼ (DOWN)
■ (SET)
- 12 ON/OFF button (serves as the ESC (cancel) key in the operating menu)

Overview of the displays

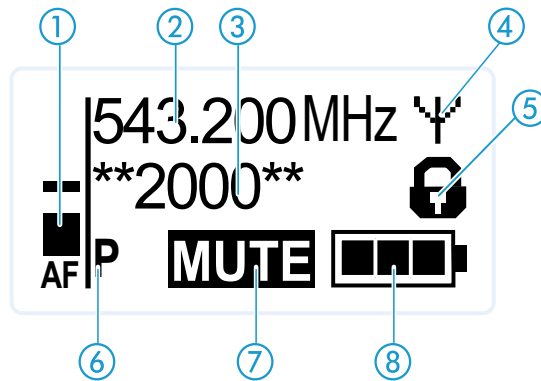
After switch-on, the radio microphone displays the standard display “Frequency/Name”. For further illustrations and examples of the different standard displays, refer to Seite 14. The display backlighting is automatically reduced after approx. 20 seconds.

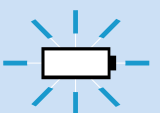
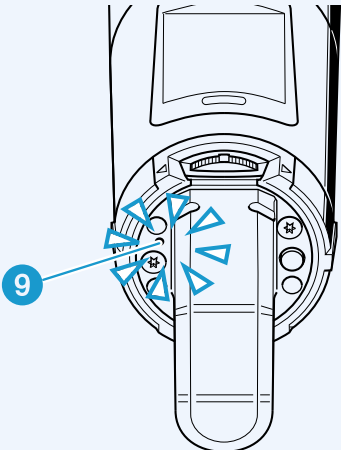

Display	Meaning
① Audio level “AF”	Modulation of the radio microphone with peak hold function
② Frequency	Current transmission frequency
③ Name	User selectable name
④ Transmission icon	RF signal is being transmitted
⑤ Lock mode icon	Lock mode is activated
⑥ “P” (Pilot)	Pilot tone transmission is activated
⑦ “MUTE”	Audio signal is muted
⑧ Battery status	Charge status:
	 approx. 100%
	 approx. 70%
	 approx. 30%
	 charge status is critical, the red LOW BATT LED ⑨ is flashing:
	

Putting the radio microphone into operation

Inserting the batteries/accupack

For powering the radio microphone, you can either use two 1.5 V AA size batteries or the rechargeable Sennheiser BA 2015 accupack.

- ▶ Unscrew the lower part of the radio microphone from the radio microphone's body 4 by turning it counterclockwise.

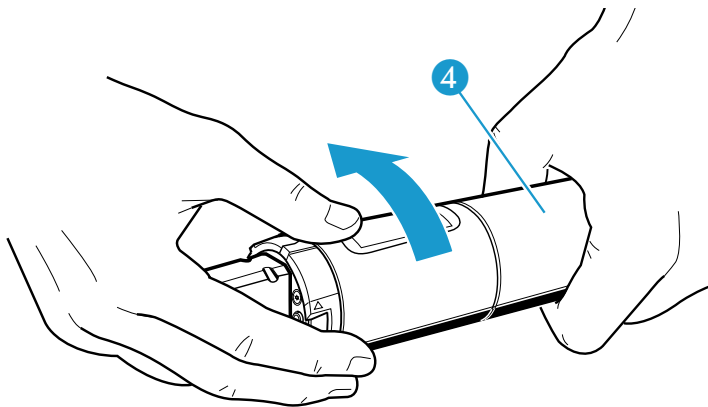

When unscrewing the radio microphone during operation, the muting function is automatically activated. "MUTE" appears on the display panel.

When screwing the lower part of the radio microphone back to the radio microphone's body, the muting is canceled.

- ▶ Slide back the lower part of the radio microphone as far as it will go.

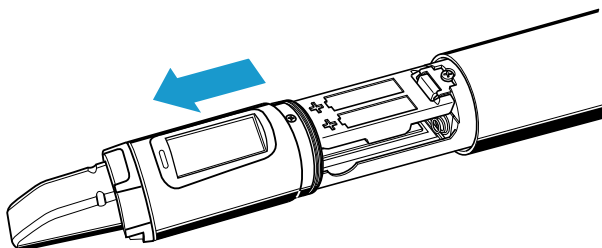

- ▶ Open the battery compartment cover 13.

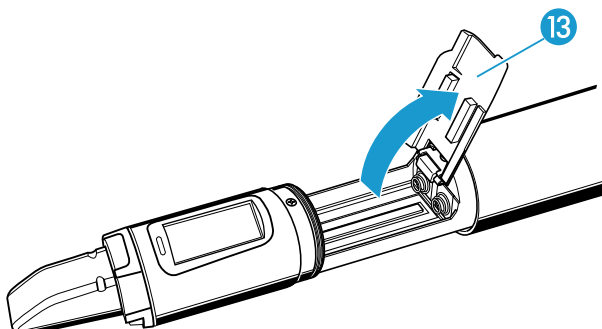

- ▶ Insert the batteries or the BA 2015 accupack as shown on the battery compartment cover. Observe correct polarity when inserting the batteries/accupack.

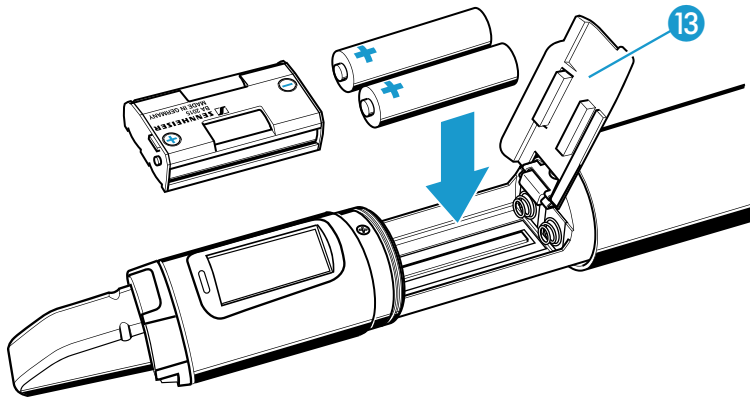

- ▶ Close the battery compartment cover 13.
- ▶ Push the battery compartment into the radio microphone's body.
- ▶ Screw the lower part of the radio microphone back to the radio microphone's body 4.

Charging the accupack

To charge the BA 2015 accupack (optional accessory) in the radio microphone:

- ▶ Use the LA 2 charging adapter to insert the radio microphone into the L 2015 charger (both the charger and the charging adapter are available as optional accessories – information on accessories can be found on our web site at www.sennheiser.com).

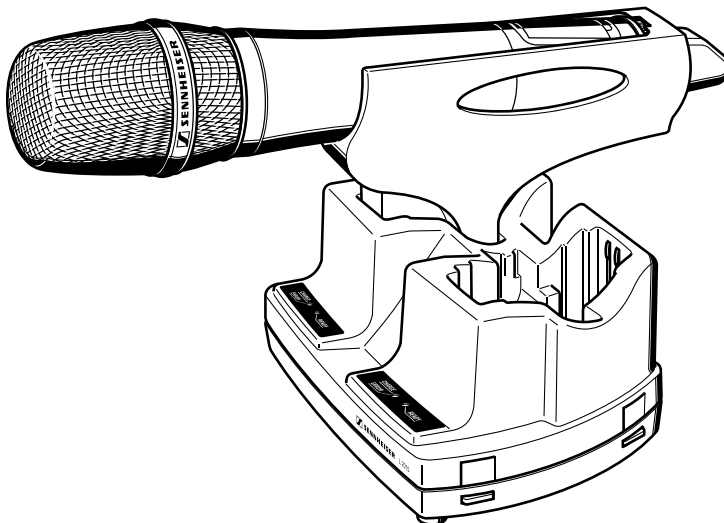

The LA 2 charging adapter and L 2015 charger can only charge the radio microphone with the BA 2015 accupack installed. Standard batteries (primary cells) or individual rechargeable battery cells cannot be charged in this way.

Changing the microphone head

- ▶ Unscrew the microphone head ①.

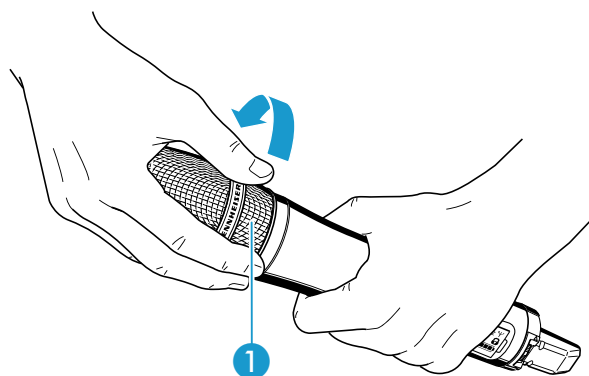

Do not touch the contacts of the radio microphone nor the contacts of the microphone head ①. The contacts can become dirty or damaged if touched.

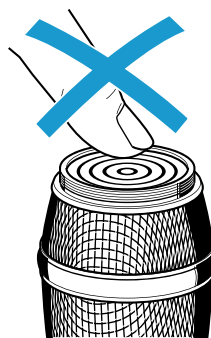
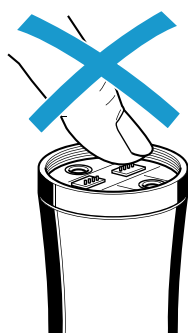

When unscrewing the microphone head ① during operation, the muting function is automatically activated. "MUTE" appears on the display panel.

When screwing the microphone head back to the radio microphone, the muting is canceled.

- ▶ Screw the desired microphone head to the radio microphone.

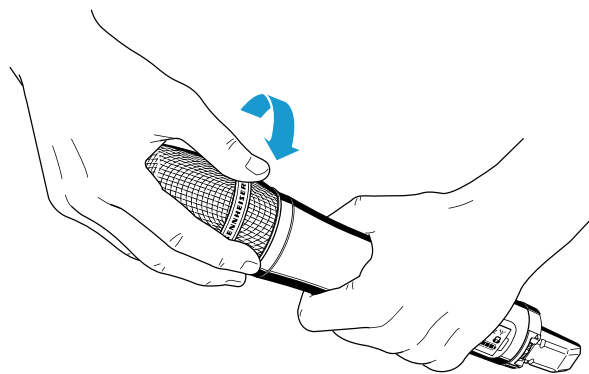

The radio microphone is operational again.

Changing the color-coded protection ring

The color-coded protection ring **8** prevents the multi-function switch **11** from accidental operation. Protection rings **8** in different colors are available as accessories. The protection rings allow you to clearly identify each radio microphone.

- ▶ Remove the color-coded protection ring **8** as shown.

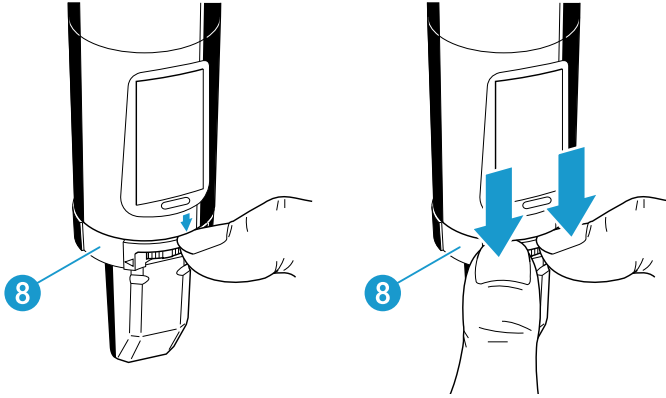

- ▶ Put on a new protection ring **8** as shown.

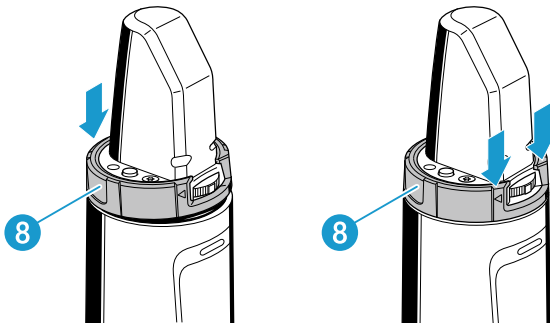

Using the radio microphone

To establish a transmission link, proceed as follows:

1. Switch the receiver on (see the instruction manual of the receiver).
2. Switch the radio microphone on (see below).
The transmission link is established and the display backlighting of the receiver changes from red to orange.

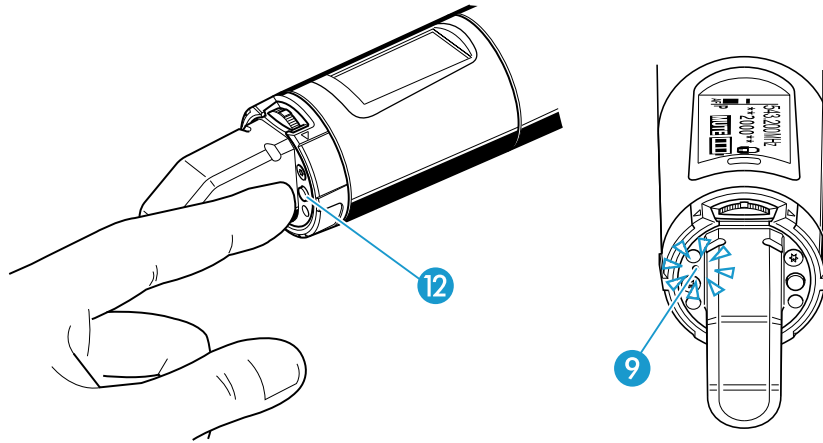

Switching the radio microphone on/off



To switch the radio microphone **on** (online operation):

- ON/OFF** ▶ Briefly press the **ON/OFF** button **12**.
-  The red **ON** LED **9** lights up. The “**Frequency/Name**” standard display appears on the display panel. The transmission icon **4** is displayed. The radio microphone transmits an RF signal.

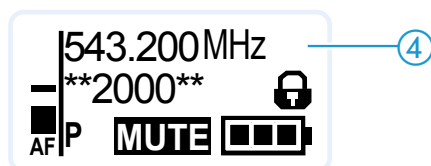

To switch the radio microphone **on** and to **deactivate the RF signal on switch-on** (offline operation):

- ON/OFF** ▶ Keep the **ON/OFF** button **12** pressed until “**RF Mute Off?**” appears on the display panel.
-  ▶ Move the multi-function switch upwards/downwards. “**RF Mute On?**” appears on the display panel.
-  ▶ Press the multi-function switch. The transmission frequency is displayed but the radio microphone does not transmit an RF signal. The transmission icon **4** is not displayed. When the pilot tone function is activated on both radio microphone and receiver, “**RF Mute**” appears on the receiver’s display panel.



Use this function to save battery power or to prepare a radio microphone for use during live operation without causing interference to existing transmission links.

To activate the RF signal:

- ON/OFF ▶ Briefly press the ON/OFF button.
 "RF Mute On?" appears on the display panel.
-  ▶ Move the multi-function switch upwards/downwards.
 "RF Mute Off?" appears on the display panel.
-  ▶ Press the multi-function switch.
 The transmission icon ④ is displayed again. The radio microphone transmits an RF signal.

To switch the radio microphone off:



- ▶ If necessary, deactivate the lock mode (see Seite 13).
- ON/OFF ▶ Keep the ON/OFF button ⑫ pressed until "OFF" appears on the display panel. The red ON LED ⑨ goes off and the display panel turns off.



When in the operating menu, pressing the ON/OFF button ⑫ will cancel your entry (ESC function) and return you to the current standard display.

Deactivating the lock mode temporarily

You can activate or deactivate the automatic lock mode via the "Auto Lock" menu item. If the lock mode is activated, you have to temporarily deactivate it in order to be able to operate the radio microphone:

-  / ON/OFF ▶ Press the multi-function switch or the ON/OFF button.
 "Locked" appears on the display panel.
-  ▶ Move the multi-function switch upwards/downwards.
 "Unlock?" appears on the display panel.
-  ▶ Press the multi-function switch.
- When you are in the operating menu, the lock mode remains deactivated until you exit the operating menu.
 - When one of the standard displays is shown, the lock mode is automatically activated after 10 seconds.

The lock mode icon ⑤ flashes prior to the lock mode being activated again.

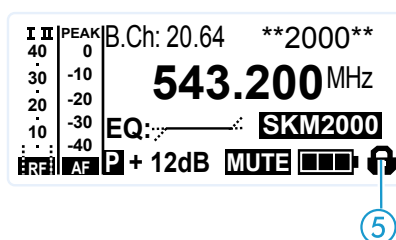



Deactivating the RF signal



Deactivating the RF signal on switch-on

For information on deactivating the RF signal on switch-on, refer to the chapter „Switching the radio microphone on/off“ auf Seite 12.

Deactivating the RF signal during operation



- ON/OFF**  ▶ When one of the standard displays is shown on the display panel, briefly press the **ON/OFF** button.
“RX Mute On?” appears on the display panel.
-  ▶ Press the multi-function switch to confirm your selection.

Activating the RF signal

- ON/OFF**  ▶ When one of the standard displays is shown on the display panel, briefly press the **ON/OFF** button.
“RX Mute Off?” appears on the display panel.
-  ▶ Press the multi-function switch to confirm your selection.

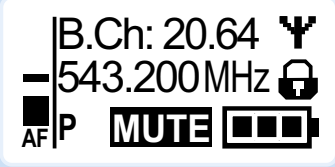

Selecting a standard display

-  ▶ Move the multi-function switch to select a standard display:

Contents of the display	Selectable standard display
	“Frequency/Name”
	“Channel/Frequency”
	“Name/Channel”

Using the operating menu

The buttons

Button	Function of the button
Press the ON/OFF button 	<ul style="list-style-type: none"> • Switches the radio microphone on and off • Cancels the entry and returns to the current standard display (ESC function) • Activates/deactivates the RF signal (special function, see Seite 14)
Press the multi-function switch 	<ul style="list-style-type: none"> • Changes from the current standard display to the operating menu • Calls up a menu item • Enters a submenu • Stores the settings and returns to the operating menu
Move the multi-function switch 	<ul style="list-style-type: none"> • Selects a standard display • Changes to the next/previous menu item • Changes the setting of a menu item

Overview of the operating menu

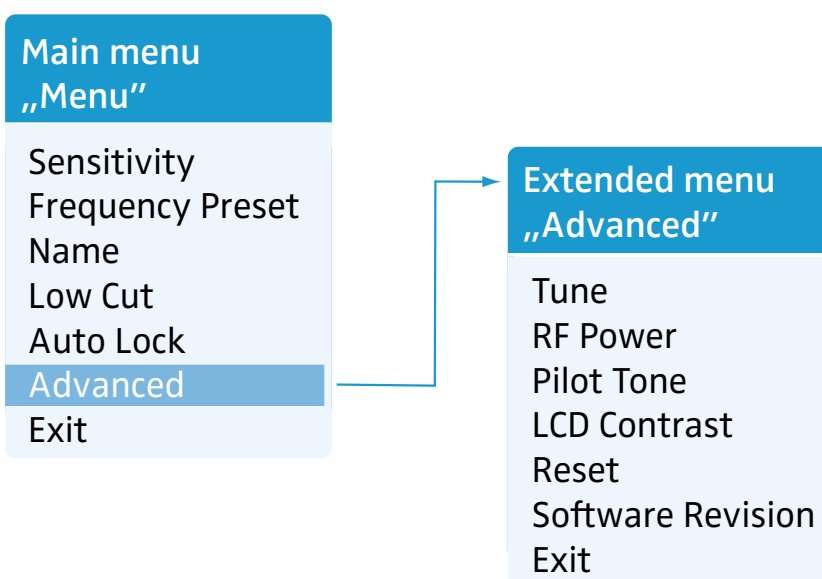

Display	Function of the menu item
Main menu "Menu"	
Sensitivity	Adjusts the sensitivity "AF"
Frequency Preset	Changes the frequency bank and the channel
Name	Enters the transmitter name
Low Cut	Activates/deactivates the low-cut filter
Auto Lock	Activates/deactivates the automatic lock mode
Advanced	Calls up the extended menu "Advanced Menu"
Exit	Exits the operating menu and returns to the current standard display

Extended menu "Advanced Menu"

Tune	Sets the transmission frequencies for the frequency banks "U1" to "U6"
	Special function: Sets a channel and a transmission frequency for the frequency banks "U1" to "U6"
RF Power	Adjusts the transmission power
Pilot Tone	Activates/deactivates the pilot tone transmission
LCD Contrast	Adjusts the contrast of the display panel
Reset	Resets the radio microphone
Software Revision	Displays the current software revision
Exit	Exits the extended menu "Advanced Menu" and returns to the main menu

Working with the operating menu



If the lock mode is activated, you have to deactivate it in order to be able to work with the operating menu (siehe Seite 13).

By way of example of the “Sensitivity” menu, this section describes how to use the operating menu.

Changing from the current standard display to the operating menu



- ▶ Press the multi-function switch.
The current standard display is replaced by the main menu.
The last selected menu item is displayed.

Selecting a menu item



- ▶ Move the multi-function switch to change to the “Sensitivity” menu item.
The current setting of the selected menu item is displayed:

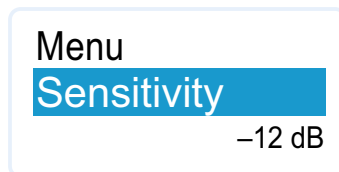

Changing and storing settings

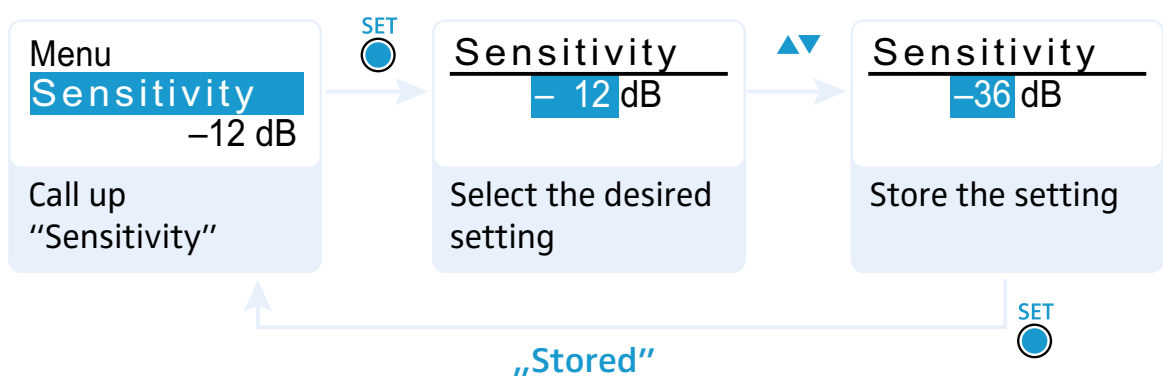

- ▶ Press the multi-function switch to call up the menu item.



- ▶ Move the multi-function switch to adjust the input sensitivity.



- ▶ Press the multi-function switch to store the setting.

Canceling an entry

- ON/OFF**  ▶ Press the **ON/OFF** button to cancel the entry.
The current standard display appears on the display panel.

To subsequently return to the last edited menu item:

-  ▶ Press the multi-function switch repeatedly until the last edited menu item appears.

Exiting a menu item

-  ▶ Change to the “Exit” menu item.

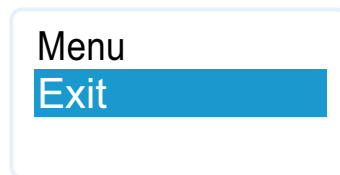

-  ▶ Confirm your selection.
You return to the next higher menu level.

To directly return to the current standard display:

- ON/OFF**  ▶ Press the **ON/OFF** button.

Synchronizing the radio microphone with a receiver

When synchronizing the radio microphone with a receiver, please observe the following:

- ▶ Only use a radio microphone and a receiver from the same frequency range (see the type plate on the radio microphone and the receiver).
- ▶ Make sure that the desired frequencies are listed in the enclosed frequency information sheet.
- ▶ Make sure that the desired frequencies are approved and legal in your country and, if necessary, apply for an operating license.

Synchronizing the radio microphone with the receiver – individual operation

Upon delivery, the radio microphone and the receiver are synchronized with each other. However, if you cannot establish a transmission link between radio microphone and receiver, you have to synchronize the channels of the devices.

For information on automatic synchronization of the radio microphone with the receiver (individual operation), refer to the instruction manual of the receiver. This information is marked with the **sync** icon.

Alternatively, you can set the channel on the radio microphone manually:

- ▶ Make sure that you set the radio microphone to the same frequency bank and the same channel as the receiver.

If you still cannot establish a transmission link, refer to the chapter „If a problem occurs ...“ auf Seite 21.

Synchronizing radio microphones with receivers – multi-channel operation

Combined with 2000 series receivers, 2000 series radio microphones can form transmission links that can be used in multi-channel systems. In order to ensure an intermodulation-free transmission, use the same frequency bank for all transmission links.

For information on automatic synchronization of radio microphones with receivers (multi-channel operation), refer to the instruction manual of your receiver. For more information on multi-channel operation, visit the corresponding product page at www.sennheiser.com.

Cleaning the radio microphone

CAUTION! Liquids can damage the electronics of the radio microphone!

Liquids entering the housing of the device can cause a short-circuit and damage the electronics.

- ▶ Keep all liquids away from the radio microphone.
-

- ▶ Use a slightly damp cloth to clean the radio microphone from time to time. Do not use any solvents or cleansing agents.

To clean the sound inlet basket of the microphone head:

CAUTION! Liquids will damage the microphone head!

Liquids will damage the microphone head.

- ▶ Only clean the upper sound inlet basket.
-

- ▶ Unscrew the upper sound inlet basket from the microphone head by turning it counterclockwise (see diagram).

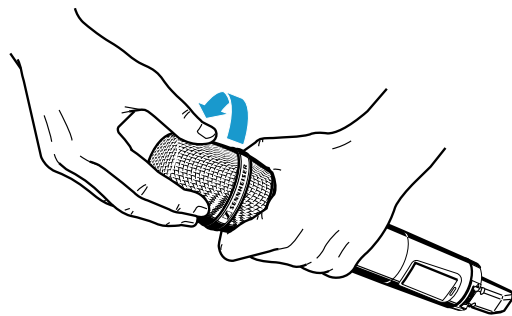

- ▶ Remove the foam insert.
- ▶ To clean the sound inlet basket:
 - Use a slightly damp cloth to clean the upper sound inlet basket from the inside and outside.
 - OR
 - Scrub with a brush and rinse with clear water.
- ▶ If necessary, clean the foam insert with a mild detergent or replace the foam insert.
- ▶ Dry the upper sound inlet basket.
- ▶ Dry the foam insert.
- ▶ Reinsert the foam insert.
- ▶ Replace the sound inlet basket on the microphone head and screw it tight.

You should also clean the contact rings of the microphone head from time to time:

- ▶ Wipe the contact rings of the microphone head with a dry cloth.

If a problem occurs ...

Problem	Possible cause	Possible solution
Radio microphone cannot be operated, "Locked" appears on the display panel	Lock mode is activated	Deactivate the lock mode (siehe Seite 13).
No operation indication	Batteries are flat or accupack is flat	Replace the batteries or recharge the accupack (siehe Seite 8).
No RF signal at the receiver	Radio microphone and receiver are not on the same channel	Synchronize the radio microphone with the receiver (siehe Seite 19). Set the radio microphone to the same channel as the receiver.
	Radio microphone is out of range	Check the squelch threshold setting on the receiver. Reduce the distance between radio microphone and receiving antenna. Increase the transmission power.
	RF signal is deactivated ("RF Mute")	Activate the RF signal (siehe Seite 14).
	RF signal available, no audio signal, "MUTE" appears on the display panel	Receiver's squelch threshold is adjusted too high
	Radio microphone doesn't transmit a pilot tone	Activate or deactivate the pilot tone transmission.
Audio signal has a high level of background noise / audio signal is distorted	Radio microphone's sensitivity is adjusted too low / too high	Adjust the input sensitivity.

If a problem occurs that is not listed in the above table or if the problem cannot be solved with the proposed solutions, please contact your local Sennheiser partner for assistance.

To find a Sennheiser partner in your country, search at www.sennheiser.com under "Service & Support".

Specifications

RF characteristics

Modulation	wideband FM
Frequency ranges	516–558, 558–626, 606–678, 626–698, 718–790, 790–865 MHz (Aw to Dw, Gw, GBw, see Seite 4)
Transmission frequencies	up to 3,000 frequencies, tuneable in steps of 25 kHz 20 frequency banks, each with up to 64 factory-preset channels 6 frequency banks, each with up to 64 user programmable channels
Switching bandwidth	up to 75 MHz
Nominal/peak deviation	± 24 kHz/ ± 48 kHz
Frequency stability	$\leq \pm 15$ ppm
RF output power at 50 Ω	switchable: typ. 10 mW (Low) typ. 30 mW (Standard) typ. 50 mW (High)
Pilot tone squelch	can be switched off

AF characteristics

Compander system	Sennheiser HDX
AF frequency response	80–18,000 Hz
Signal-to-noise ratio (1 mV, peak deviation)	≥ 120 dBA
THD	$\leq 0.9\%$
Adjustment range of input sensitivity	48 dB, adjustable in 6-dB steps

Overall device

Temperature range	-10°C to $+55^{\circ}\text{C}$
Power supply	2 AA size batteries, 1.5 V or BA 2015 accupack
Nominal voltage	2.4 V ---

Power consumption:

- at nominal voltage typ. 180 mA (30 mW)
- with switched-off radio microphone $\leq 25 \mu\text{A}$

Operating time typ. 8 hrs

Dimensions approx. \varnothing 50 x 265 mm

Weight (incl. batteries) approx. 380 g

In compliance with

Europe



EMC EN 301489-1/-9

Radio EN 300422-1/-2

Safety EN 60065
EN 62311 (SAR)

Approved by

Canada:

Industry Canada RSS 210

IC: 2099A-SKM2000

limited to 806 MHz

USA:

FCC-Part 74

FCC-ID: DMOSKM2000/

limited to 698 MHz

Microphone heads

Microphone head	Type	Sensitivity	Pick-up pattern	Max. SPL
MMD 835-1	dynamic	2.1 mV/Pa	cardioid	154 dB SPL
MMD 845-1	dynamic	1.6 mV/Pa	super-cardioid	154 dB SPL
MME 865-1	condenser	1.6 mV/Pa	super-cardioid	152 dB SPL
MMD 935-1	dynamic	2.5 mV/Pa	cardioid	154 dB SPL
MMD 945-1	dynamic	1.8 mV/Pa	super-cardioid	154 dB SPL
MMK 965-1	externally polarized dual diaphragm condenser microphone	5.7 mV/Pa 1.8 mV/Pa	cardioid/ super-cardioid, switchable	144 dB SPL 154 dB SPL
MD 9235	dynamic	1.8 mV/Pa	cardioid	163 dB SPL



Sennheiser electronic GmbH & Co. KG

Am Labor 1, 30900 Wedemark, Germany
www.sennheiser.com

Publ. 12/16, 549121