

P4R Receiver

for use with the PSM[®] 400 Wireless Personal Monitor System

ENGLISH.....	2
FRANÇAIS.....	8
DEUTSCH.....	15
ESPAÑOL.....	22
ITALIANO.....	28
DECLARATION OF CONFORMITY.....	35



WARNING!
**USING THIS SYSTEM AT EXCESSIVE VOLUMES CAN CAUSE
PERMANENT HEARING DAMAGE.
USE AS LOW A VOLUME AS POSSIBLE.**

In order to use this system safely, avoid prolonged listening at excessive sound pressure levels. Please use the following guidelines established by the Occupational Safety Health Administration (OSHA) on maximum time exposure to sound pressure levels before hearing damage occurs.

- 90 dB SPL at 8 hours
- 95 dB SPL at 4 hours
- 100 dB SPL at 2 hours
- 105 dB SPL at 1 hour
- 110 dB SPL at 1/2 hour
- 115 dB SPL at 15 minutes

120 dB SPL - avoid or damage may occur

It is difficult to measure the exact Sound Pressure Levels (SPL) present at the eardrum in live applications. In addition to the volume setting on the PSM, the SPL in the ear is affected by ambient sound from floor wedges or other devices. The isolation provided by the fit of quality earphones is also an important factor in determining the SPL in the ear.

Here are some general tips to follow in the use of this product to protect your ears from damage:

1. Turn up the volume control only far enough to hear properly.
2. Ringing in the ears may indicate that the gain levels are too high. Try lowering the gain levels.
3. Have your ears checked by an audiologist on a regular basis. If you experience wax buildup in your ears, stop using the system until an audiologist has examined your ears.
4. Wipe the earphones with an antiseptic before and after use to avoid infections. Stop using the earphones if they are causing great discomfort or infection.



This symbol indicates that there are important operating and maintenance instructions in the literature accompanying this unit.

Thank you for buying the P4R Receiver. The P4R is a component in the PSM[®] 400 family of wireless personal monitors. When used with a P4T Transmitter, it provides the many advantages of a wireless, in-ear monitoring system, including:

- **Improved Sound Quality** - high fidelity without the risk of feedback,
- **Increased Mobility** - your mix moves with you,
- **Personal Control** - through volume adjustment and MixMode[®].

For further information on the PSM 400 system, see the PSM 400 Wireless Personal Performance Pack user's guide, available on the world wide web at www.shure.com.

P4R RECEIVER FEATURES

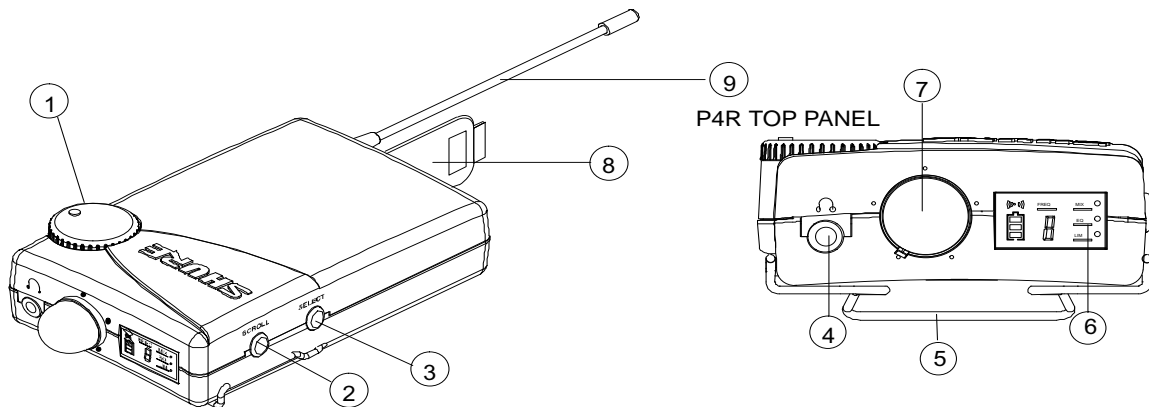



FIGURE 1

1. **Balance Knob:** This thumbwheel adjusts the left/right balance when the unit is in stereo and the mix 1/mix 2 balance when the unit is in MixMode.
2. **SCROLL Pushbutton:** Use with the SELECT pushbutton to control the functions in the LCD screen. See *Pushbutton Controls* on page 6.
3. **SELECT Pushbutton:** Use with the SCROLL pushbutton to control the functions in the LCD screen. See *Pushbutton Controls* on page 6.
4. **1/8" Earphone Output Jack:** Connects to earphones.
5. **Belt Clip:** Securely attaches the receiver to a belt, guitar strap or waist band.
6. **LCD Screen:** The LCD screen displays the status of various functions. See *LCD Screen* on page 4.
7. **ON/OFF/VOLUME Knob:** Turn clockwise past click to turn ON. Continue to turn clockwise to increase volume, counterclockwise to decrease volume.
8. **Battery Compartment Door:** See *Battery Installation* on page 4.
9. **Antenna:** An attached, flexible whip antenna receives radio frequency (RF) from the transmitter.

QUICK SET UP

1. Set up and activate a P4T transmitter according to directions in the P4T user's guide.
2. Open the battery door of the P4R receiver and insert a 9V alkaline battery, following the correct +/- alignment. See *Battery Installation* on page 4.
3. Turn the ON/OFF/VOLUME knob clockwise past click (ON). Keep volume set at minimum.
4. Set the P4R to the same reception channel as the P4T. See *Changing Reception Channel* on page 6.
5. Check the LCD screen to see if RF () is being received. See *LCD Screen* on page 4.
6. Plug earphones into earphone output jack.
7. Insert earphones into your ears as instructed in the earphone's user guide.
8. Increase the volume to a comfortable listening level.



WARNING: High volume levels may cause hearing damage!

9. Set the desired functions in the LCD screen. See *LCD Screen* on page 4, and *Pushbutton Controls* on page 6.

BATTERY INSTALLATION

1. Open the battery compartment door by pushing down and sliding towards antenna.
2. Insert a fresh 9V alkaline battery with the +/- terminals properly positioned (see Figure 2).
3. Close the battery compartment door.

NOTE: If battery compartment door will not close, the battery is not properly inserted.

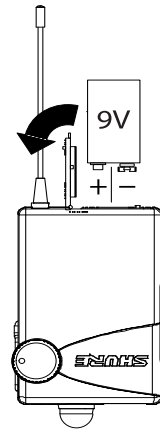

FIGURE 2

LCD SCREEN

The LCD screen on the top panel displays the status of various functions. The status of these functions can be changed using the SCROLL and SELECT pushbuttons (see *Pushbutton Controls* on page 6).

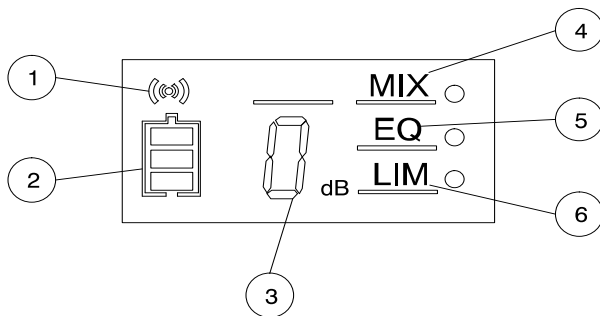

FIGURE 3

1. **RF:** Indicates the P4R receiver is receiving a transmission. Always check for RF reception prior to inserting earphones into ears.

2. **Battery Life Meter:** Indicates the approximate amount of voltage left in the battery. These voltages translate to time as follows:

- HIGH: 4-8 hours of operation.
- MEDIUM: 1-4 hours of operation.
- LOW: less than 1 hours of operation.

NOTE: If no bars are present within the battery life gauge, change the battery immediately. Battery life depends on many variables, including battery type (brand), earphones



WARNING! Turning the Limiter OFF defeats protection against hazardous sound levels!

MIXMODE/STEREO

The P4R receiver receives two signals (1/L and 2/R) from the P4T transmitter. The P4R processes these signals in either stereo or MixMode:

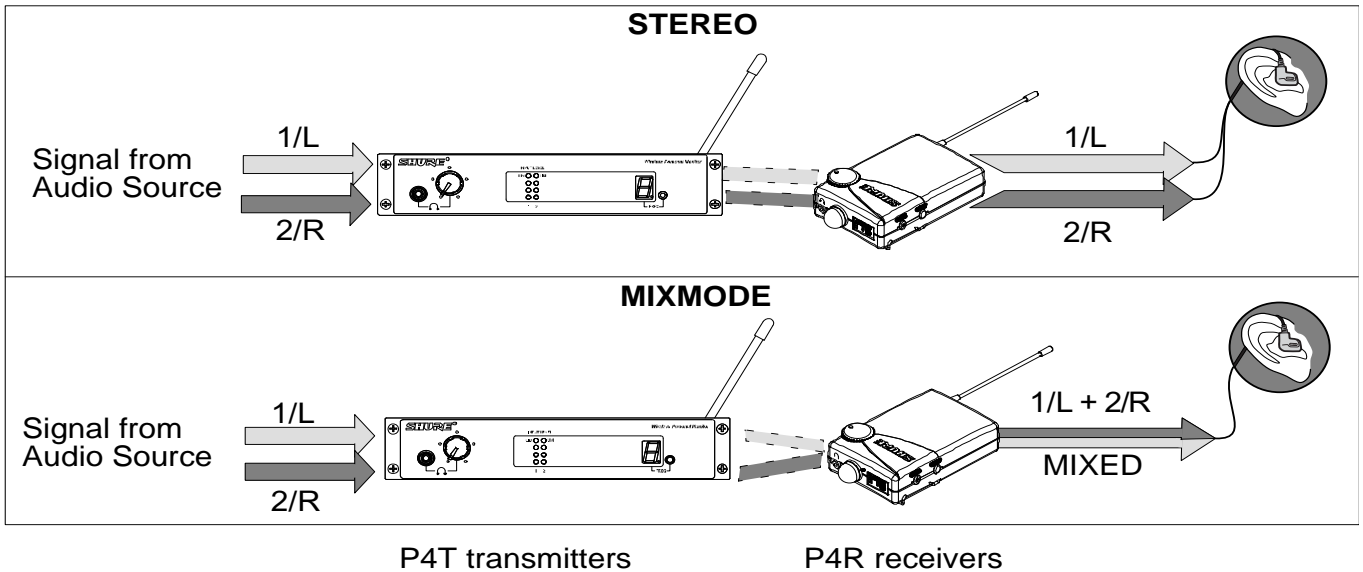

FIGURE 4

STEREO: In stereo, the signals remain separate so 1/L is heard through the left earphone and 2/R is heard through the right earphone. The balance knob on the receiver adjusts the balance between the left and right earphones.

MIXMODE: In MixMode, the signals are “mixed” in relation to one another using the balance knob, blending into one signal. The mixed signal is sent to *both* the left and right earphones.

USING MIXMODE

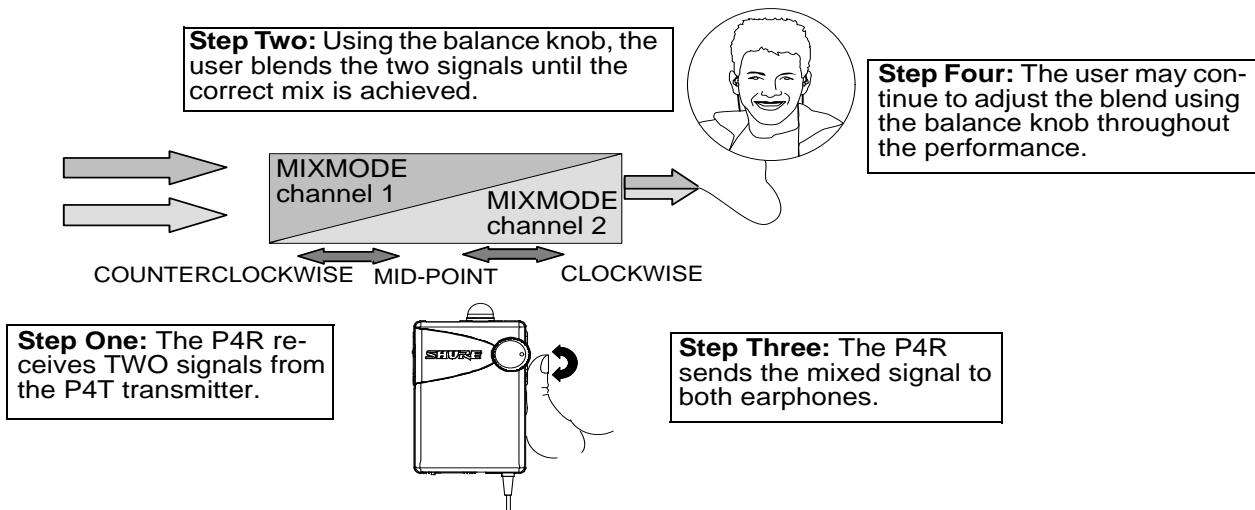

FIGURE 5

MIXMODE IN APPLICATIONS

MixMode is most useful when two distinct mixes are provided to the P4T transmitter, such as a band mix and a vocal mix. MixMode combines these two signals into one monitor mix and allows you to control this mix *during* the performance with the P4R receiver. For example, if the band overpowers the vocals in the mix, increase the level of the vocals and decrease the level of the band by simply adjusting the balance knob.

PUSHBUTTON CONTROLS

USING SCROLL AND SELECT PUSHBUTTONS

Push either pushbutton to activate the LCD screen. Push and hold the SCROLL pushbutton to scroll through the functions. The current function is underscored. Use the SELECT pushbutton to change the status of the underscored function.

CHANGING RECEPTION CHANNEL

1. Push and hold the SCROLL pushbutton.
2. Scroll to FREQ.
3. Push the SELECT pushbutton to select a channel (0-9 or A-F).

NOTE: Use the same reception channel as the matching P4T transmitter.

4. Push the SCROLL pushbutton to confirm changes.

CHANGING MIXMODE, HIGH FREQUENCY EQUALIZATION AND LIMITER STATUS.

1. Push and hold the SCROLL pushbutton. Scroll to the desired function (MIX, EQ, or LIM).
2. Push the SELECT pushbutton to toggle the function ON or OFF. A function is ON when a dot appears to the right of the function symbol.
3. Push the SCROLL pushbutton to confirm changes.

LOCKING OUT THE LCD SCREEN

Once the P4R's functions are set for use, lock out the LCD screen and pushbuttons to prevent unwanted changes during or between performances. Use the following instructions to lock out the front panel:

1. Set all functions to desired settings.
2. Hold down the SCROLL and SELECT pushbuttons simultaneously for five seconds (Figure 4 [A]).

NOTE: The reception channel will be replaced by dashes (Figure 4 [B]) when lock-out is engaged.

3. When lock out is engaged, the SCROLL and SELECT pushbuttons light the LCD display, but cannot change the status of any of the functions.
4. To disengage the lock out, hold the SCROLL and SELECT pushbuttons for five seconds until the reception channel is displayed again.

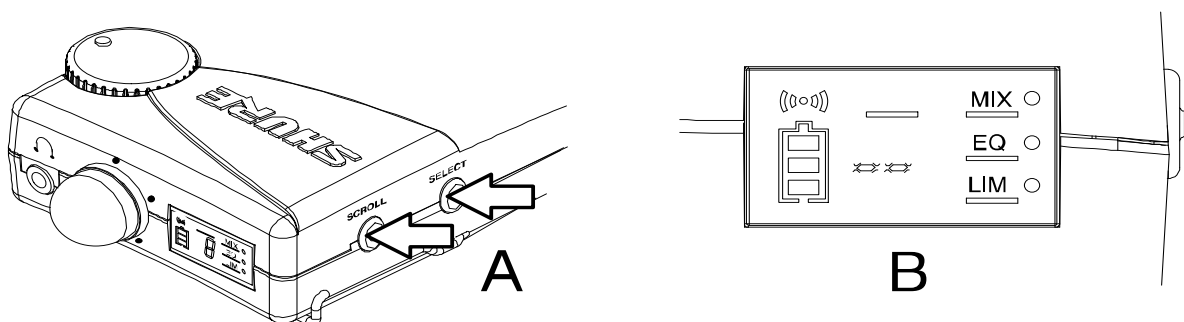

FIGURE 6

SPECIFICATIONS

RF Frequency Range

722 to 952 MHz (country dependent)

Operating Range

300 feet (environment dependent)

Audio Frequency Response50 Hz to 12 kHz (± 3 dB)**RF Sensitivity**1 μ V typical**Image Rejection**

55 dB typical

Spurious Rejection

60 dB typical

Squelch Threshold4.5 μ V typical**Antenna**

attached whip

Power Requirements

9 V alkaline battery

Battery Life

up to 8 hours, volume dependent

Audio Output Connector

3.5 mm Stereo

(Left = tip, Right = ring, Ground = sleeve)

Minimum Load Impedance16 Ω **Net Weight**

125 g (.28 lbs.)

Overall Dimensions

82.6 mm X 63.5 mm X 26.2 mm

(3 1/4 in. X 2 1/2 in. X 1 1/32 in.)

CERTIFICATION

Approved under the DECLARATION OF CONFORMITY provision of FCC Part 15. Certified by IC in Canada under RSS-123. Meets essential requirements of European R&TTE Directive 99/5/EC, eligible to bear the CE mark. Meets requirements of EMC standards EN 300 422 Parts 1 and 2 and EN 301 489 Parts 1 and 9.

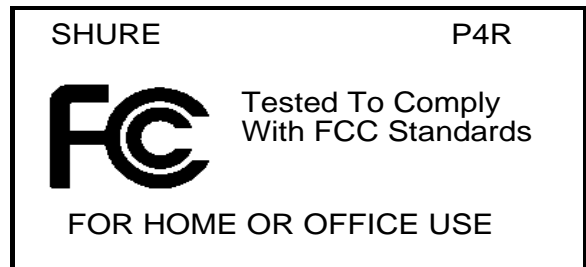

LICENSING

Changes or modifications not expressly approved by Shure Incorporated could void your authority to operate the equipment. Licensing of Shure wireless microphone equipment is the user's responsibility, and licensability depends on the user's classification and application, and on the selected frequency. Shure strongly urges the user to contact the appropriate telecommunications authority concerning proper licensing, and before choosing and ordering frequencies.

THIS RADIO EQUIPMENT IS INTENDED FOR USE IN MUSICAL PROFESSIONAL ENTERTAINMENT AND SIMILAR APPLICATIONS.

NOTE: THIS EQUIPMENT MAY BE CAPABLE OF OPERATING ON SOME FREQUENCIES NOT AU-

THORIZED IN YOUR REGION. PLEASE CONTACT YOUR NATIONAL AUTHORITY TO OBTAIN INFORMATION ON AUTHORIZED FREQUENCIES FOR WIRELESS MICROPHONE PRODUCTS IN YOUR REGION

Licensing: Note that a ministerial license to operate this equipment may be required in certain areas. Consult your national authority for possible requirements.

SHURE, the Shure logo, PSM and MIXMODE are registered trademarks of Shure Incorporated. DURACELL is a registered trademark of its respective owner.

FCC DECLARATION OF CONFORMITY

We,
of

Shure Incorporated
5800 Touhy Ave
Niles, Illinois, 60714-4608 U.S.A
(847) 600-2000

Declare under our sole responsibility that the following product

Model: P4R Description: Receiver

Has been tested and found to comply with the limits for an unintentional radiator device, and approved under the Declaration of Conformity provision of the Part 15 of the FCC rules.

Operation is subject to the following two conditions:

1. This device may not cause harmful interference.
2. This device must accept any interference received, including interference that may cause undesired operation.

Signed *Craig Kozokar* Date October 27, 2003
Name, Title Craig Kozokar
EMC Project Engineer, Corporate Quality, Shure Incorporated

Note: This equipment has been tested and found to comply with the limits for a Class B digital device, pursuant to part 15 of FCC Rules. These limits are designed to provide reasonable protection against harmful interference in a residential installation. This equipment generates, uses and can radiate radio frequency energy and, if not installed and used in accordance with the instructions, may cause harmful interference to radio communications. However, there is no guarantee that interference will not occur in a particular installation. If this equipment does cause harmful interference to radio or television reception, which can be determined by turning the equipment off and on, the user is encouraged to try to correct the interference by one or more of the following measures:

- Reorient or relocate the receiving antenna.
- Increase the separation between the equipment and the receiver.
- Connect the equipment into an outlet on a circuit different from that to which the receiver is connected.
- Consult the dealer or an experienced radio/TV technician for help.

EU DECLARATION OF CONFORMITY

We,
of

Shure Incorporated
5800 Touhy Ave
Niles, Illinois, 60714-4608 U.S.A
(847) 600-2000

Declare under our sole responsibility that the following product

Model: P4R Description: Personal Stereo Monitor Receiver

to which this Declaration relates

are in conformity to European Low Voltage Directive 73/23/EEC

are in conformity to European EMC Directive 89/336/EEC

are in conformity to European CE Marking Directive 93/68/EEC

The product complies with the following product family, harmonized or national standards:

P4R: EN 301 489 Part 1 and 9, ETSI 300 422-1 and ETSI 300 422-2

Manufacturer: Shure Incorporated

Signed  Date October 27, 2003

Name, Title Craig Kozdakar
EMC Project Engineer, Corporate Quality, Shure Incorporated

European Contact: Shure Europe GmbH
Wannenacker Str. 28, 74078 Heilbronn, Germany
Phone: 49-7131-7214-0, Fax: 49-7131-7214-14



United States:
Shure Incorporated
5800 West Touhy Avenue
Niles, IL 60714-4608 USA

Phone: 847-600-2000
Fax: 847-600-1212
Email: info@shure.com

www.shure.com

Europe, Middle East, Africa:
Shure Europe GmbH
Wannenäckestr. 28,
74078 Heilbronn, Germany

Phone: 49-7131-72140
Fax: 49-7131-721414
Email: info@shure.de

Asia, Pacific:
Shure Asia Limited
Unit 301, 3rd Floor
Citicorp Centre
18, Whitfield Road
Causeway Bay, Hong Kong

Phone: 852-2893-4290
Fax: 852-2893-4055
Email: info@shure.com.hk

**Canada, Latin America,
Caribbean:**
Shure Incorporated
5800 West Touhy Avenue
Niles, IL 60714-4608 USA

Phone: 847-600-2000
Fax: 847-600-6446
Email: international@shure.com

©2008 Shure Incorporated