

The SHURE logo is displayed in a bold, italicized, black font with a bright green outline, set against a black rectangular background with rounded corners.

SHURE

PSM300

Stereo Personal Monitor System

Online user guide for PSM300 stereo personal monitor system.
Version: 2.4 (2022-G)

Table of Contents

PSM300 Stereo Personal Monitor System	3	Signal Routing to External Devices (Combination Systems)	13
IMPORTANT SAFETY INSTRUCTIONS	3	System Setup and Configuration	14
SAFETY PRECAUTIONS	3	Rack Mounting	14
CAUTION	4	Power, Audio, and RF Connections	15
WARNING	4	Scanning for the Best Open Channel	16
WARNING	4	Creating a Wireless Connection Between Receivers and Transmitters (Sync)	16
PSM®300	4	Adjusting Gain and Listening Volume	18
Features	5	Operation	20
Included Components	5	Creating Monitor Mixes	20
System Overview	6	MixMode and Stereo Monitoring	21
Hardware	7	Troubleshooting	23
P3T Transmitter Front and Rear Panels	7	Specifications	23
P3T Transmitter Display	8	Frequency Range and Transmitter Output Power	27
P3R Wireless Receiver	10	Frequency Range and Transmitter Output Level	27
Battery Life	11	Optional Accessories and Replacement Parts	28
System Applications	12	Frequencies for European Countries	28
Single System for an Individual Performer	12	Certifications	33
Single Transmitter with Multiple Receivers	12	Important Product Information	33
Multiple Transmitters with Separate Mixes	13		

PSM300

Stereo Personal Monitor System

IMPORTANT SAFETY INSTRUCTIONS



1. READ these instructions.
2. KEEP these instructions.
3. HEED all warnings.
4. FOLLOW all instructions.
5. DO NOT use this apparatus near water.
6. CLEAN ONLY with dry cloth.
7. DO NOT block any ventilation openings. Allow sufficient distances for adequate ventilation and install in accordance with the manufacturer's instructions.
8. DO NOT install near any heat sources such as open flames, radiators, heat registers, stoves, or other apparatus (including amplifiers) that produce heat. Do not place any open flame sources on the product.
9. DO NOT defeat the safety purpose of the polarized or grounding type plug. A polarized plug has two blades with one wider than the other. A grounding type plug has two blades and a third grounding prong. The wider blade or the third prong are provided for your safety. If the provided plug does not fit into your outlet, consult an electrician for replacement of the obsolete outlet.
10. PROTECT the power cord from being walked on or pinched, particularly at plugs, convenience receptacles, and the point where they exit from the apparatus.
11. ONLY USE attachments/accessories specified by the manufacturer.
12. USE only with a cart, stand, tripod, bracket, or table specified by the manufacturer, or sold with the apparatus. When a cart is used, use caution when moving the cart/apparatus combination to avoid injury from tip-over.



13. UNPLUG this apparatus during lightning storms or when unused for long periods of time.
 14. REFER all servicing to qualified service personnel. Servicing is required when the apparatus has been damaged in any way, such as power supply cord or plug is damaged, liquid has been spilled or objects have fallen into the apparatus, the apparatus has been exposed to rain or moisture, does not operate normally, or has been dropped.
 15. DO NOT expose the apparatus to dripping and splashing. DO NOT put objects filled with liquids, such as vases, on the apparatus.
 16. The MAINS plug or an appliance coupler shall remain readily operable.
 17. The airborne noise of the Apparatus does not exceed 70dB (A).
 18. Apparatus with CLASS I construction shall be connected to a MAINS socket outlet with a protective earthing connection.
 19. To reduce the risk of fire or electric shock, do not expose this apparatus to rain or moisture.
 20. Do not attempt to modify this product. Doing so could result in personal injury and/or product failure.
 21. Operate this product within its specified operating temperature range.
-

SAFETY PRECAUTIONS

The possible results of incorrect use are marked by one of the two symbols—"WARNING" and "CAUTION"—depending on the imminence of the danger and the severity of the damage.

	WARNING: Ignoring these warnings may cause severe injury or death as a result of incorrect operation.
	CAUTION: Ignoring these cautions may cause moderate injury or property damage as a result of incorrect operation.

CAUTION

- Never disassemble or modify the device, as failures may result.
- Do not subject to extreme force and do not pull on the cable or failures may result.
- Keep the product dry and avoid exposure to extreme temperatures and humidity.

WARNING

- If water or other foreign objects enter the inside of the device, fire or electric shock may result.
- Do not attempt to modify this product. Doing so could result in personal injury and/or product failure.

This device is able to produce sound volume higher than 85 dB SPL. Please check your maximum allowed continuous noise exposure level based on your national employment protection requirements.

This product is intended for professional use only. This product should only be sold through professional sales channels.

WARNING

LISTENING TO AUDIO AT EXCESSIVE VOLUMES CAN CAUSE PERMANENT HEARING DAMAGE. USE AS LOW A VOLUME AS POSSIBLE. Over exposure to excessive sound levels can damage your ears resulting in permanent noise-induced hearing loss (NIHL). Please use the following guidelines established by the Occupational Safety Health Administration (OSHA) on maximum time exposure to sound pressure levels before hearing damage occurs.

90 dB SPL at 8 hours	95 dB SPL at 4 hours	100 dB SPL at 2 hours	105 dB SPL at 1 hour
110 dB SPL at ½ hour	115 dB SPL at 15 minutes	120 dB SPL Avoid or damage may occur	

PSM[®] 300

The PSM300 Personal Monitor System delivers wireless stereo monitoring for improved clarity and reduced feedback over traditional stage wedges. Performers can create their own custom mixes by adjusting the stereo blend and overall volume level at the bodypack, resulting in lower volume on stage and enhanced audio detail. Easy to set up and operate, PSM300 features one-touch frequency syncing and solid wireless RF stability between transmitters and receivers. With rugged, dependable hardware and hard-working technology, Shure PSM300 Personal Monitor Systems deliver a greatly improved monitoring experience on stage.

Features

- Send two channels of audio wirelessly to performers onstage
- Solid RF connection over a 300 foot (90 meter) range
- Create a personal mix on each bodypack with adjustable stereo balance or MixMode[®] two-channel mono blend.
- Up to 90 dB signal-to-noise ratio provides clear, detailed audio at any volume
- Systems available with Shure Sound Isolating[™] earphones
- One-touch scan and IR sync quickly and easily assigns a clean wireless channel
- No complicated menus, just simple volume and mix controls that focus on the performance
- All-metal half-rack transmitter
- Slim, lightweight bodypack attaches easily to a belt or guitar strap

Included Components

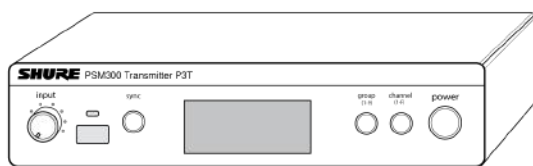

P3T Transmitter



Carrying Bag

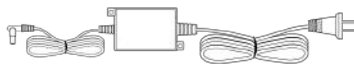

PS24 Power Supply

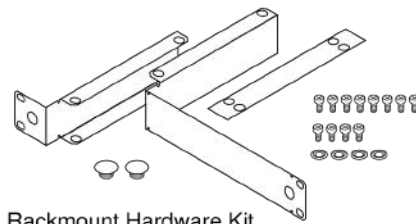

Rackmount Hardware Kit



P3R or P3RA
Bodypack Receiver



SE112 or
SE215
Earphones

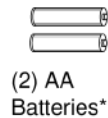

(2) AA
Batteries*



BNC Bulkhead
Adapter **



1/4 Wave Antenna

*Not included in Argentina

**Not included in JB Band model

Each performer uses the MixMode knob on the bodypack to control their own mix between the instruments and vocals .

Hardware

P3T Transmitter Front and Rear Panels

① Input Level Control

Adjusts the level of the incoming audio signal

② IR Sync Window

Sends and receives group/channel data to sync receivers with the transmitter

③ Sync Button

Press to synchronize the transmitter and receiver to the same group and channel

Note: Sync data is sent through the IR sync window

④ LCD Display

Displays audio, RF, and system information

⑤ Group Button

Press to scroll through group settings

⑥ Channel Button

Press to scroll through channel settings

⑦ Power

Turns power on or off

⑧ Power Input

Connect the supplied Shure PS24 external power supply

⑨ Mono/Stereo-MX Switch

StereoMX	Sends a two-channel stereo mix to the receiver
Mono	Sends a summed audio mix to both receiver channels

⑩ Line/Aux Switch

Adjust the input sensitivity using the following as a connection reference:

Aux (-10 dBV):	Consumer audio devices, such as computers or portable media players
Line (+4 dBu):	Mixers or other professional audio devices

11 Loop Outputs (1/4 Inch TRS, Balanced)

Connect outputs to additional PSM systems or other audio devices

12 Audio Inputs (1/4 Inch TRS, Balanced)

Connect to mixer outputs or other audio sources for monitoring by the performers

13 BNC Antenna Connector

Connect the supplied 1/4 wave antenna, directional antenna, or a Shure PA411 antenna combiner

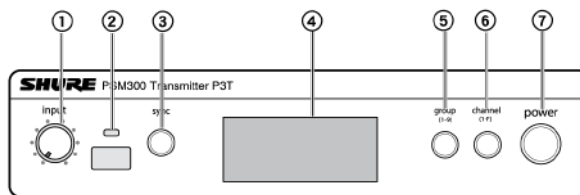

P3T Front Panel

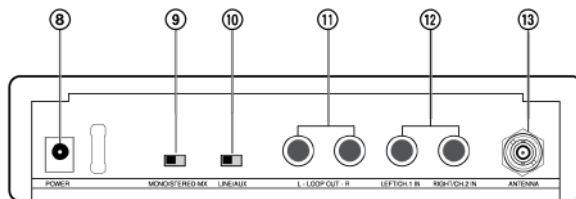

P3T Rear Panel

Note: For JB band models, the antenna is permanently fixed to the transmitter. Removing the antenna on JB band models is prohibited by law in Japan, and attempting to do so may cause damage to the transmitter.

P3T Transmitter Display

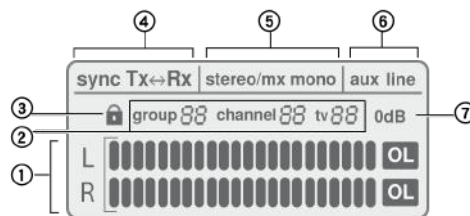

1 Audio Input Meter

Indicates the audio signal level

2 Group / Channel / TV Setting

Displays selected group and channel settings and the corresponding television channel

Note: the TV indicator only applies to U.S.A. channels, and remains blank in other regions

③ Lock Status

To lock or unlock the controls, press and hold the group and channel buttons until the lock icon appears/disappears.

④ Sync Status

Appears after a successful sync between the transmitter and receiver. The direction of the sync is shown as Tx>Rx (transmitter sends frequency to receiver) or Tx (receiver sends frequency to transmitter).

⑤ Stereo-MX / Mono Mix

Indicates whether the audio sent to the receiver is a single or two-channel mix (corresponds to the Stereo-MX/Mono switch on the rear panel).

⑥ Aux / Line Mode

Indicates the input sensitivity setting (corresponds to the Aux/Line switch on the rear panel)

⑦ 0 dB Indicator

Turns on when input signal reaches 0 dB. Refer to the section on adjusting gain and listening volume for information on how to use this icon.

P3R Wireless Receiver

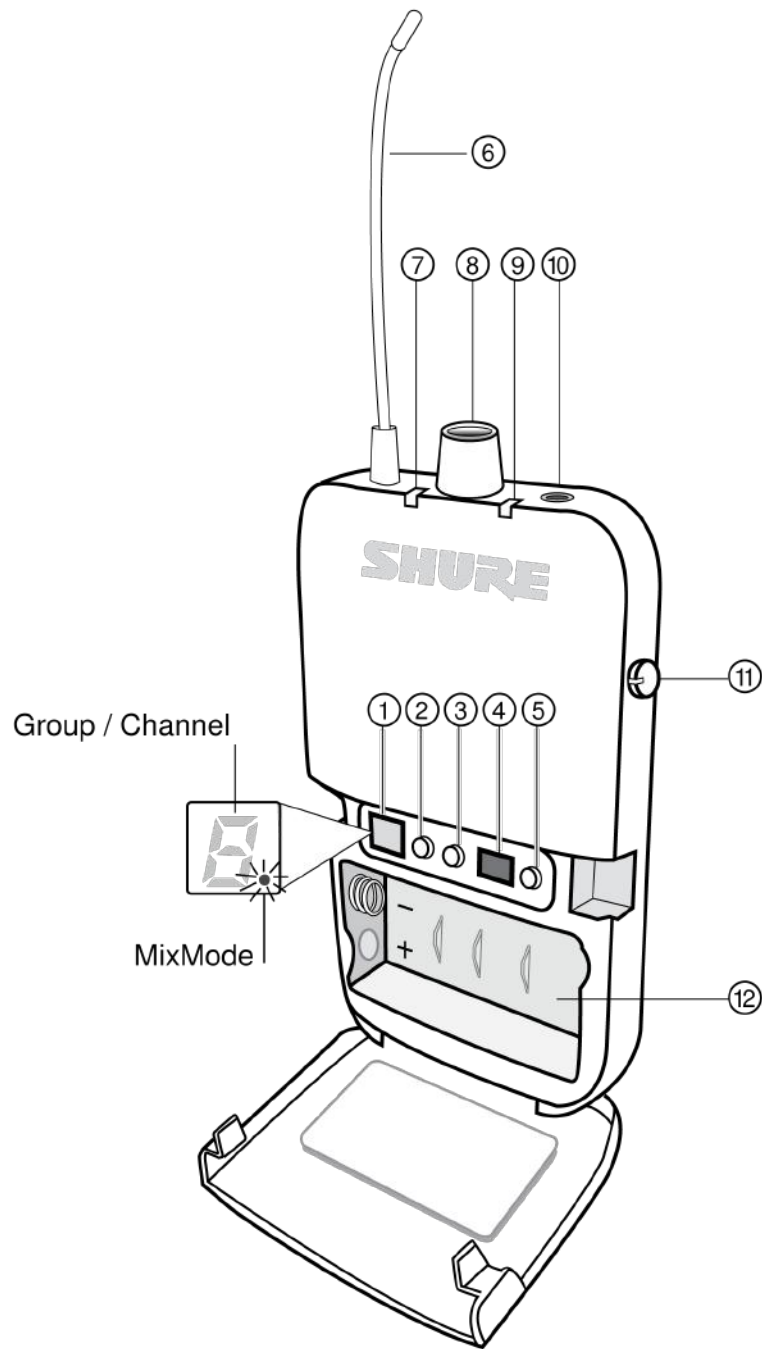

P3R

① Display

Shows group, channel, and MixMode settings

② Group Button

- Press to display group
- Press and hold to edit the group, then press to scroll when display flashes

③ Channel Button

- Press to display channel
- Press and hold to edit the channel, then press to scroll when display flashes

④ IR Sync Window

Sends and receives sync data between the receiver and transmitter

⑤ Scan Button

- Press and hold to perform a **group scan**
- Press to perform a **channel scan**

Note: A channel scan selects the best channel in the current group. A group scan finds the group with the most open channels and selects the first available channel in that group.

⑥ Antenna

⑦ Power LED Indicator

Indicates when receiver is on, remaining battery life, and when power-save mode is active. See battery life table for more information.

⑧ Power Switch / Volume Control Knob

Turns the receiver on/off and adjusts master headphone volume level

⑨ RF LED Indicator (blue)

Illuminates when tuned to an active transmitter group and channel

⑩ Headphone Output

Connects to earphones or headphones

⑪ MixMode Control Knob

- When operating in MixMode, this knob blends channels 1 and 2 into a single mix
- When operating in stereo mode, this knob adjusts the left/right balance

⑫ Battery Compartment

Holds 2 x AA batteries

P3RA Receiver

For more demanding applications, Shure offers the P3RA receiver, which features all-metal construction and advanced menu navigation in addition to the features included on the P3R receiver. For more information, please visit www.shure.com.

Battery Life

LED Behavior	Remaining Runtime (Hours)
Green	5-7
Amber	1-3

LED Behavior	Remaining Runtime (Hours)
Red (solid)	0.5-1
Red (flashing)	0

Battery life was measured using Energizer™ alkaline batteries, under the following conditions:

- Transmitter sensitivity: Line (+4dBu)
- Audio output from receiver: dB through Shure SE112 earphones

Power-save mode: When there are no earphones plugged in, the receiver enters power-save mode to preserve battery life. The LED slowly fades on/off in this mode and continues to display the color that represents the remaining battery life.

System Applications

Refer to the following PSM300 system scenarios prior to installation. Understanding the configuration options before setting up helps to identify signal routing requirements and plan for future expansion. Specific information on how to set up the PSM300 system and create mixes for monitoring can be found in the "System Setup and Configuration" and "Operation" sections of this user guide.

Single System for an Individual Performer

This configuration provides in-ear monitoring in a solo performance, or in a group performance in which only one person requires wireless monitoring. This system can be expanded for multiple performers by using additional P3R bodypack receivers tuned to the same transmitter.

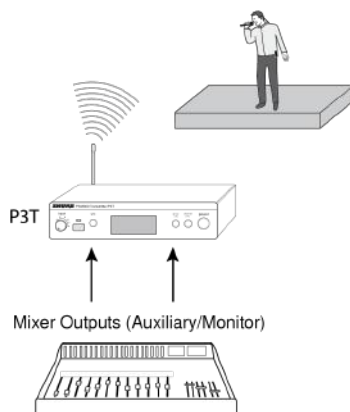

Single Transmitter with Multiple Receivers

Multiple performers can monitor audio from the same transmitter and still adjust the signal at their bodypack to personalize the mix. Simply tune each bodypack to the same frequency as the transmitter and use the MixMode knob to adjust the mix.

MixMode or Stereo Operation:

Each performer has the option of setting their bodypack to MixMode or Stereo when the transmitter is set to Stereo-MX. When the bodypack is powered on, it is set to stereo by default. To operate in MixMode, hold the GROUP button when turning the power on. For information on these modes, see "MixMode and Stereo Monitoring".

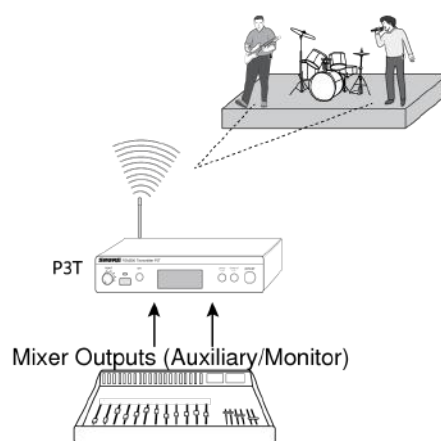

Multiple Transmitters with Separate Mixes

When several performers in a group have different monitoring requirements, multiple PSM300 systems may be used simultaneously to send different mixes through each transmitter. This setup requires a mixer with two monitor/auxiliary outputs for each transmitter.

Tip: To simplify setup in applications that involve multiple transmitters, Shure offers the PA411 antenna and power distribution system, which supplies up to four PSM transmitters with power and RF from a single source.

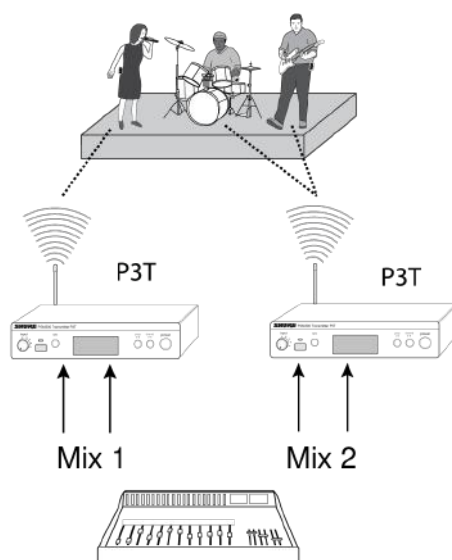

Signal Routing to External Devices (Combination Systems)

The LOOP outputs pass audio to an external device, such as other personal monitoring systems, recording devices, or stage monitors. The signal at the LOOP outputs is identical to the signal coming from the mixer, and is not affected by the transmitter volume or input sensitivity (line/aux) settings. This makes the LOOP outputs particularly useful when using a mixer that has one or two monitor/auxiliary sends.

Using the PSM300 simultaneously with Loudspeakers:

A combination monitoring system can be used, where some of the performers are using the PSM300 wireless system and others are listening through loudspeakers on stage.

Note: If using passive stage monitors, the P3T outputs must be connected to an amplifier. Active (amplified) speakers can be connected directly to the P3T outputs.

Using the PSM300 Combined with Other Wireless Monitoring Systems

In a scenario where two performers have their own wireless monitoring systems (one Shure PSM300 system and one third-party system, for example), the PSM300 can pass the signal from the mixer on to the second monitoring system.

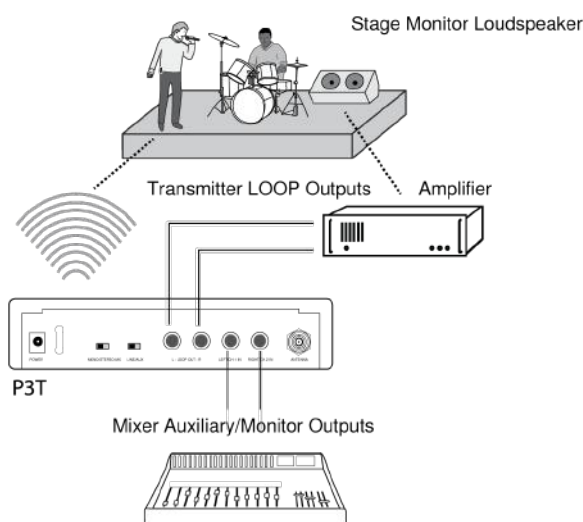

System Setup and Configuration

Rack Mounting

The P3T Transmitter can be mounted in a standard 19-inch rack. Up to two units can be mounted in a single rack space. If using multiple P3T transmitters, the Shure PA411 Antenna Combiner system can be used to consolidate and distribute all RF and power for up to four transmitters.

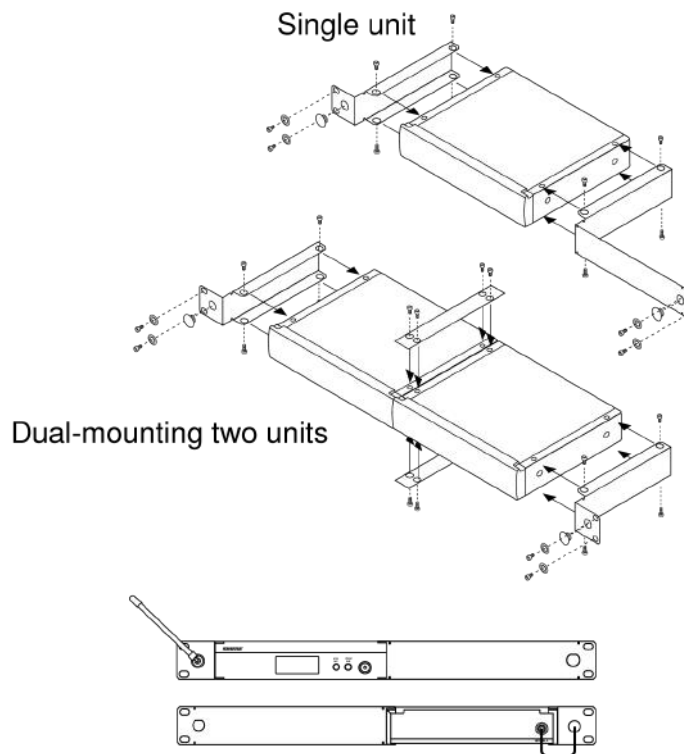

Note: Always use both straddle bars when mounting two units.

Power, Audio, and RF Connections

1. Use the power adapter to connect the P3T to an AC power source.
2. Install 2 AA batteries in the bodypack receiver.
3. Attach the antenna to the BNC antenna connector on the P3T rear panel.
4. Connect the mixer or audio source to the P3T audio inputs using ¼ inch balanced cables.

Important: When connecting to only one transmitter input, use the LEFT/CH1 input. Set the transmitter to MONO to hear audio on both channels of the receiver.

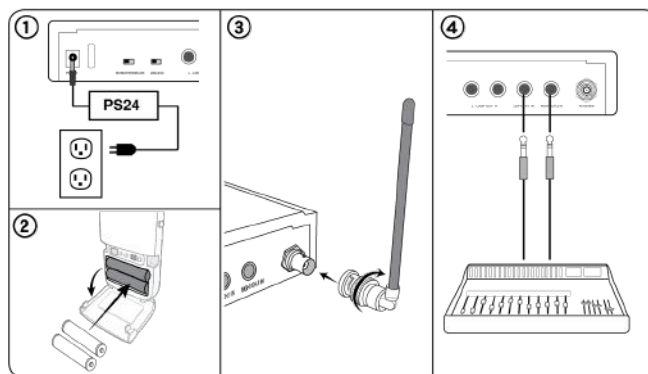

Scanning for the Best Open Channel

Follow these steps to scan the RF environment and find the best available frequency for operation:

1. Turn on the bodypack receiver and any potential sources of interference, including wireless systems, computers, audio equipment, cellular phones, LED panels, and other electronic devices that will be in use during a performance.
2. Make sure the P3T transmitter is **OFF**.
3. Position the receiver in the performance area and press SCAN to survey the available channels within the current group setting.

If using several PSM300 systems or operating in a location with a high volume of wireless devices, perform a group scan first, followed by a channel scan:

Group Scan: Press and hold the SCAN button on the receiver.

Channel Scan: Press the SCAN button on the receiver.

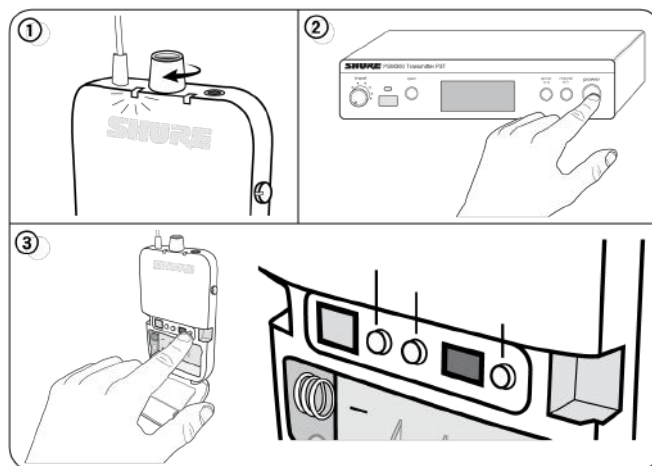

Creating a Wireless Connection Between Receivers and Transmitters (Sync)

To pass audio from the transmitter to the receiver, both must be tuned to the same frequency. The easiest way to configure the system is to use the automatic sync feature. This transfers group and channel settings with a press of a button. Based on your system configuration, use one of the following processes to sync the components:

Align the IR windows to sync the re



Align the IR windows to sync the receiver and transmitter

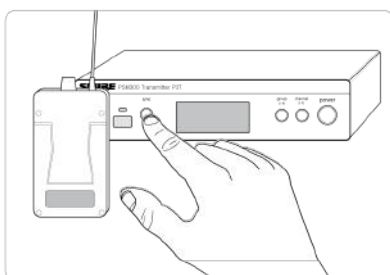

Pressing the SYNC button transfers group/channel data

Single Transmitter and Receiver

The following sync procedure should be used with a setup that consists of a single transmitter and receiver, unless a group/channel setting has been assigned prior to a performance.

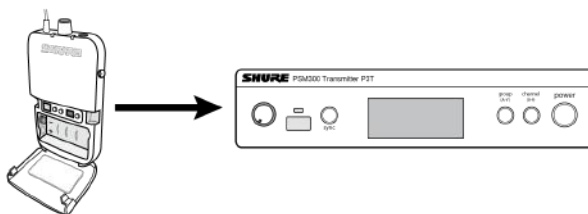

Sync from receiver to transmitter:

1. Perform a scan on the receiver (see "Scanning for the Best Open Channel" for best practices).
2. Align the IR windows on the receiver and transmitter. The windows should be 6-11 cm apart.
3. Press the SYNC button on the transmitter while the blue RF LED on the receiver is flashing.
4. The Transmitter displays SYNC when the sync is successful. The arrow between Rx (receiver) and Tx (transmitter) shows the direction of the sync.

Note: When the RF LED on the receiver is flashing after performing a scan, the receiver sends its frequency setting to the transmitter. After it stops flashing, pressing SYNC sends the frequency setting from the transmitter to the receiver.

Single Transmitter and Multiple Receivers

The following sync procedure should be used with a setup that consists of a single transmitter with multiple receivers, or if a specific group/channel setting has been assigned to the transmitter prior to a performance.

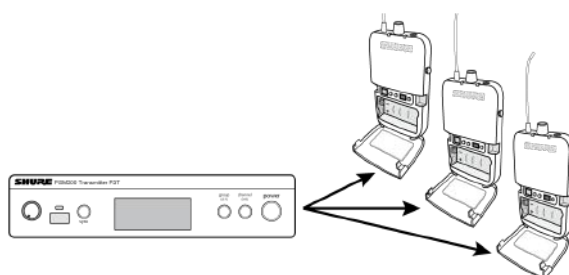

Sync from transmitter to receivers:

1. Sync the first receiver to the transmitter using the sync procedure for a single receiver. Performing a scan and using the resulting group and channel from the receiver is recommended.
2. Set additional receivers to the transmitter frequency (one at a time) using IR sync:
 - Align the IR windows on the receiver and transmitter and press SYNC.
 - The receiver LED should not be flashing when pressing SYNC.

Note: Receivers can also be manually tuned to the transmitter if an IR sync is not practical.

Multiple Transmitters and Multiple Receivers

1. Set up the first transmitter and all associated receivers according to the appropriate sync procedure. Keep the transmitter and all receivers from this first system powered on when setting up additional systems.
2. Set up each additional system using the appropriate sync process. Always leave each new system on before setting up an additional one.

Manual Selection

If frequencies have been planned ahead of time, the group and channel can be set manually without performing a scan. Refer to the frequency table at the end of this user guide to identify frequencies for each group/channel setting.

To select group/channel settings on the receiver and transmitter:

1. Press GROUP to scroll through group settings.
2. Press CHANNEL to scroll through channel settings within the selected group.

Adjusting Gain and Listening Volume

For the best audio quality, start by adjusting the levels from the mixer or audio source, and then adjust levels through the PSM300 system. This approach corresponds to the way that the audio signal flows through the system, and maximizes the signal-to-noise ratio.

Before you begin: verify all signal routing and gain settings at the mixer or source prior to adjusting any levels from the PSM300 system. If the sound is distorted or faint when it enters the P3T transmitter, there is likely an issue elsewhere in the signal chain that needs to be resolved.

① Adjust Transmitter Levels:

Input Sensitivity

Select the setting that matches the input source:

Line (+4 dBu)	Use with mixers or other professional audio devices that send line-level signals.
Aux (-10 dBV)	Use when connecting consumer audio devices such as portable audio players or computers.

Note: When using consumer audio devices, the output volume of the device should typically be adjusted as close to the maximum setting as possible without distorting or clipping at the output of the device. This maximizes the signal-to-noise ratio.

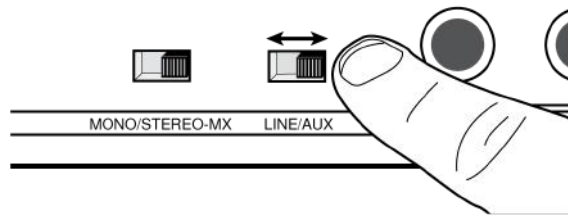

Input Level

Adjust the level so that average levels on the audio meter reach approximately 75% of the full range. The highest levels should occasionally hit the 0dB indicator on the audio input meter, without reaching the OL (overload) indicator.

Tip: If a sound check before the performance is possible, everyone should play at the loudest anticipated volume so that attenuation is not required during the performance.

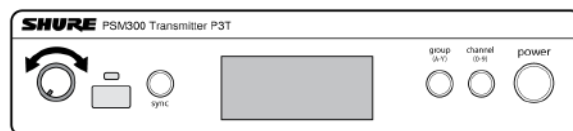

② Adjust Receiver Volume:

After levels are established at the mixer and transmitter, use the headphone volume control on the bodypack receiver to adjust overall listening volume. For information on adjusting the left/right balance or customizing the mix blend, see "MixMode and Stereo Monitoring".

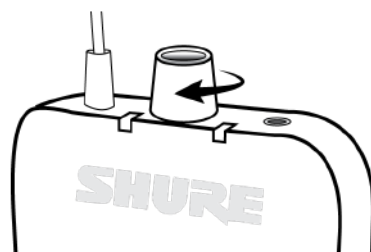

Operation

Creating Monitor Mixes

The mix that performers hear on stage is usually different than the mix heard by the audience. In live sound applications, the engineer creates a separate mix to send to the performer by routing the input signals to specified mixer outputs, usually called **Monitor** or **Auxiliary** outputs.

The following scenario demonstrates a generic signal path for monitoring mixes, and may not reflect the routing for all mixer types. Consult the user guide for your mixer for detailed signal routing options.

<p>① Mixer Channel</p>	<p>Each mixer channel controls audio processing and routing for a single audio source. In this example, a vocal microphone is plugged into the mixer channel.</p>
<p>② Monitor/Auxiliary Sends</p>	<p>Adjust the signal levels to send to the monitor/auxiliary outputs, each of which corresponds to a separate monitoring mix. Each of these mixes are sent to separate channels on the P3T transmitter.</p> <p>Note: The channel faders on most mixers do not affect the volume of the monitor/auxiliary sends.</p>
<p>③ Wireless Transmission</p>	<p>Each monitoring mix is transmitted on a separate channel to the P3R receiver. The MixMode knob on the bodypack adjusts the blend between the audio from channel 1 and channel 2.</p>

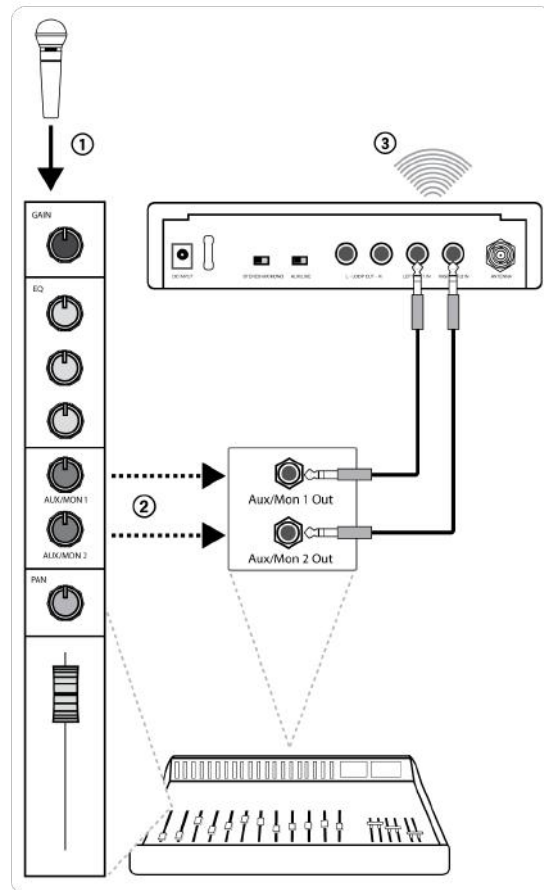

MixMode and Stereo Monitoring

The receiver can operate in stereo or MixMode when the transmitter is set to STEREO-MX. In applications that involve multiple bodypack receivers tuned to a single transmitter, some bodypacks can operate in stereo, while others operate in MixMode.

Selecting the Mode

Stereo: The receiver is set to stereo mode by default. To switch from MixMode to stereo, simply turn the receiver off and it will return to stereo mode when powered back on.

MixMode: Press and hold the GROUP button on the bodypack receiver while turning the power on. The MixMode indicator light on the receiver display turns on to confirm the setting. The receiver will return to stereo mode after it has been powered off.

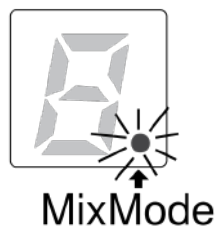

Stereo

Audio from channel 1 is heard on the left earphone, while audio from channel 2 is heard on the right earphone. Listening in stereo mode increases separation between the sources on each channel, which can improve clarity when many sources are being monitored. The MixMode knob on the bodypack adjusts left/right balance when operating in stereo mode.



MixMode

MixMode allows performers to adjust the blend between two monitoring mixes (an instrumental mix and a vocal mix, for example). When using MixMode:

- Each mix is heard through both the left and right earphones
- The MixMode knob adjusts the volume blend between the two monitor mixes (channel 1 and channel 2)
- Each bodypack receiver can dial in a unique blend to meet the monitoring needs of each performer

Adjusting mix levels

In this scenario, an instrumental mix is on channel 1 and a vocal mix is on channel 2:

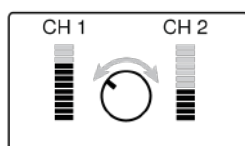

To hear more of channel one, turn the MixMode knob to the left.

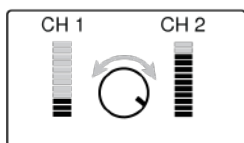

To hear more of channel two, turn the MixMode knob to the right.

When to Use the Mono Setting

In some cases, only a single input on the transmitter is used (if the mixer only features a single monitor/auxiliary output, for example). To ensure that audio is heard on both the left and right earphones:

- Use the LEFT/CH1 input on the transmitter
- Set the transmitter to MONO

Note: When the transmitter is set to mono operation, the MixMode knob will not affect the sound.

Troubleshooting

Problem	Solution
Distorted Audio	<p>Check the volume levels at the P3T transmitter and verify that the meter is not reaching the overload indicator</p> <p>Check levels going in and out of the mixer. If audio is distorting anywhere in the signal chain, it will be distorted even if the PSM300 system is not overloading.</p> <p>Make sure batteries in the receiver are fresh</p> <p>Verify that the cables are 1/4 inch balanced. If an unbalanced instrument or speaker cable is used, it may introduce noise.</p> <p><i>Tip: To tell the difference, look at the connectors on the cable. The metal connector on a balanced cable has two plastic rings that divide it into three separate sections (tip, ring, sleeve). An unbalanced cable only has a single plastic ring that divides the metal portion into two sections (tip, sleeve).</i></p> <p>Check that all cables are plugged all the way into the mixer and the P3T inputs. Sometimes, if a cable is not fully inserted, the signal will be faint and distorted.</p> <p>Make sure you are using the line-level outputs from the mixer. If you have a powered mixer, do not use the main speaker outputs, as they are amplified signals and will overload the P3T inputs.</p>
No sound from receiver	<p>Make sure the transmitter and receiver are linked to the same group and channel</p> <p>Verify levels are registering at the transmitter and that the volume is turned up on the receiver</p> <p>Check that the receiver is on and that the headphones are properly connected to the receiver</p>
Turning the Mix-Mode knob does not affect the sound	<p>The Stereo-MX/Mono switch on the rear panel of the P3T may be switched to mono. For the Mix-Mode knob to work, the transmitter must be set to Stereo-MX.</p> <p>Verify that the signals going from the mixer to the transmitter are not identical</p> <p>Check that the bodypack is set to MixMode</p>
Low audio output at the receiver	<p>Check headphone connection and volume level</p> <p>If only sending a single channel into the P3T transmitter, check if the MixMode knob isn't turned towards a silent channel. If using one channel, set the P3T transmitter to mono mode.</p>
Audio or RF drops out	<p>Perform a scan to ensure the receiver is on a clear (available) frequency</p> <p>Make sure there is a line-of-sight path between the transmitter antenna and the bodypack receivers</p> <p>Verify that other wireless devices that are being monitored, such as wireless microphones, are not experiencing RF dropouts</p> <p>If using an antenna other than the one included with the system, make sure it is designed to operate in the correct frequency range</p>
IR sync failure	<p>Verify distance between receiver and transmitter is between 6-11 cm</p>

Specifications

RF Carrier Range

488- 937.5 MHz

varies by region

Compatible Frequencies

Per band

up to 15

Tuning Bandwidth

24 MHz Maximum

Note: varies by region

Operating Range

environment dependent

90 m (300 ft)

Audio Frequency Response

38 Hz–15 kHz

Signal-To-Noise Ratio

A-Weighted

90 dB (typical)

Total Harmonic Distortion

ref. ± 34 kHz deviation @1 kHz

<0.5% (typical)

Companding

Patented Shure Audio Reference Companding

Spurious Rejection

ref. 12dB SINAD

>80 dB (typical)

Latency

<0.7 ms

Frequency Stability

± 2.5 ppm

MPX Pilot Tone

19 kHz (± 1 Hz)

Modulation

FM*, MPX Stereo

*ref. ± 34 kHz deviation @1 kHz

Operating Temperature

-18°C to +63°C

P3T

RF Output Power

10, 20, 30 mW

Note: varies by region

RF Output Impedance

50 Ω (typical)

Net Weight

783 g(27.6 oz.)

Dimensions

43 x 198 x 172 mm (1.7 x 7.8 x 6.8 in.), H x W x D

Power Requirement

12-15V DC, 260 mA Maximum

Audio Input

Connector Type

6.35 mm (1/4") TRS

Polarity

Tip positive with respect to ring

Configuration

Electronically balanced

Impedance

40 k Ω (actual)

Nominal Input Level

switchable: +4 dBu, -10 dBV

Maximum Input Level

+4 dBu	+22 dBu
-10 dBV	+12.2 dBu

Pin Assignments

Tip=hot, Ring=cold, Sleeve=ground

Phantom Power Protection

Up to 60 V DC

Audio Output

Connector Type

6.35 mm (1/4") TRS

Configuration

Electronically balanced

Impedance

Connected directly to inputs

P3R

Active RF Sensitivity

at 20 dB SINAD

2.2 μ V

Image Rejection

>90 dB

Adjacent Channel Rejection

>60 dB

Intermodulation Attenuation

>50 dB

Blocking

>60 dB

Audio Output Power

1kHz @ <1% distortion, peak power, @32 Ω

40 mW + 40 mW

Minimum Load Impedance

4 Ω

Headphone Output

3.5 mm (1/8") stereo

Output Impedance

<2.5 Ω

Net Weight

98 g(3.5 oz.) (without batteries)

Dimensions

110 x 64 x 21 mm H x W x D

Battery Life

5–7 hours (continuous use) AA batteries

Frequency Range and Transmitter Output Power

Frequency Range and Transmitter Output Level

Band	Range	Output Power
G20	488 to 512 MHz	30 mW
H8E	518 to 542 MHz	10 mW
H20	518 to 542 MHz	30 mW
H62	518 to 530 MHz	10 mW
J10	584 to 608 MHz	30 mW
J13	566 to 590 MHz	30 mW
JB	806 to 810 MHz	10 mW
K3E	606 to 630 MHz	30 mW
K12	614 to 638 MHz	30 mW
L18	630 to 654 MHz	10 mW
L19	630 to 654 MHz	30 mW
M16	686 to 710 MHz	30 mW
M18	686 to 710 MHz	10 mW
Q12	748 to 758 MHz	30 mW
Q25	742 to 766 MHz	30 mW
R12	794 to 806 MHz	10 mW
S8	823 to 832 MHz	20 mW
T11	863 to 865 MHz	10 mW
X7	925 to 937.5	10 mW

Note: Frequency bands might not be available for sale or authorized for use in all countries or regions.

NOTE: This Radio equipment is intended for use in musical professional entertainment and similar applications. This Radio apparatus may be capable of operating on some frequencies not authorized in your region. Please contact your national authority to obtain information on authorized frequencies and RF power levels for wireless microphone products.

Optional Accessories and Replacement Parts

Bodypack receiver	P3R
Half-rack Transmitter	P3T
Universal bodypack receiver	P3RA
Antenna and power distribution system	PA411
Wired PSM bodypack	P9HW
Dynamic MicroDriver earphones	SE112
Dynamic MicroDriver earphones	SE215
High-definition MicroDriver earphones with tuned bass port	SE315
High-definition earphones with dual MicroDrivers	SE425
High-definition earphones with triple MicroDrivers	SE535
High-definition earphones with quad MicroDrivers	SE846
Carrying/Storage Bag	95A2313
1/4 Wave Antenna (748–865 MHz) for SLX Wireless System	UA400
1/4 wave antenna (470-752 MHz)	UA400B
Single Rack Mount Kit	RPW503
Dual Rack Mount Kit	RPW504

Frequencies for European Countries

H8E 518-542 MHz

Country Code	Frequency Range
Code de Pays	Gamme de frequences
Codice di paese	Gamme di frequenza
Código de país	Gama de frecuencias
Länder-Kürzel	Frequenzbereich
A, B, BG, CH, CY, CZ, D, EST	518 - 542 MHz*
F, GB, GR, H, I, IS, L, LT	518 - 542 MHz*

Country Code	Frequency Range
Code de Pays	Gamme de frequences
Codice di paese	Gamme di frequenza
Código de país	Gama de frecuencias
Länder-Kürzel	Frequenzbereich
NL, P, PL, S, SK, SLO	518 - 542 MHz*
DK, FIN, M, N	*
HR, E, IRL, LV, RO, TR	*

* This equipment may be capable of operating on some frequencies not authorized in your region. See [Licensing Information](#).

H20 518-542 MHz

Country Code	Frequency Range
Code de Pays	Gamme de frequences
Codice di paese	Gamme di frequenza
Código de país	Gama de frecuencias
Länder-Kürzel	Frequenzbereich
A, B, BG, CH, CY, CZ, D, DK, EST, F	518 - 542 MHz*
FIN, GB, GR, H, HR, I, IRL, IS, L, LT	518 - 542 MHz*
M, N, NL, P, PL, RO, S, SK, SLO, TR	518 - 542 MHz*
all other countries	*

* This equipment may be capable of operating on some frequencies not authorized in your region. See [Licensing Information](#).

K3E 606-630 MHz

Country Code	Frequency Range
Code de Pays	Gamme de frequences
Codice di paese	Gamme di frequenza
Código de país	Gama de frecuencias
Länder-Kürzel	Frequenzbereich
A, B, BG, CH, CY, CZ, D, EST	606 - 630 MHz*

Country Code	Frequency Range
Code de Pays	Gamme de frequences
Codice di paese	Gamme di frequenza
Código de país	Gama de frecuencias
Länder-Kürzel	Frequenzbereich
F, GB, GR, H, I, IRL, L, LT	606 - 630 MHz*
NL, P, PL, S, SK, SLO	606 - 630 MHz*
DK, FIN, M, N	*
HR, E, IRL, LV, RO, TR	*

* This equipment may be capable of operating on some frequencies not authorized in your region. See [Licensing Information](#).

K12 614-638 MHz

Country Code	Frequency Range
Code de Pays	Gamme de frequences
Codice di paese	Gamme di frequenza
Código de país	Gama de frecuencias
Länder-Kürzel	Frequenzbereich
A, B, BG, CH, CY, CZ, D, DK, EST, F	614 - 638 MHz*
FIN, GB, GR, H, HR, I, IRL, IS, L, LT	614 - 638 MHz*
M, N, NL, P, PL, RO, S, SK, SLO, TR	614 - 638 MHz*
all other countries	*

* This equipment may be capable of operating on some frequencies not authorized in your region. See [Licensing Information](#).

M16 686-710 MHz

Country Code	Frequency Range
Code de Pays	Gamme de frequences
Codice di paese	Gamme di frequenza
Código de país	Gama de frecuencias
Länder-Kürzel	Frequenzbereich
A, B, BG, CH, CY, CZ, D, DK, EST, F	686 - 710 MHz*
FIN, GB, GR, H, HR, I, IRL, IS, L, LT	686 - 710 MHz*
M, N, NL, P, PL, RO, S, SK, SLO, TR	686 - 710 MHz*
all other countries	686 - 710 MHz*

* This equipment may be capable of operating on some frequencies not authorized in your region. See [Licensing Information](#).

R12 796-806 MHz

Country Code	Frequency Range
Code de Pays	Gamme de frequences
Codice di paese	Gamme di frequenza
Código de país	Gama de frecuencias
Länder-Kürzel	Frequenzbereich
N	796 - 806 MHz*
A, B, BG, CH, CY, CZ, D, DK, E, EST	*
F, FIN, GB, GR, H, HR, I, IRL, IS, L, LT	*
LV, M, NL, P, PL, S, SK, SLO, TR	*

* This equipment may be capable of operating on some frequencies not authorized in your region. See [Licensing Information](#).

S8 823-832 MHz

Country Code Code de Pays Codice di paese Código de país Länder-Kürzel	Frequency Range Gamme de frequences Gamme di frequenza Gama de frecuencias Frequenzbereich
BG, CH, D, DK, EST, F, FIN, IS, N, NL, S	license free*
A, B, CY, CZ	*
E, GB, GR, H, HR	*
I, IRL, LV, L, LT, M, P, PL	*
SK, SLO, RO, TR	*

* This equipment may be capable of operating on some frequencies not authorized in your region. See [Licensing Information](#).

T11 863-865 MHz

Country Code Code de Pays Codice di paese Código de país Länder-Kürzel	Frequency Range Gamme de frequences Gamme di frequenza Gama de frecuencias Frequenzbereich
A, B, BG, CH, CY, CZ, D, DK, E, EST	license free
F, FIN, GB, GR, H, HR, I, IRL, IS, L, LT	license free
LV, M, N, NL, P, PL, S, SK, SLO	license free
TR	863 - 865 MHz*

* This equipment may be capable of operating on some frequencies not authorized in your region. See [Licensing Information](#).

Q25 614-638 MHz

Country Code	Frequency Range
Code de Pays	Gamme de frequences
Codice di paese	Gamme di frequenza
Código de país	Gama de frecuencias
Länder-Kürzel	Frequenzbereich
A, B, BG, CH, CY, CZ, D, EST	742 - 766 MHz*
F, GB, GR, H, I, IS, L, LT	742 - 766 MHz*
NL, P, PL, S, SK, SLO	742 - 766 MHz*
RO	742 - 743; 750 - 751; 758 - 759 MHz*
HR, E, IRL, LV, TR, DK, RIN, M, N	*

* This equipment may be capable of operating on some frequencies not authorized in your region. See [Licensing Information](#).

Certifications

Industry Canada ICES-003 Compliance Label: CAN ICES-3 (B)/NMB-3(B)

Complies with requirements set out in RSS-GEN.

Certified by ISED in Canada under RSS-123 and RSS-102.

Certified by ISED in Canada under RSS-102 and RSS-210.

IC: 616A-P3TT.

IC: 616A-P3TA, 616A-P3TB, 616A-P3TD.

FCC: DD4P3TA, DD4P3TB, DD4P3TD, DD4P3TT.

Approved under the Declaration of Conformity (DoC) provision of FCC Part 15.

Certified under FCC Part 74.

Important Product Information

CE Notice:

Hereby, Shure Incorporated declares that this product with CE Marking has been determined to be in compliance with European Union requirements. The full text of the EU declaration of conformity is available at the following site: <https://www.shure.com/en-EU/support/declarations-of-conformity>.

Authorized European Importer / Representative:

Shure Europe GmbH
 Department: Global Compliance
 Jakob-Dieffenbacher-Str. 12
 75031 Eppingen, Germany

Phone: +49-7262-92 49 0
 Fax: +49-7262-92 49 11 4
 Email: EMEAsupport@shure.de

UKCA Notice:

Hereby, Shure Incorporated declares that this product with UKCA Marking has been determined to be in compliance with UK-CA requirements. The full text of the UK declaration of conformity is available at the following site: <https://www.shure.com/en-GB/support/declarations-of-conformity>.

Authorized UK Importer / Representative:

Shure UK Limited
 Unit 2, The IO Centre, Lea Road,
 Waltham Abbey, Essex, EN9 1 AS, UK

เครื่องโทรคมนาคมและอุปกรณ์นี้มีความสอดคล้องตามมาตรฐานหรือข้อกำหนดทางเทคนิคของ กสทช.

- (一) 本产品符合“微功率短距离无线电发射设备目录和技术要求”的具体条款和使用场景；
- (二) 不得擅自改变使用场景或使用条件、扩大发射频率范围、加大发射功率（包括额外加装射频功率放大器），不得擅自更改发射天线；
- (三) 不得对其他合法的无线电台（站）产生有害干扰，也不得提出免受有害干扰保护；
- (四) 应当承受辐射射频能量的工业、科学及医疗（ISM）应用设备的干扰或其他合法的无线电台（站）干扰；
- (五) 如对其他合法的无线电台（站）产生有害干扰时，应立即停止使用，并采取措施消除干扰后方可继续使用；
- (六) 在航空器内和依据法律法规、国家有关规定、标准划设的射电天文台、气象雷达站、卫星地球站（含测控、测距、接收、导航站）等军民用无线电台（站）、机场等的电磁环境保护区域内使用微功率设备，应当遵守电磁环境保护及相关行业主管部门的规定。

低功率射頻器材技術規範

取得審驗證明之低功率射頻器材，非經核准，公司、商號或使用者均不得擅自變更頻率、加大功率或變更原設計之特性及功能。低功率射頻器材之使用不得影響飛航安全及干擾合法通信；經發現有干擾現象時，應立即停用，並改善至無干擾時方得繼續使用。前述合法通信，指依電信管理法規定作業之無線電通信。低功率射頻器材須忍受合法通信或工業、科學及醫療用電波輻射性電機設備之干擾。

Information to the user

This equipment has been tested and found to comply with the limits for a Class B digital device, pursuant to part 15 of the FCC Rules. This equipment generates, uses, and can radiate radio frequency energy and, if not installed and used in accordance with the manufacturer's instruction manual, may cause interference with radio and television reception.

Notice: The FCC regulations provide that changes or modifications not expressly approved by Shure Incorporated could void your authority to operate this equipment.

These limits are designed to provide reasonable protection against harmful interference in a residential installation. This equipment generates uses and can radiate radio frequency energy and, if not installed and used in accordance with the instructions, may cause harmful interference to radio communications. However, there is no guarantee that interference will not occur in a particular installation. If this equipment does cause harmful interference to radio or television reception, which can be determined by turning the equipment off and on, the user is encouraged to try to correct the interference by one or more of the following measures:

- Reorient or relocate the receiving antenna.
- Increase the separation between the equipment and the receiver.
- Connect the equipment to an outlet on a circuit different from that to which the receiver is connected.

- Consult the dealer or an experienced radio/TV technician for help.

This device complies with part 15 of the FCC Rules. Operation is subject to the following two conditions:

1. This device may not cause harmful interference.
2. This device must accept any interference received, including interference that may cause undesired operation.

Note: EMC conformance testing is based on the use of supplied and recommended cable types. The use of other cable types may degrade EMC performance.

Changes or modifications not expressly approved by the manufacturer could void the user's authority to operate the equipment.

Please follow your regional recycling scheme for batteries, packaging, and electronic waste.

Canada Warning for Wireless

This device operates on a no-protection, no-interference basis. Should the user seek to obtain protection from other radio services operating in the same TV bands, a radio licence is required. For further details, consult Innovation, Science and Economic Development Canada's document Client Procedures Circular CPC-2-1-28, Voluntary Licensing of Licence-Exempt Low-Power Radio Apparatus in the TV Bands.

Ce dispositif fonctionne selon un régime de non-brouillage et de non-protection. Si l'utilisateur devait chercher à obtenir une certaine protection contre d'autres services radio fonctionnant dans les mêmes bandes de télévision, une licence radio serait requise. Pour en savoir plus, veuillez consulter la Circulaire des procédures concernant les clients CPC-2-1-28, Délivrance de licences sur une base volontaire pour les appareils radio de faible puissance exempts de licence et exploités dans les bandes de télévision d'Innovation, Sciences et Développement économique Canada.

This device contains licence-exempt transmitter(s)/receiver(s) that comply with Innovation, Science and Economic Development Canada's licence-exempt RSS(s). Operation is subject to the following two conditions:

1. This device may not cause interference.
2. This device must accept any interference, including interference that may cause undesired operation of the device.

L'émetteur/récepteur exempt de licence contenu dans le présent appareil est conforme aux CNR d'Innovation, Sciences et Développement économique Canada applicables aux appareils radio exempts de licence. L'exploitation est autorisée aux deux conditions suivantes :

1. L'appareil ne doit pas produire de brouillage;
2. L'appareil doit accepter tout brouillage radioélectrique subi, même si le brouillage est susceptible d'en compromettre le fonctionnement.

The antenna(s) must be installed such that a minimum separation distance of 20 cm is maintained between the radiator (antenna) and all persons at all times.

La ou les antennes doivent être installées de telle façon qu'une distance de séparation minimum de 20 cm soit maintenue entre le radiateur (antenne) et toute personne à tout moment.

Australia Warning for Wireless

This device operates under an ACMA class licence and must comply with all the conditions of that licence including operating frequencies. Before 31 December 2014, this device will comply if it is operated in the 520-820 MHz frequency band.

WARNING: After 31 December 2014, in order to comply, this device must not be operated in the 694-820 MHz band.

LICENSING INFORMATION

Licensing: A ministerial license to operate this equipment may be required in certain areas. Consult your national authority for possible requirements. Changes or modifications not expressly approved by Shure Incorporated could void your authority to operate the equipment. Licensing of Shure wireless microphone equipment is the user's responsibility, and licensability de-

depends on the user's classification and application, and on the selected frequency. Shure strongly urges the user to contact the appropriate telecommunications authority concerning proper licensing, and before choosing and ordering frequencies.