

# SHURE®

LEGENDARY  
PERFORMANCE™

## ULX Wireless System



**Shure ULX Wireless**

**ULX sans fil de Shure**

**Sistema inalámbrico ULX de Shure**

**Sistema ULX Sem Fio da Shure**

©2014 Shure Incorporated  
27A15788 (Rev. 4)



CE

# ULX System Components

All systems include either a ULXS4 Standard Diversity Receiver or ULXP4 Professional Diversity Receiver.

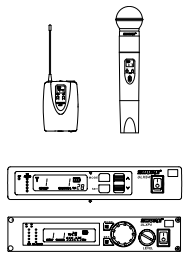

Bodypack systems include a choice of lavalier, headworn, or instrument microphones.

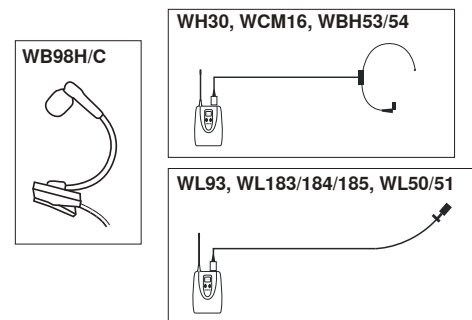

Handheld systems include a choice of interchangeable microphone heads.

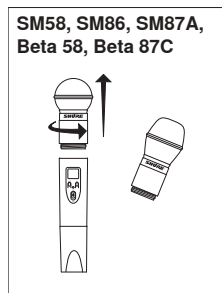

Guitar systems include a 1/4" to mini 4-pin cable.

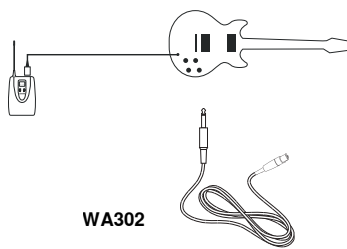

ULXP4 receivers include rack-mounting hardware.

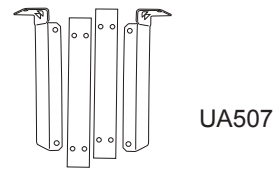

FULL RACK MOUNT HARDWARE

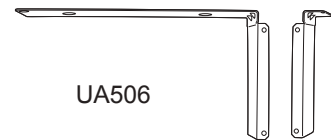

1/2 RACK MOUNT HARDWARE

## Antennas

### Active Antennas

The antenna connectors on the ULX receiver provide 12 V DC for active circuit antennas.

Caution: Use only Shure antenna accessories to ensure the best operation. Do not use splitters, combiners, or antennas that provide a DC ground, as this can cause the receiver to function improperly.

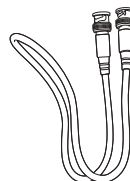
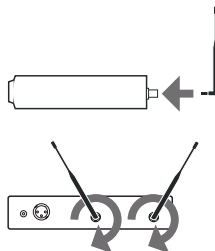

Coaxial Cables

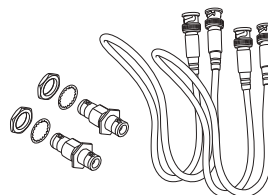

Front Mount Antenna Kit



1/2-Wave Antenna included with ULXP4 systems

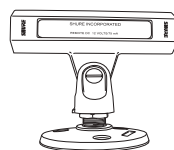

Inline Antenna Amplifier for long antenna cable runs

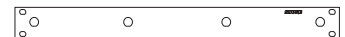

Antenna Rack Mount Kit

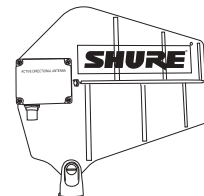

Active Directional Antenna for more focused reception

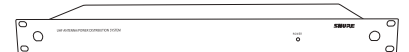

Distribution Amplifier combines antennas and power supplies for multiple receivers

### Antenna Combiners and Accessories

The supplied antennas can be connected directly to the BNC-type ANTENNA connectors. However, optional antenna mounting accessories from Shure can improve reception and reduce rack clutter. Use the following guidelines:

- Antennas and receivers must be from the same band.
- Mount antennas more than 40 cm (16 inches) apart.
- Use Shure UA825 or UA850 low-loss coaxial antenna cable (or any 50 ohm, low-loss cable such as RG-8U).

Visit [www.shure.com](http://www.shure.com) for more information on wireless antenna accessories.

## Rack Installation

### ULXP4

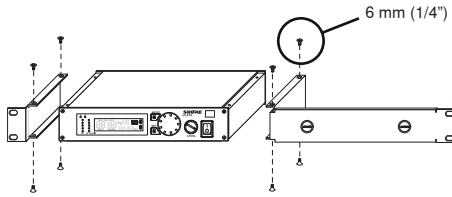

### ULXP4 DUAL

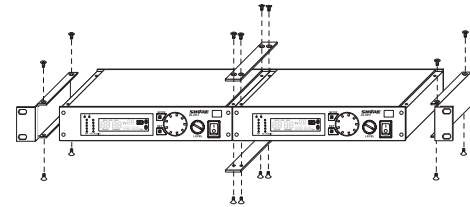

## Rackmount Options

The following shows rackmounting options for one to four receivers and lists the required accessories.

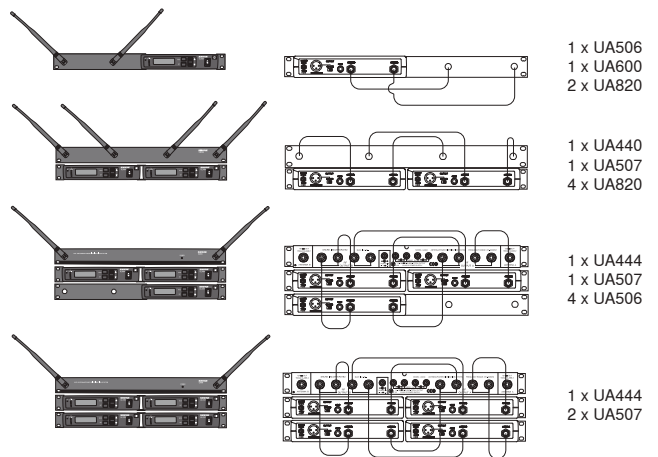

## Power

### ULXP4, ULXS4

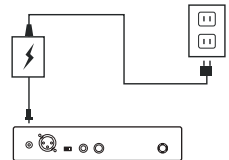

### Power switch

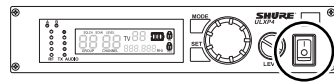

### Power Connector



Connect using the supplied AC adapter or certified 14–18 Vdc (550 mA) replacement supply.

## Batteries

### Installation

#### ULX1, ULX2

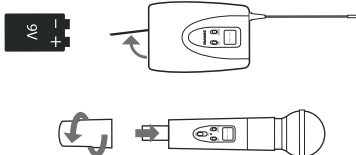

- Batteries stored for more than a year or stored in excessively hot environments may experience a higher failure rate.
- Do not use rechargeable batteries with a fully-charged rating of greater than 9 V (for example, 9.6 V).
- Transmitters require a minimum of 6 V to operate.

### Power Indicator (BAT)

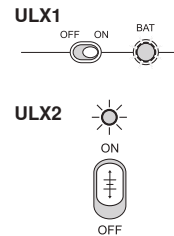

**Green:** ready  
**Red:** battery power low

Note: Remaining battery life varies with battery type.

### Battery Life

Use only 9V alkaline or lithium batteries. Typical life for common types of 9V batteries are listed below. For detailed information on battery performance, contact Shure Applications Engineering.

Recommended:

- Lithium (16 hours)
- Alkaline (8 hours)

Not recommended:

- Carbon-Zinc (½ hour)
- Rechargeable Ni-Cd (2 hours)
- Rechargeable Ni-MH (2½ hours)

Note:

- Battery life varies with type and manufacturer.

### Power/Mute Switch

- Turn transmitter off to mute the microphone or conserve battery power.
- Use the lock feature to avoid accidental muting of the microphone during a performance.

### Battery Indicator

#### ULX1, ULX2

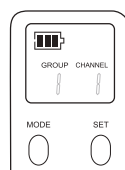

#### ULXP4, ULXS4



Battery Level	Hours
Full (4 bars)	≈ 6–8
3/4 (3 bars)	≈ 2–6
1/2 (2 bars)	≈ 0–2
Empty (0 bars)	= 0

Both the transmitter and receiver LCD shows approximate operation time remaining for the transmitter.

# Single System

If you encounter wireless interference, perform a channel scan on the receiver and use the selected channel. You usually do not need to change the group.

# Multiple Systems

To maximize performance, set all wireless systems to different channels from the same group. These channels are selected to work well together.

Follow these steps when using group and channel scan with multiple systems.

1. Power off all system transmitters. Turn on all other wireless or digital devices as they would be during the performance or presentation.
2. **On the first receiver:** Perform a group scan. Note the selected group, then use channel scan to find the first open channel in that group.
3. Power on the first transmitter and set it to the selected group and channel.
4. **IMPORTANT:** Leave the first transmitter powered on while setting up the next system.

5. **For each additional system:** Set to the same group as the first. Perform a channel scan and set the receiver and transmitter to the selected channel.
6. Leave each transmitter on while setting up additional systems.

**Note:**

- Keep each transmitter at least two meters (6 feet) apart.
- If using systems from different bands, set up all systems from the same band together.

**Tip:** To reduce setup time, you can manually set up the group and channels before arriving at the venue. Visit [www.shure.com](http://www.shure.com) for a list of groups and channels that are anticipated to be free of interference in a particular city or region.

# Automatic Frequency Scan

## Channel Scan

This feature scans for an open channel in the selected group.

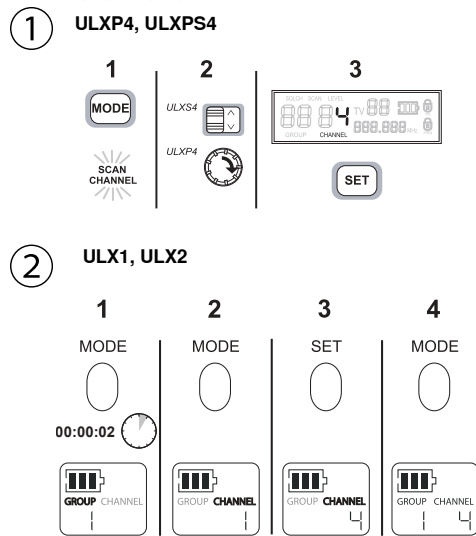

## Group Scan (ULXP4 only)

The "group scan" feature on the ULXP helps maximize the number of systems you can install at a single venue. It scans for wireless interference and finds the group with the most open channels.

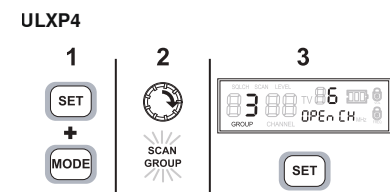

# Changing Group and Channel

If you encounter wireless interference, set the receiver and transmitter to a different channel or group.

## Change Channel

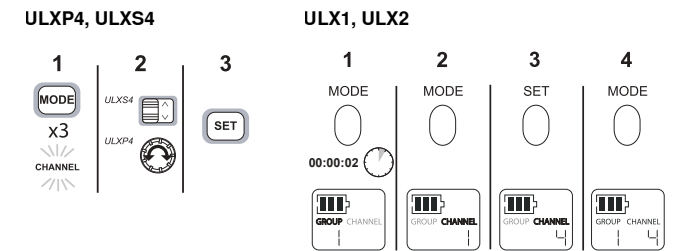

## Change Group

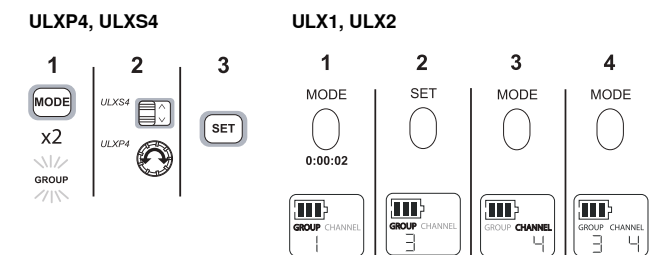

\* **Note:** You can reverse the scroll direction by holding SET and pressing MODE.

# Wireless Indicators

## RF Indicator

Indicates wireless activity over the selected channel.

**Note:** When the antenna and battery indicators are illuminated, the RF indicator shows signal strength from the transmitter. Otherwise, it is showing interference from another source. Select a different channel.

ULXP4      ULXS4



## Antenna Indicator

This indicator shows which antenna is receiving the strongest signal from the transmitter.

ULXP4      ULXS4



## Frequency Display

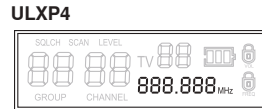

## TV

For models sold in the United States only. Displays the TV channel occupied by the selected frequency.

ULXP4, ULXPS4

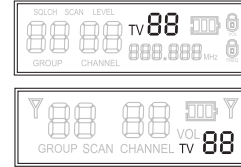

# Frequency Master List Mode

Master List mode offers more precise frequency selection for larger, multiple-system installations.

Enter Master List mode on the receiver or transmitter by holding down the SET button for 10 seconds. Set GROUP and CHANNEL as you would in normal mode.

**Note:** The unit must remain in Master List mode to operate at the selected frequency.

Exit Master List mode by holding the SET button for 10 seconds.

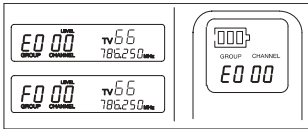

# Squelch

The factory setting offers the optimum performance for most installations.

Increasing squelch filters out all but the highest quality signal, but this decreases operating range. Decreasing squelch extends the operating range, but can increase signal noise.

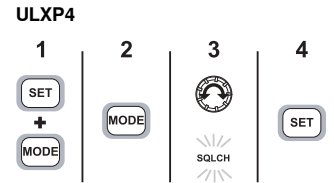

# Audio Output

## Audio Output Connectors

**Balanced XLR:** Connect to a mixer or other professional audio input. Use the MIC/LINE switch to adjust for microphone or line-level inputs.

**Unbalanced 6.35 mm (1/4"):** Connect to high impedance inputs, such as a guitar amplifier.

**Note:** The LINE/MIC switch does not affect the 6.35 mm (1/4") jack.



LOW Z

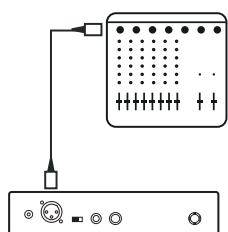

HIGH Z

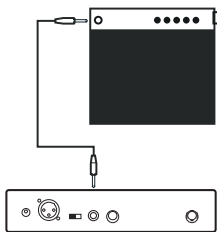

# Receiver Output Level

Adjusts the level of the receiver's audio outputs.

ULXP4

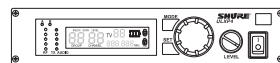

# PEAK Icon

This icon appears when the input signal overloads the transmitter. The icon is displayed for 2 seconds after input overload is detected.

ULX1, ULX2

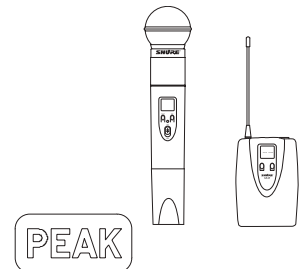

# Transmitter Gain

For best audio quality, adjust transmitter gain so only the green and yellow TXAUDIO LEDs flicker. (Occasional illumination of the red LED is okay.)

- Green** = nominal
- Yellow** = peak
- Red** = overload

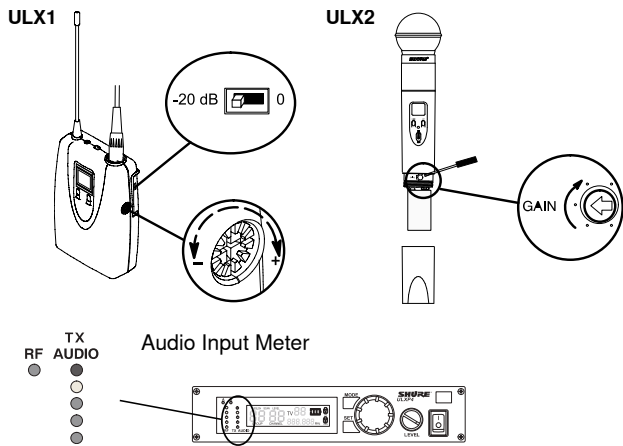

## ULX1

1. Set the attenuator (pad) switch to 0 dB for microphones and -20 dB for guitars. (Some low output instruments may not need attenuation.)
2. Adjust gain control as necessary.

## ULX2

- Fully clockwise for quiet to normal vocal performance.
- Halfway counterclockwise for loud vocal performance.
- Fully counterclockwise for horn or percussive instruments.

# Locking the Receiver (ULXP4 Only)

This feature prevents accidental setting changes.

## ULXP4

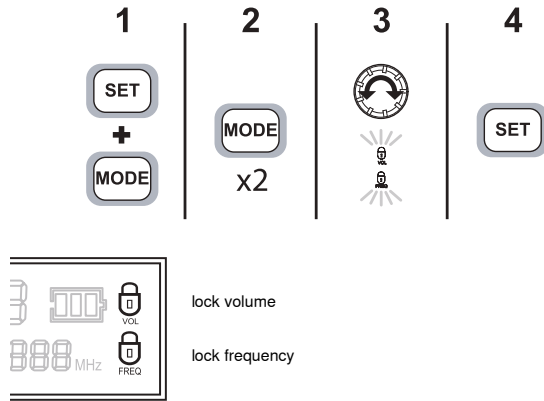

## Unlocking

Hold the SET button while turning the control wheel left, right, left.

## ULXP4

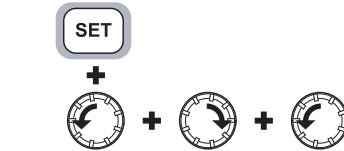

**Note:** If LEVEL flashes on the LCD, decrease the LEVEL control to continue. This feature safeguards against sudden level increases when the lock is removed.

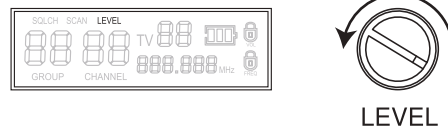

# Locking the Transmitter

## Lock/Unlock Power (On)

Hold SET and MODE for four seconds or until the lock icon appears.

### ULX1, ULX2

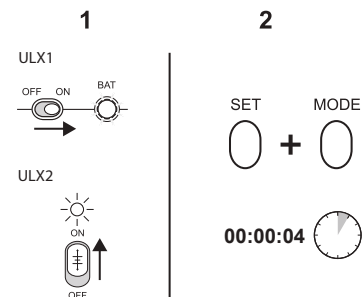

- Po L** power lock
- Po UL** power unlock

## Lock/Unlock Frequency

Hold the SET button while powering on the transmitter.

### ULX1, ULX2

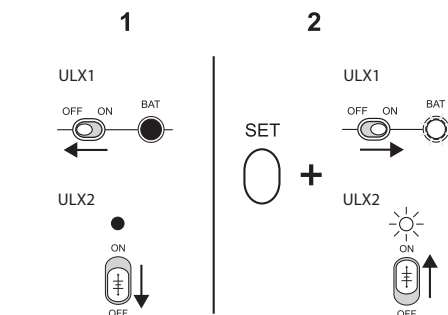

- Fr L** frequency lock
- Fr UL** frequency unlock

# Troubleshooting

**No power:** Check battery and power supply connections and voltage. Check the power switch on the transmitter.

**The LCD displays "E0 00" or similar code:** Exit master list mode by holding the SET button for ten seconds.

**Can't turn off or change settings on the transmitter or receiver:** The interface is locked. See the section on locking the interface.

**No audio:** If the antenna and battery indicators do not appear on the receiver, then it is not receiving a signal from the transmitter. Make sure the transmitter and receiver are tuned to the same group and channel.

**Faint or distorted audio:** Adjust transmitter gain, bodypack attenuator switch, and receiver output level.

**Noise:** Noise usually results from wireless interference or a weak signal from the transmitter. See Tips for Improving System Performance.

# Tips for Improving System Performance

If you encounter wireless interference or dropouts, try the following:

- Replace the transmitter battery with a fresh alkaline battery (avoid rechargeable batteries).
- Choose a different frequency channel.
- Reposition the antennas so there is nothing obstructing a line of sight to the transmitter (including the audience).
- Avoid placing transmitter and receiver where metal or other dense materials may be present.
- Move the receiver to the top of the equipment rack (or remote mount antennas outside the rack).
- Remove nearby sources of wireless interference, such as cell phones, two-way radios, computers, media players, and digital signal processors.
- Keep transmitters more than two meters (6 feet) apart.
- Keep the transmitter and receiver more than 5 meters (15 ft) apart.
- Point the receiver antenna tips away from each other at a 45° angle, and keep them away from large metal objects.
- During sound check, mark "trouble spots" and ask presenters or performers to avoid those areas.

# Parts and Accessories

## Included Accessories

Microphone Stand Adapter (ULX2)	WA371
Grip/Switch Cover (ULX2)	WA555
Zipper Bag (ULX1)	95A2313
Zipper Bag (ULX2)	95B2313
Screwdriver (ULX2)	80A498

## Optional Accessories

Passive Antenna Splitter/Combiner Kit	UA221
UHF Line Amplifier	UA830WB
UHF Powered Directional Antenna	UA874US
	UA874E
	UA874WB
	UA874X
UHF Antenna Power Distribution Amplifier (U.S.A.)	UA844SWB
UHF Antenna Power Distribution Amplifier (Europe)	UA844SWB-E
UHF Antenna Power Distribution Amplifier (UK)	UA844SWB-UK
33 m (100 ft.) BNC-BNC cable	UA8100
1.8 m (6 ft.) BNC-BNC cable	UA806
Antenna Rack Panel	UA440
Front Mount Antenna Kit (Includes 2 cables and 2 bulkhead adapters)	UA600
Remote Antenna Bracket with BNC Bulkhead Adapter	UA505
Rack Mount Kit for single Receiver	UA506
Rack Mount Kit for Two Receivers	UA507
Carrying Case	WA610
Microphone Adapter Cable (XLR)	WA310

## Replacement Parts

AC Adapter (120 VAC, 60 Hz)	PS41
AC Adapter (220 VAC, 50 Hz)	PS41AR
AC Adapter (230 VAC, 50/60 Hz)	PS41AZ
AC Adapter (230 VAC, 50/60 Hz, Europlug)	PS41E
AC Adapter (230 VAC, 50/60 Hz)	PS41UK
AC Adapter (100 VAC, 50/60 Hz)	PS41J
SM58 Cartridge with Grille (ULX2/58)	RPW112
BETA 58A Cartridge with Grille (ULX2/ BETA 58)	RPW118
SM86 Cartridge with Grille (ULX2/SM86)	RPW114
SM87A Cartridge with Grille (ULX2/87)	RPW116
BETA 87A Cartridge with Grille (ULX2/BETA 87A)	RPW120
BETA 87C Cartridge with Grille (ULX2/BETA 87C )	RPW122
Matte Silver Grille for SM58	RK143G
Matte Silver Grille for SM86	RPM226
Matte Silver Grille for BETA 58A	RK265G
Matte Silver Grille for BETA 87A	RK312
Black Grille for SM87A	RK214G
Black Grille for BETA 58A	RPM323G
Black Grille for BETA 87A and BETA 87C	RPM324G
Belt Clip	44A8013A
1/4-Wave Antenna (470 - 752 MHz)	UA400B
1/4-Wave Antenna (774 - 952 MHz)	UA400
1/2-Wave Antenna (774 - 865 MHz)	UA8-774-865
1/2-Wave Antenna (638 - 698 MHz)	UA8-638-698
1/2-Wave Antenna (554 - 590 MHz)	UA8-554-590
1/2-Wave Antenna (740 - 814 MHz)	UA8-740-814
1/2-Wave Antenna (470 - 530 MHz)	UA8-470-530
1/2-Wave Antenna (746 - 784 MHz)	UA8-746-784
1/2-Wave Antenna (572 - 596 MHz)	UA8-572-596
1/2-Wave Antenna (578 - 638 MHz)	UA8-578-638

## Certifications

This Class B digital apparatus complies with Canadian ICES-003. Cet appareil numérique de la classe B est conforme à la norme NMB-003 du Canada.

This product meets the Essential Requirements of all relevant European directives and is eligible for CE marking.

The CE Declaration of Conformity can be obtained from: [www.shure.com/europe/compliance](http://www.shure.com/europe/compliance)

Authorized European representative:  
Shure Europe GmbH  
Headquarters Europe, Middle East & Africa  
Department: EMEA Approval  
Jakob-Dieffenbacher-Str. 12  
75031 Eppingen, Germany  
Phone: 49-7262-92 49 0  
Fax: 49-7262-92 49 11 4  
Email: [EMEAsupport@shure.de](mailto:EMEAsupport@shure.de)

### ULX1, ULX2

Certified under FCC Part 74.

Certified by IC in Canada under RSS-123 and RSS-102.

**FCC ID:** DD4ULX1, DD4ULX2, DD4ULX1G3, DD4ULX2G3. **IC:** 616A-ULX1, 616A-ULX2.

### ULXS4, ULXP4

Approved under the Declaration of Conformity (DoC) provision of FCC Part 15.

Certified in Canada by IC to RSS-123.

## Important Product Information

### LICENSING INFORMATION

Licensing: A ministerial license to operate this equipment may be required in certain areas. Consult your national authority for possible requirements. Changes or modifications not expressly approved by Shure Incorporated could void your authority to operate the equipment. Licensing of Shure wireless microphone equipment is the user's responsibility, and licensability depends on the user's classification and application, and on the selected frequency. Shure strongly urges the user to contact the appropriate telecommunications authority concerning proper licensing, and before choosing and ordering frequencies.

### Information to the user

This equipment has been tested and found to comply with the limits for a Class B digital device, pursuant to Part 15 of the FCC Rules. These limits are designed to provide reasonable protection against harmful interference in a residential installation. This equipment generates uses and can radiate radio frequency energy and, if not installed and used in accordance with the instructions, may cause harmful interference to radio communications. However, there is no guarantee that interference will not occur in a particular installation. If this equipment does cause harmful interference to radio or television reception, which can be determined by turning the equipment off and on, the user is encouraged to try to correct the interference by one or more of the following measures:

- Reorient or relocate the receiving antenna.
- Increase the separation between the equipment and the receiver.
- Connect the equipment to an outlet on a circuit different from that to which the receiver is connected.
- Consult the dealer or an experienced radio/TV technician for help.

**Note:** EMC conformance testing is based on the use of supplied and recommended cable types. The use of other cable types may degrade EMC performance.

Please follow your regional recycling scheme for batteries, packaging, and electronic waste.

**WARNING:** This product contains a chemical known to the State of California to cause cancer and birth defects or other reproductive harm.

### Australia Warning for Wireless

This device operates under an ACMA class licence and must comply with all the conditions of that licence including operating frequencies. Before 31 December 2014, this device will comply if it is operated in the 520-820 MHz frequency band. **WARNING:** After 31 December 2014, in order to comply, this device must not be operated in the 694-820 MHz band.

## Wiring Diagram

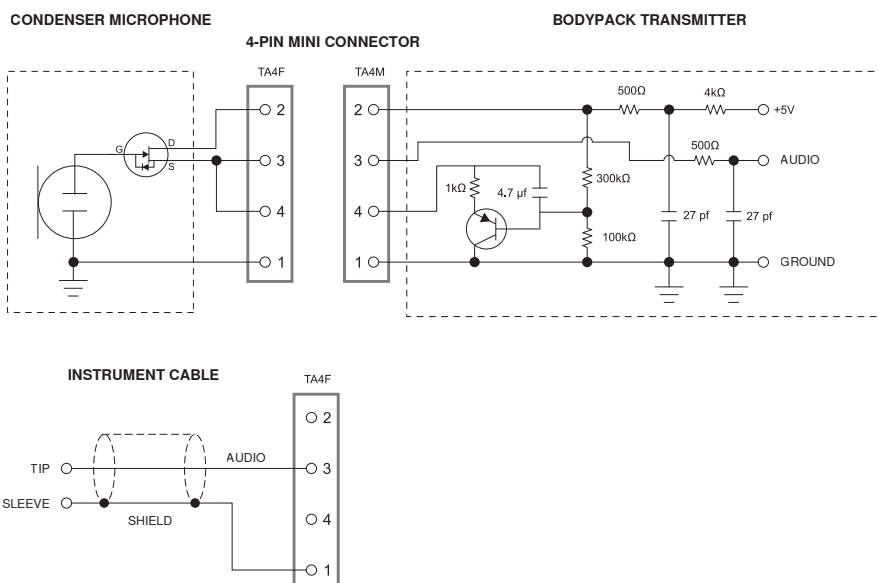



# Specifications

## RF Carrier Range

470,000–865,000 MHz

varies by region

## Working Range

100 m (300 ft) typical

Note: Actual range depends on RF signal absorption, reflection and interference.

## Audio Frequency Response

25 Hz – 15 kHz,  $\pm 2$  dB

Note: Dependent on microphone type

## Modulation

$\pm 38$  kHz deviation compressor-expander system with pre- and de-emphasis

## Dynamic Range

>100 dB, A-weighted

## Image Rejection

80 dB, typical

## RF Sensitivity

1.26  $\mu$ V for 12 dB SINAD, typical

## Spurious Rejection

75 dB, typical

## Ultimate Quieting

Ref.  $\pm 38$  kHz deviation with 1 kHz tone

>105 dB, A-Weighted

## Total Harmonic Distortion

Ref.  $\pm 38$  kHz deviation with 1 kHz tone

0.3%, typical

## Operating Temperature Range

-20°C (-4°F) to 49°C (120°F)

Note: Battery characteristics may limit this range.

## Polarity

Positive pressure on microphone diaphragm (or positive voltage applied to tip of WA302 phone plug) produces positive voltage on pin 2 (with respect to pin 3 of low-impedance output) and the tip of the high impedance 1/4-inch output.

## Battery Life

8 to 9 hours (9 V alkaline)

## ULX1

### Gain Adjustment Range

25 dB

### Attenuation Switch

0, -20 dB

### Dimensions

96.5 x 67 x 26.7 mm (3.86 x 2.68 x 1.10 in.), H x W x D

### Weight

79 g (2.8 oz.) without batteries

### Power Requirements

9 V alkaline

### Input Impedance

1 M $\Omega$

### RF Output Power

30 mW maximum

varies by region

## Transmitter Input

### Connector

4-Pin male mini connector (TA4M)

### Configuration

Unbalanced, active

### Impedance

Microphone	75 k $\Omega$
WA302	1 M $\Omega$

### Maximum Input Level

1 kHz at 1% THD

Microphone	-4 dBV (1.82 Vp-p)	
WA302	PAD OFF (0dB)	5 dBV (5 Vp-p)
	PAD ON (-20dB)	25 dBV (50 Vp-p)

### Pin Assignments

TA4M

1	ground (cable shield)
2	+ 5 V Bias
3	audio
4	Tied through active load to ground (On instrument adapter cable, pin 4 floats)

## ULX2

### Gain Adjustment Range

20 dB

### Dimensions

SM58	229 x 51 mm (9 x 2 in.), L x Dia.
BETA 58	221 x 51 mm (8.7 x 2 in.), L x Dia.
SM86	213 x 49 mm (8.4 x 1.9 in.), L x Dia.
SM87/BETA 87	223 x 51 mm (8.8 x 2 in.), L x Dia.

### Weight

SM58/BETA 58	289 g (10.2 oz.) without batteries
SM86	251 g (8.8 oz.) without batteries
SM87/BETA 87	258 g (9.1 oz.) without batteries

### Power Requirements

9 V alkaline

### RF Output Power

30 mW maximum

varies by region

## Transmitter Input

### Configuration

Unbalanced, active

### Impedance

20 k $\Omega$

### Maximum Input Level

1 kHz at 1% THD

12 dBV (10 Vp-p)

## ULXS4, ULXP4

### Dimensions

ULXS4	43 x 214 x 163 mm (1.72 x 8.56 x 6.52 in.), H x W x D
ULXP4	43 x 214 x 172 mm (1.72 x 8.56 x 6.88 in.), H x W x D

### Weight

ULXS4	1049 g (2 lbs, 5 oz.)
ULXP4	1105 g (2 lbs, 7 oz.)

### Power Requirements

14–18 V DC (negative ground), 550 mA

## Analog Audio Output

### Configuration

XLR Output	Active Balanced
6.35 mm (1/4") output	Unbalanced

### Impedance

XLR Output	MIC setting	1848 $\Omega$
	LINE setting	75 $\Omega$
6.35 mm (1/4") output	3 k $\Omega$	

### Maximum Audio Output Level

Ref.  $\pm 38$  kHz deviation with 1 kHz tone

XLR connector (into 600 $\Omega$ load)	MIC setting	-17 dBV
	LINE setting	+3.9 dBV
6.35 mm (1/4") connector (into 3 k $\Omega$ load)	-2 dBV	

### Pin Assignments

XLR Output	1=ground, 2=hot, 3=cold
6.35 mm (1/4") connector	Tip=audio, Ring/Sleeve=ground

## Receiver Antenna Input

### Connector Type

BNC

### Impedance

50  $\Omega$

### Nominal Input Level

-95 to -30 dBm

### Maximum Input Level

-20 dBm

### DC bias

12 V DC, 150 mA, maximum

## ULX FREQUENCIES FOR EUROPEAN COUNTRIES

ULX-G3E 470 - 506 MHz, max. 30 mW	
Country Code	Frequency Range
Code de Pays	Gamme de frequences
Codice di paese	Gamme di frequenza
Código de país	Gama de frecuencias
Länder-Kürzel	Frequenzbereich
A, B, BG, CH, CY, CZ, D, EST	470 - 506 MHz *
F, GB, GR, H, I, IS, L, LT	470 - 506 MHz *
NL, P, PL, S, SK, SLO	470 - 506 MHz *
DK, FIN, M, N	*
HR, E, IRL, LV, RO, TR	*
all other countries	*

ULX R4 784–820 MHz max. 30 mW	
Country Code:	Frequency Range
Code de Pays:	Gamme de frequences
Codice di paese:	Gamme di frequenza
Código de país:	Gama de frecuencias
Länder-Kürzel:	Frequenzbereich
A, B, CH, D, E, F, GB	784–820 MHz *
GR, I, IRL, L, NL, P	784–820 MHz *
DK, N	800-820 MHz *
FIN	800.1–819.9 MHz *
S	800–814 MHz *
I, GB, All other Countries	*

ULX J2 554–590 MHz max. 30 mW	
Country Code:	Frequency Range
Code de Pays:	Gamme de frequences
Codice di paese:	Gamme di frequenza
Código de país:	Gama de frecuencias
Länder-Kürzel:	Frequenzbereich
A, B, CH, D, E, F, GB	554–590 MHz *
GR, I, IRL, L, NL, P	554–590 MHz *
DK, FIN, N, S	*
All other Countries	*

ULX S3 829–865 MHz max. 10 mW	
Country Code:	Frequency Range
Code de Pays:	Gamme de frequences
Codice di paese:	Gamme di frequenza
Código de país:	Gama de frecuencias
Länder-Kürzel:	Frequenzbereich
A, B, CH, D, E	829–865 MHz *
GR, IRL, L, NL, P	838–862 MHz *
GB	830-865 MHz*
DK, F, FIN, I, N, S	863–865 MHz*
All other Countries	*

ULX-K2E 606 - 642 MHz, max. 10 mW	
Country Code	Frequency Range
Code de Pays	Gamme de frequences
Codice di paese	Gamme di frequenza
Código de país	Gama de frecuencias
Länder-Kürzel	Frequenzbereich
A, BG, CH, CY, CZ, D, EST	606 - 642 MHz *
F, GB, GR, H, I, IS, L, LT	606 - 642 MHz *
P, PL, S, SK, SLO	606 - 642 MHz *
B, DK, FIN, M, N, NL	*
HR, E, IRL, LV, RO, TR	*
all other countries	*

ULX Q2 748–784 MHz max. 30 mW	
Country Code:	Frequency Range
Code de Pays:	Gamme de frequences
Codice di paese:	Gamme di frequenza
Código de país:	Gama de frecuencias
Länder-Kürzel:	Frequenzbereich
A, B, CH, D, E, F, GB	748–784 MHz *
GR, I, IRL, L, NL, P	748–784 MHz *
DK, FIN, N, S	*
All other Countries	*

ULX M2 662–698 MHz max. 30 mW	
Country Code:	Frequency Range
Code de Pays:	Gamme de frequences
Codice di paese:	Gamme di frequenza
Código de país:	Gama de frecuencias
Länder-Kürzel:	Frequenzbereich
A, B, CH, D, E, F, GB	662–698 MHz *
GR, I, IRL, L, NL, P	662–698 MHz *
DK, FIN, N, S	*
All other Countries	*

## ULX SYSTEM COMPATIBILITY GUIDE FOR FREQUENCY BAND G3E (470–506 MHz)

Channel	Group 1	Group 2	Group 3	Group 4	Group 5	Group 6	Group 7
	Full Range max. # of compatible frequencies (option 1)	Full Range max. # of compatible frequencies (option 2)	Full Range max. # of compatible frequencies (option 3)	France preferred: User Group A (option 1)	France preferred: User Group A (option 2)	France preferred: User Group A (option 3)	France preferred: User Group B (option 1)
1	470.775	470.250	470.450	470.750	471.500	470.750	472.025
2	471.525	471.950	473.575	471.500	472.500	471.750	472.775
3	473.350	473.300	474.125	472.500	473.750	472.500	474.225
4	474.875	474.175	475.150	473.250	474.500	474.500	474.975
5	476.150	475.700	476.450	473.750	475.500	475.750	476.900
6	476.850	476.875	476.975	474.500	476.250	476.250	477.700
7	477.775	478.875	479.025	475.500	480.500	478.750	480.025
8	480.000	479.950	480.725	479.750	481.250	479.250	480.775
9	481.250	481.525	482.150	483.250	481.750	480.500	486.100
10	481.900	482.300	483.275	484.250	483.250	482.500	490.225
11	483.400	483.925	484.175	487.250	483.750	483.250	490.975
12	484.300	485.025	485.600	487.750	486.750	483.750	492.900
13	488.250	486.850	488.575	489.250	487.750	487.500	493.700
14	490.175	491.925	489.875	489.750	489.250	489.750	496.775
15	491.500	492.425	493.425	490.500	490.500	491.500	498.225
16	494.250	494.000	494.450	491.500	491.500	495.250	498.975
17	495.025	495.125	495.250	495.500	495.750	496.500	500.900
18	495.550	497.225	496.725	496.500	496.500	497.250	501.700
19	497.600	498.575	497.300	497.250	498.500	498.500	504.025
20	499.350	500.175	499.650	498.500	499.500	499.500	504.775
21	500.575	500.700	501.675	499.250	500.250	502.750	
22	501.325	503.675	502.325	500.250	502.750	503.500	
23	502.300	504.400	504.275	502.750	503.500	504.500	
24	504.725	505.450	505.300	504.500	505.750	505.250	

Channel	Group 8	Group 9	Group 10	Group 11	Group 12	Group 13	Group 14	Group 15	Group 16
	France preferred: User Group B (option 2)	France preferred: User Group B (option 3)	France preferred: User Group C (option 1)	France preferred: User Group C (option 2)	France preferred: User Group C (option 3)	European TV channel 21 optimized 470 - 478 MHz	European TV channel 22 optimized 478 - 486 MHz	European TV channel 23 optimized 486 - 494 MHz	European TV channel 24 optimized 494 - 502 MHz
1	470.500	472.025	470.300	470.300	470.300	470.300	478.300	486.300	494.300
2	472.025	473.500	471.000	471.000	471.000	471.025	479.025	487.025	495.025
3	472.775	477.300	472.225	474.025	472.225	471.525	479.525	487.525	495.525
4	474.225	478.100	474.775	474.775	474.775	472.275	480.275	488.275	496.275
5	477.300	480.025	476.000	476.000	476.000	473.275	481.275	489.275	497.275
6	478.500	480.775	476.700	476.700	476.700	473.875	481.875	489.875	497.875
7	480.025	482.225	478.300	478.300	478.300	474.775	482.775	490.775	498.775
8	480.775	482.975	479.000	479.000	479.000	475.250	483.250	491.250	499.250
9	482.225	484.900	480.225	480.225	480.225	475.975	483.975	491.975	499.975
10	485.300	485.700	482.775	484.700	484.000	476.950	484.950	492.950	500.950
11	492.900	490.225	484.000	490.775	484.700	477.675	485.675	493.675	501.675
12	493.700	492.900	492.700	492.000	490.775				
13	496.775	493.700	494.300	494.300	494.300				
14	498.225	496.025	495.000	495.000	495.000				
15	498.975	496.775	496.225	496.225	496.225				
16	500.900	501.300	498.775	498.775	498.775				
17	502.500	502.100	500.000	500.000	500.000				
18	504.775	504.025	500.700	500.700	500.700				
18	505.500	505.500	502.300	502.300	502.300				
20			503.000	503.000	503.000				
21			504.225	504.225	504.225				

## ULX SYSTEM COMPATIBILITY GUIDE FOR FREQUENCY BAND K2E (606-642 MHz)

Channel	Group 1	Group 2	Group 3	Group 4	Group 5	Group 6	Group 7	Group 8	Group 9
	Full Range max. # of compatible frequencies (option 1)	Full Range max. # of compatible frequencies (option 2)	Full Range max. # of compatible frequencies (option 3)	Full Range max. # of compatible frequencies, Ch. 38 excluded (option 1)	Full Range max. # of compatible frequencies, Ch. 38 excluded (option 2)	Full Range max. # of compatible frequencies, Ch. 38 excluded (option 3)	U.K. preferred: TV ch. 38 606-614 MHz with 500 kHz guard band (option 1)	U.K. preferred: TV ch. 38 606-614 MHz with 500 kHz guard band (option 2)	U.K. preferred: TV ch. 38 606-614 MHz with 500 kHz guard band (option 3)
1	606.450	606.800	606.150	614.200	614.125	614.225	606.775	606.650	606.500
2	607.250	608.300	607.350	614.950	615.200	615.175	607.300	607.625	607.150
3	608.725	608.925	607.825	615.450	615.925	615.875	608.325	608.375	608.025
4	609.900	610.375	608.775	616.950	617.125	616.350	609.100	608.850	608.525
5	611.325	611.525	612.875	617.575	618.050	617.275	609.600	609.725	609.300
6	611.825	612.175	613.350	619.925	619.875	618.950	610.500	610.350	610.325
7	613.075	613.450	615.300	620.675	620.425	620.100	611.125	611.325	610.975
8	615.150	614.400	616.150	621.175	621.375	621.025	612.175	612.075	611.875
9	615.725	615.000	616.700	623.375	623.500	622.475	612.925	612.575	612.350
10	616.950	615.825	617.475	624.125	626.125	623.375	613.450	613.400	613.075
11	617.875	616.900	620.275	628.950	628.125	625.325			
12	619.350	619.150	621.375	630.400	629.425	631.275			
13	621.200	628.325	624.175	632.175	630.350	632.275			
14	626.425	628.875	628.550	633.025	631.500	632.775			
15	628.100	630.525	629.125	633.525	633.875	633.950			
16	631.900	631.125	630.500	635.150	635.600	634.550			
17	632.750	635.400	633.700	636.150	636.600	635.950			
18	634.300	636.375	634.700	637.725	637.900	637.600			
19	635.425	636.850	636.325	638.550	638.750	638.325			
20	636.250	637.800	637.625	639.025	639.925	639.850			
21	638.625	638.975	638.525	640.575	640.550	640.950			
22	639.525	639.450	639.175	641.650	641.400	641.750			
23	640.150	640.575	640.050						
24	641.300	641.325	641.250						

Channel	Group 10	Group 11	Group 12	Group 13	Group 14	Group 15	Group 16	Group 17	Group 18
	France preferred: User Group A (option 1) 614 - 642 MHz	France preferred: User Group A (option 2) 614 - 642 MHz	France preferred: User Group B (option 1) 614 - 642 MHz	France preferred: User Group B (option 2) 614 - 642 MHz	France preferred: User Group C (option 1) 614 - 642 MHz	France preferred: User Group C (option 1) 614 - 642 MHz	European TV channel 39 optimized 614 - 622 MHz	European TV channel 40 optimized 622 - 630 MHz	European TV channel 41 optimized 630 - 638 MHz
1	614.750	614.750	614.500	616.025	614.300	640.975	614.200	622.200	630.200
2	615.500	615.250	616.025	616.775	615.000	640.225	614.700	622.700	630.700
3	616.500	616.500	616.775	618.225	616.225	637.900	615.750	623.750	631.750
4	617.250	617.250	618.225	620.900	618.775	637.100	616.500	624.500	632.500
5	617.750	618.500	620.900	621.700	620.000	636.000	617.025	625.025	633.025
6	618.500	619.500	621.700	624.025	621.900	632.975	617.900	625.900	633.900
7	619.500	620.250	624.025	624.775	623.000	632.225	618.550	626.550	634.550
8	622.750	622.750	624.775	628.900	626.775	630.300	619.575	627.575	635.575
9	623.750	623.500	629.300	630.500	629.100	629.100	620.375	628.375	636.375
10	625.750	626.500	630.500	634.225	630.300	626.775	620.875	628.875	636.875
11	627.500	627.250	634.225	634.975	632.225	623.000	621.850	629.850	637.850
12	631.500	627.750	636.500	636.500	632.975	621.900			
13	632.500	631.500	637.300	637.300	636.000	620.000			
14	633.250	632.500	638.500	638.500	637.100	618.775			
15	634.500	633.250	640.775	640.775	637.900	616.225			
16	635.250	633.750	641.500	641.500	640.225	615.000			
17	636.250	635.500			640.975	614.300			
18	638.750	636.250							
19	639.750	640.500							
20	640.500	641.250							
21	641.750	641.750							

## ULX SYSTEM COMPATIBILITY GUIDE FOR FREQUENCY BAND X3 (925-932 MHz)

Channel	Group 1	Group 2	Group 3	Group 4	Group 5	Group 6	Group 7	Group 8	Group 9
	Full range, Robust, 7 channels	Full range, Robust, 7 channels	Full range, Robust, 7 channels	Full range, Standard, 8 channels	Full range, Standard, 8 channels	Full range, Standard, 8 channels	Full range, Max frequencies, 9 channels	Full range, Max frequencies, 9 channels	Full range, Max frequencies, 9 channels
1	925.175	925.150	925.775	925.325	925.450	925.225	925.125	925.275	925.150
2	926.325	926.200	926.475	926.125	926.000	926.275	925.850	926.275	926.050
3	926.925	927.700	927.550	926.600	927.050	926.950	926.300	926.975	926.625
4	927.900	928.625	928.125	927.350	927.825	927.950	927.075	927.925	927.475
5	929.750	929.875	930.125	929.700	929.025	928.400	928.600	928.425	928.650
6	930.225	930.575	931.025	930.325	929.925	929.250	929.300	929.250	929.375
7	931.100	931.725	931.500	931.225	930.525	931.250	929.725	930.325	930.400
8				931.775	931.650	931.850	930.400	930.900	930.925
9							931.775	931.850	931.700

## ULX SYSTEM COMPATIBILITY GUIDE FOR FREQUENCY BAND X7 (925 - 937.5 MHz)

CHANNEL	Group 1	Group 2	Group 3	Group 4	Group 5	Group 6	Group 7	Group 8	Group 9
	more freqs.	more freqs.	more freqs.	more freqs.	more freqs.	more freqs.	more freqs.	more freqs.	more freqs.
1	925.175	925.150	925.775	925.325	925.450	925.225	925.125	925.275	925.150
2	926.325	926.200	926.475	926.125	926.000	926.275	925.850	926.275	926.050
3	926.925	927.700	927.550	926.600	927.050	926.950	926.300	926.975	926.625
4	927.900	928.625	928.125	927.350	927.825	927.950	927.075	927.925	927.475
5	929.750	929.875	930.125	929.700	929.025	928.400	928.600	928.425	928.650
6	930.225	930.575	931.025	930.325	929.925	929.250	929.300	929.250	929.375
7	931.100	931.725	931.500	931.225	930.525	931.250	929.725	930.325	930.400
8	<b>932.825</b>	<b>933.200</b>	<b>932.375</b>	931.775	931.650	931.850	930.400	930.900	930.925
9	<b>934.875</b>	<b>933.825</b>	<b>935.150</b>	<b>934.825</b>	<b>934.800</b>	<b>933.525</b>	931.775	931.850	931.700
10	<b>936.250</b>	<b>935.450</b>	<b>935.875</b>	<b>935.600</b>	<b>935.925</b>	<b>934.800</b>	<b>935.325</b>	<b>934.125</b>	<b>936.200</b>
11	<b>936.675</b>	<b>936.250</b>	<b>936.900</b>	<b>936.625</b>	<b>936.675</b>	<b>936.475</b>	<b>935.925</b>	<b>936.150</b>	<b>937.100</b>
12	<b>937.350</b>	<b>936.800</b>				<b>937.025</b>	<b>936.875</b>	<b>937.100</b>	

## PERU DECLARATION OF CONFORMITY

Shure Incorporated  
5800 W. Touhy Avenue  
Niles, Illinois 60714-4608, U.S.A.  
(847) 600-2000

Shure Incorporated declares that the following product

**Model:** ULX1-J2 (554-590MHz) ULX1-M2 (662-698MHz)

**Description:** UHF FM Wireless Microphone Transmitter

Has been tested and found to comply with the limits set in Peru wireless regulatory standard **RM N ° 204-2009-MTC/03**. It's effective radiated power (ERP) has been measured to be less than 10 mW, as measured in accordance with ETSI standard EN 300 422.

**Signed**  **Date:** August 24, 2009  
**Name, Title:** Kevin Marrs, Manager, Global Compliance, Shure Incorporated

## PERU DECLARATION OF CONFORMITY

Shure Incorporated  
5800 W. Touhy Avenue  
Niles, Illinois 60714-4608, U.S.A.  
(847) 600-2000

Shure Incorporated declares that the following product

**Model:** ULX2-J2 (554-590MHz) ULX2-M2 (662-698MHz)

**Description:** UHF FM Wireless Microphone Transmitter

Has been tested and found to comply with the limits set in Peru wireless regulatory standard **RM N ° 204-2009-MTC/03**. It's effective radiated power (ERP) has been measured to be less than 10 mW, as measured in accordance with ETSI standard EN 300 422.

**Signed**  **Date:** August 24, 2009  
**Name, Title:** Kevin Marrs, Manager, Global Compliance, Shure Incorporated

**SHURE**<sup>®</sup>  
LEGENDARY  
PERFORMANCE™

©2014 Shure Incorporated

United States, Canada,  
Latin America, Caribbean:  
Shure Incorporated  
5800 West Touhy Avenue  
Niles, IL 60714-4608 USA

Phone: +1 847-600-2000  
Fax: +1 847-600-1212 (USA)  
Fax: +1 847-600-6446  
Email: [info@shure.com](mailto:info@shure.com)  
[www.shure.com](http://www.shure.com)

Europe, Middle East, Africa:  
Shure Europe GmbH  
Jakob-Dieffenbacher-Str. 12,  
75031 Eppingen, Germany

Phone: +49-7262-92490  
Fax: +49-7262-9249114  
Email: [info@shure.de](mailto:info@shure.de)  
[www.shure.eu](http://www.shure.eu)

Asia, Pacific:  
Shure Asia Limited  
22/F, 625 King's Road  
North Point, Island East  
Hong Kong

Phone: +852-2893-4290  
Fax: +852-2893-4055  
Email: [info@shure.com.hk](mailto:info@shure.com.hk)  
[www.shureasia.com](http://www.shureasia.com)