



Model WH20 User Guide

MODEL WH20 DYNAMIC HEADSET MICROPHONE



GENERAL

The Shure Model WH20 is a rugged, light-weight, dynamic headset microphone that provides high-quality voice pickup. It fits securely for active microphone users, such as aerobics instructors and musicians, with low visibility for stage appearances. The WH20 is suitable for any voice communications application where comfort and reliability are required.

The WH20 has a cardioid (unidirectional) pickup pattern. This provides greater gain-before-feedback and isolation from ambient noise and other unwanted sound sources, such as air-conditioning, musical instruments and loudspeakers. A carefully shaped frequency response includes a voice-frequency presence peak and a low-frequency rolloff to compensate for the proximity effect inherent in cardioid microphones during close-talk operation.

An integrated elastic headband secures the headset comfortably. The headband, wireframe, and gooseneck are adjustable to accommodate any head size or shape. The WH20 is supplied with a foam windscreen and clothing clip.

FEATURES

- Lightweight wireframe and headband adjust for a secure, comfortable fit
- Extra-strong, small-diameter attached microphone cable resists breakage
- Collapsible microphone boom for easy storage and transportation
- Smooth, natural frequency response comparable to high-quality dynamic hand-held vocal microphones
- High input clipping level eliminates overload distortion
- Reliable at temperature and humidity extremes
- Supplied foam windscreen and clothing clip

MODEL VARIATIONS

- The *WH20QTR* has a right-angle 1/4-inch phone plug for use with Shure Headset Wireless Microphone Systems, or any unbalanced microphone input.
- The *WH20TQG* has a miniature four-pin female connector for direct connection to Shure wireless body pack transmitters.
- The *WH20XLR* has a three-pin male XLR connector with a convenient detachable belt clip.

MICROPHONE PARTS

The WH20 consists of the following parts:

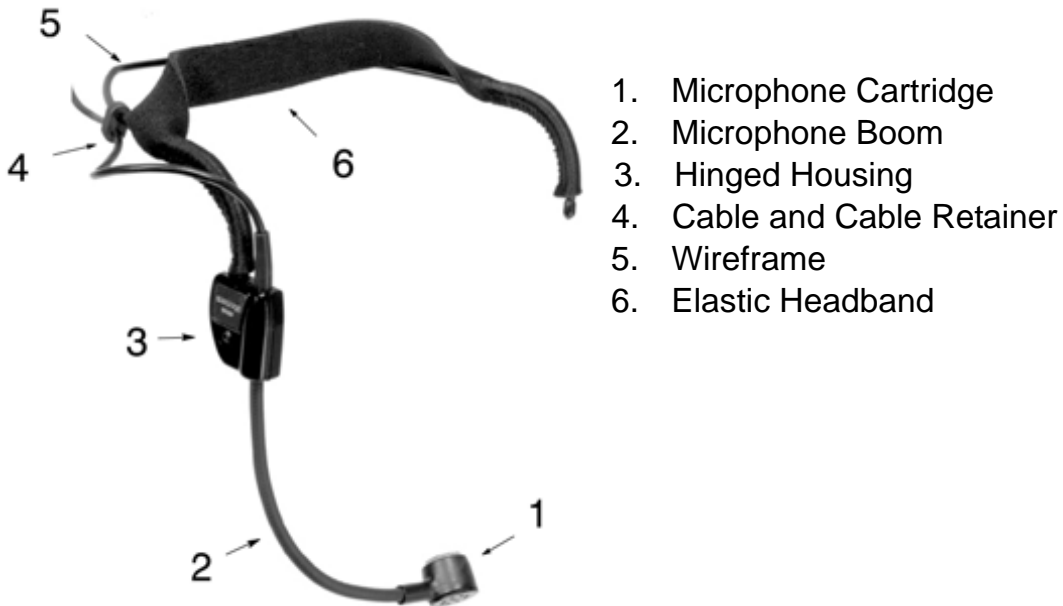

MICROPHONE PARTS
FIGURE 1

COLLAPSIBLE MICROPHONE BOOM

The WH20 headset features a collapsible boom for shipment and storage. **Before wearing the headset**, unfold the boom until it snaps and locks into place. Refold for storage or transportation.

WEARING THE HEADSET

Place the headset wireframe around the head so that the wireframe and elastic band are **horizontal across the back of the head** and the ends of the wireframe fit over and in front of the ears. Position the elastic headband either above or below the wireframe to provide the greatest comfort and stability. The white "SHURE" should face outward.



WEARING THE HEADSET
FIGURE 2

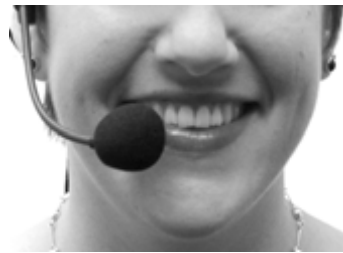
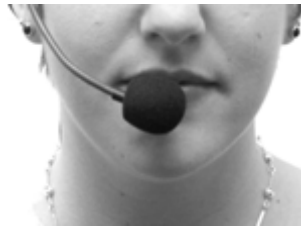

POSITIONING THE MICROPHONE
FIGURE 3

ADJUSTING THE HEADSET

- If the headset feels loose or uncomfortable, carefully bend the sides of the wireframe to make it tighter or looser (Figure 4A). The angle of the wireframe earpieces may also need adjustment (Figure 4B).
- Adjust the tension of the elastic headband across the back of the head by sliding it up or down the ends of the wireframe (see Figure 5).

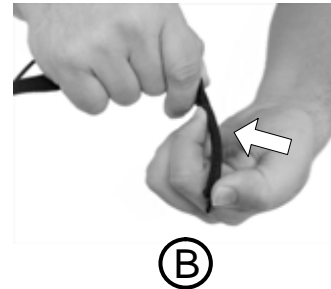
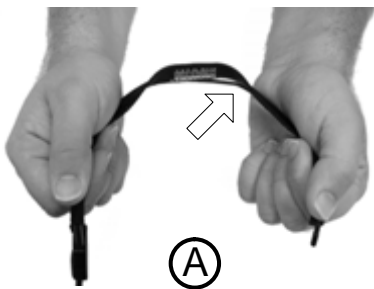

ADJUSTING THE WIREFRAME
FIGURE 4

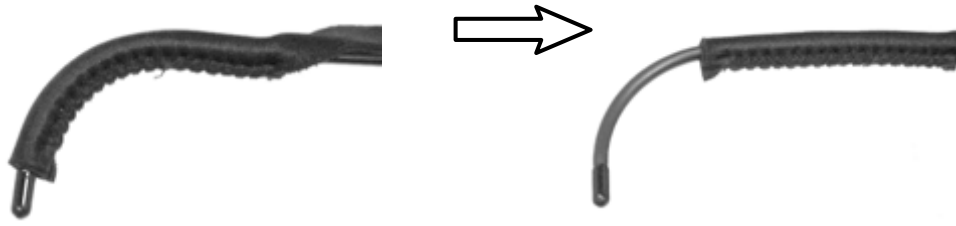

ELASTIC HEADBAND ADJUSTMENT
FIGURE 5

POSITIONING THE MICROPHONE

IMPORTANT: For maximum gain before feedback, position the gooseneck so that the microphone grille (silver side) is within 25 mm (1 inch) of the *right corner* of the mouth. Do NOT position it directly in front of the mouth (see Figure 3).

USING THE CLOTHING CLIP

The supplied spring-loaded clothing clip secures the microphone cable to the user's clothing and keeps it from becoming entangled with the user's movements.

OPERATION

Connect the WH20 to the microphone input of a wireless microphone transmitter or a balanced wired microphone input.

NOTE: The WH20 is a dynamic microphone and has inherently lower output than condenser microphones. The transmitter gain may need to be increased to compensate for the WH20's lower output.

WINDSCREEN

If breath noise or "popping" is audible over the sound system, install the supplied windscreen.

WASHING THE FOAM WINDSCREEN

The foam windscreen protects the WH20's microphone-element from dirt and moisture. When necessary, it can be removed and cleaned in a mild soapy water solution.

IMPORTANT: Never clean the windscreen with any liquid solution without first removing the windscreen from the microphone boom.

1. Gently pull the windscreen away from microphone.
2. Immerse the windscreen in mild soapy water and gently squeeze it several times.
3. Rinse the windscreen in clean water and dry it with a clean cloth or paper towel. Allow it to air-dry thoroughly.
4. When the windscreen is dry, slide it over the WH20 microphone.

WASHING THE ELASTIC HEADBAND

The elastic headband can be removed from the wireframe and hand-washed in a mild soapy water solution. To remove and wash the headband, follow these steps:

1. Remove the microphone cable retainer from the wireframe.
2. Slide the elastic headband off the wireframe.
3. Wash the headband and allow to dry thoroughly.
4. Slide the headband around the wireframe to its original position. Reattach the cable with the plastic retainer.

Note that the elastic headband supplied with the WH20 is *not* a standard size; headbands purchased in stores are too long for this application.

SPECIFICATIONS

Type

Dynamic, Close-Talking

Frequency Response (at 8 mm)

50 to 15,000 Hz

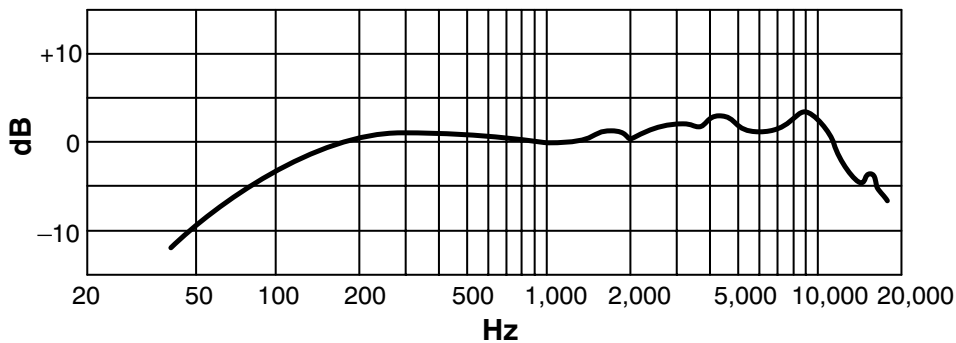

TYPICAL FREQUENCY RESPONSE
FIGURE 6

Polar Pattern

Cardioid (unidirectional) response-uniform with frequency, symmetrical about axis

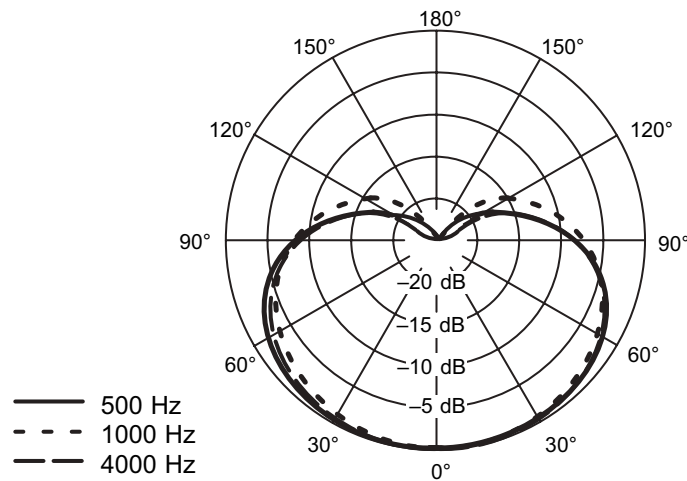

TYPICAL POLAR PATTERNS
FIGURE 7

Impedance

Rated at 150 ohms (200 ohms actual)

Output Level (close talked* at 1,000 Hz)

Open Circuit Voltage: -67.0 db/Pa (0.45 m)

..... 1Pa = 94 dB SPL

*At 12.5 mm (1/2 inch)

Hum Sensitivity

38.4 dB equivalent SPL in a 1 millioersted field

Polarity

WH20QTR as a wired microphone: Positive sound pressure on diaphragm produces positive voltage on tip with respect to sleeve (ground) of microphone output phone plug connector.

WH20QTR, WH20TQG used with Shure Wireless Systems:

1/4-inch Phone Jack Receiver Outputs: Positive sound pressure on diaphragm produces positive voltage on tip of receiver output connector.

3-pin XLR Receiver Outputs: Positive sound pressure on diaphragm produces positive voltage on pin 2 with respect to pin 3 of low-impedance output connector, and on tip of Aux output connector.

WH20XLR as a wired microphone: Positive sound pressure on diaphragm produces positive voltage on pin 2 with respect to pin 3 of microphone output XLR connector.

Environmental Conditions

Operating Temperatures: -18° to 60° C (0° to 140°F)

Storage Temperatures: -29° to 74°C (-20° to 165°F)

Humidity: 0 to 95%

Cable

Attached 1.22 m (4 ft), small-diameter, shielded, PVC-jacketed, two-conductor.

Cable Connector

WH20QTR: Right-angle 1/4-inch phone plug

WH20TQG: Female 4 pin mini connector (TA4F)

WH20XLR: Three-pin XLR with detachable belt clip

Construction

Black thermoplastic housing; stainless steel grille; black TEFLON®-coated stainless steel wire-frame; flexible plastic-clad monel gooseneck; rubber/nylon elastic headband

Net Weight (including connector)

WH20: 63 g (2.2 oz)

WH20TQG: 63 g (2.2 oz)

WH20XLR: 98 g (3.5 oz)

CERTIFICATION

Eligible to bear CE Marking. Conforms to European EMC Directive 89/336/EEC. Meets applicable tests and performance criteria in European Standard EN55103 (1996) parts 1 and 2, for residential (E1) and light industrial (E2) environments.

REPLACEMENT PARTS

Cable Connector (for WH20TQG only)	WA330
Connector Belt Clip (for WH20XLR only)	RK200BC
Black Elastic Headband	RK319
Black Elastic Headband and Wireframe	RPM600
Microphone, Cable and Connector Assembly:	
1/4-inch (WH20QTR only)	RPM100
Mini, four pin connector (WH20TQG only)	RPM102
XLR (WH20XLR only)	RPM104
Black Windscreens (2) and Clothing Clip	RK318WS

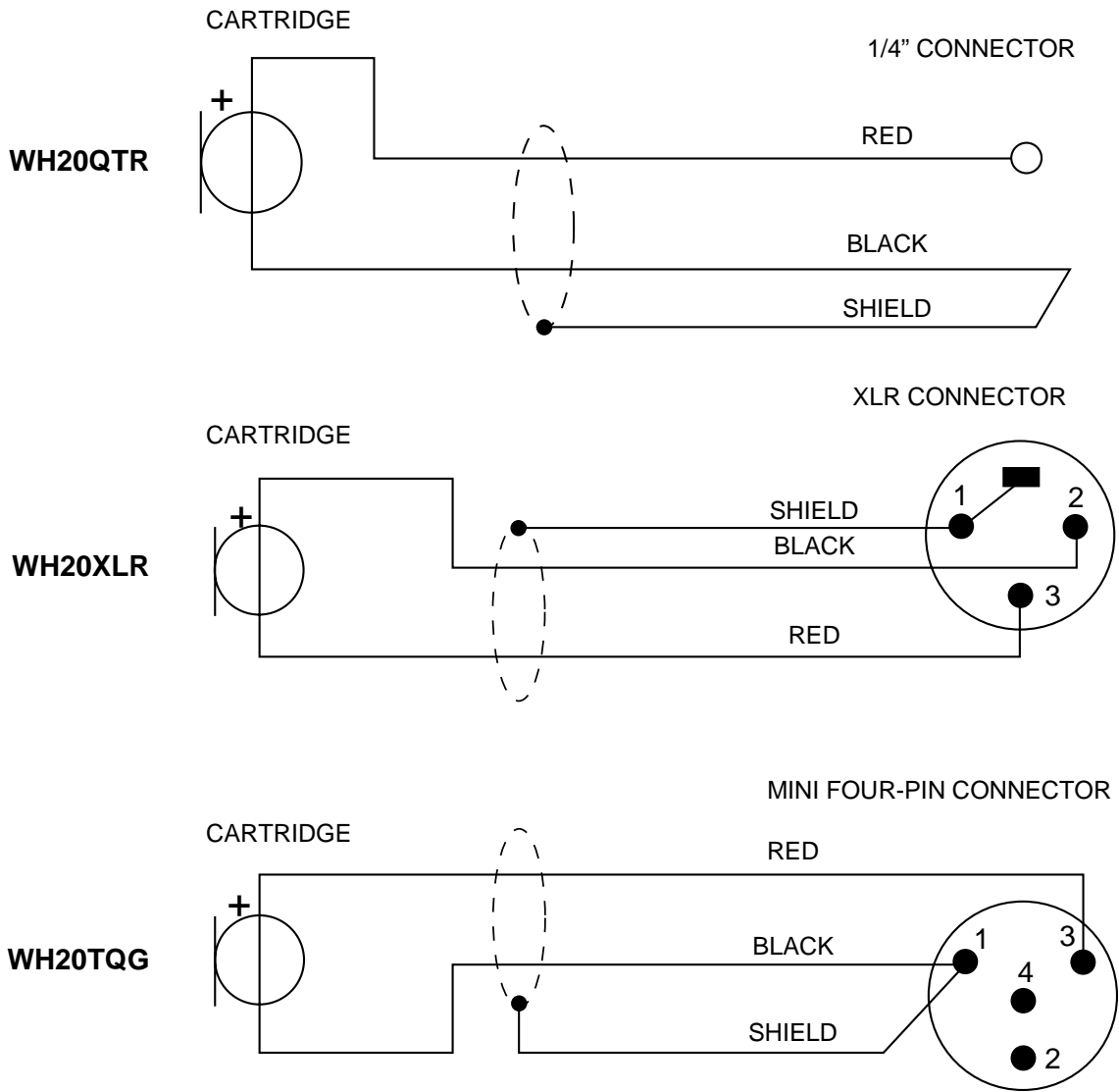

WIRING DIAGRAMS
FIGURE 8



SHURE Incorporated <http://www.shure.com>
United States, Canada, Latin America, Caribbean:
5800 W. Touhy Avenue, Niles, IL 60714-4608, U.S.A.
Phone: 847-600-2000 U.S. Fax: 847-600-1212 Int'l Fax: 847-600-6446
Europe, Middle East, Africa:
Shure Europe GmbH, Phone: 49-7131-72140 Fax: 49-7131-721414
Asia, Pacific:
Shure Asia Limited, Phone: 852-2893-4290 Fax: 852-2893-4055