

Install Speakers

VX 12Q

12" PowerDual Full Range Loudspeaker with Q-Centric Waveguide for Portable and Installation Applications

- Full range multi-purpose sound reinforcement loudspeaker for portable and installation applications
- 350 Watts continuous, 1,400 Watts peak power
- 12" PowerDual full range driver for point source phase coherence
- Q-Centric waveguide for tighter vertical or horizontal pattern control
- Precise 75° H x 40° V dispersion for optimum coverage and forward projection
- Ideal for FOH, floor monitor and side fill applications
- Configurable for bi-amp operation
- Vented and internally braced plywood enclosure
- Finished with hard wearing semi matt black paint
- Rugged powder coated perforated steel mesh grille
- Blanking plate for optional VTH pole mount
- Optional horizontal and vertical mounting yokes (available separately)
- Integrip handles ergonomically integrated into top and bottom of cabinet
- Neutrik speakON* NL4 and barrier strip connectors for input and link output
- 5-Year Warranty Program*
- Designed and engineered in the U.K.



The VX 12Q is a new class of device that delivers high SPL, low distortion audio coverage in a complete high performance loudspeaker cabinet. It provides a high impact solution for medium-to-large scale sound reinforcement in high-SPL applications such as bars and clubs, as well as being well suited for mid-scale portable/live PA applications. Thanks to its twin driver design for extended low frequency reproduction and flexible mounting options, the VX 12Q is also ideally suited for use complimenting much larger systems, making it an excellent choice for both installed and portable applications. The VX 12Q can also be configured for bi-amp operation.



PowerDual Driver

The 1,400-Watt 305 mm (12") version of TANNOY's VX Series exclusive point source loudspeakers, VX 12Q's PowerDual driver ensures high power output with high sensitivity and exceptional efficiency. A proprietary Q-Centric waveguide is provided for tighter pattern control, delivering precise 75° horizontal x 40° vertical dispersion for optimum coverage, exceptional forward gain.

Install Speakers

VX 12Q

12" PowerDual Full Range Loudspeaker
with Q-Centric Waveguide for Portable and
Installation Applications

Performance Applications

VX 12Q's trapezoidal enclosure design provides a multitude of placement options including: installed performance sound reinforcement, FOH, floor monitor, high SPL delay, and more. A blanking plate for optional VTH pole mounting is provided for placement atop a subwoofer in portable PA applications. Mounting options include horizontal and vertical mounting yokes (available separately), and 8 M10 Flying inserts. All hardware has been tested and certified for a greater than 5:1 safety ratio – giving installers complete peace of mind.



Construction

Finished in a hard wearing semi matt black paint, the vented and internally braced cabinet is constructed from 15 mm ($\frac{5}{8}$ ") plywood – and includes a rugged powder coated perforated steel mesh grille. Integrip handles ergonomically integrated into the top and bottom of cabinet make for easy transport. The rear panel connector plate carries Neutrik speakON* NL4 and barrier strip connectors for input and link connections to additional enclosures. VX 12Q loudspeakers are optimized for use with [LAB GRUPPEN](#) amplifiers, or [LAKE LM Series](#) controllers. A full range of DSP settings to suit many configurations are provided for free download at tannoy.com.

You Are Covered

We always strive to provide the best possible Customer Experience. Our products are made in our own [MUSIC Group](#) factory using state-of-the-art automation, enhanced production workflows and quality assurance labs with the most sophisticated test equipment available in the world. As a result, we have one of the lowest product failure rates in the industry, and we confidently back it up with a generous 5-Year Warranty program.



Install Speakers

VX 12Q

12" PowerDual Full Range Loudspeaker
with Q-Centric Waveguide for Portable and
Installation Applications

Frequency Response Sensitivity 1 W / 1 m

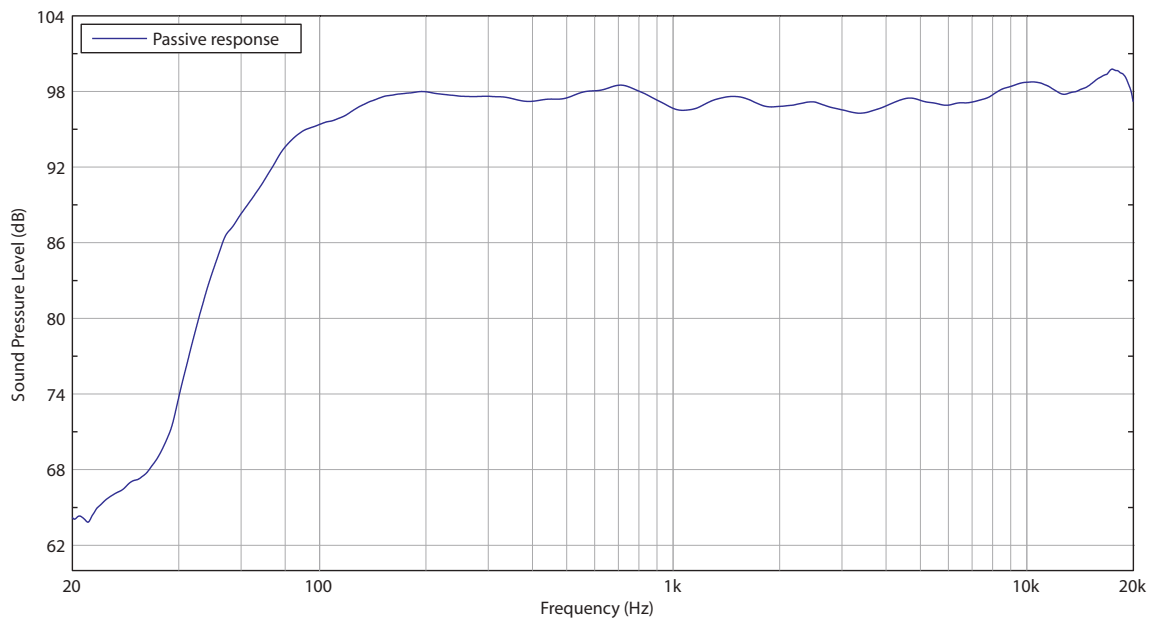

Impedance

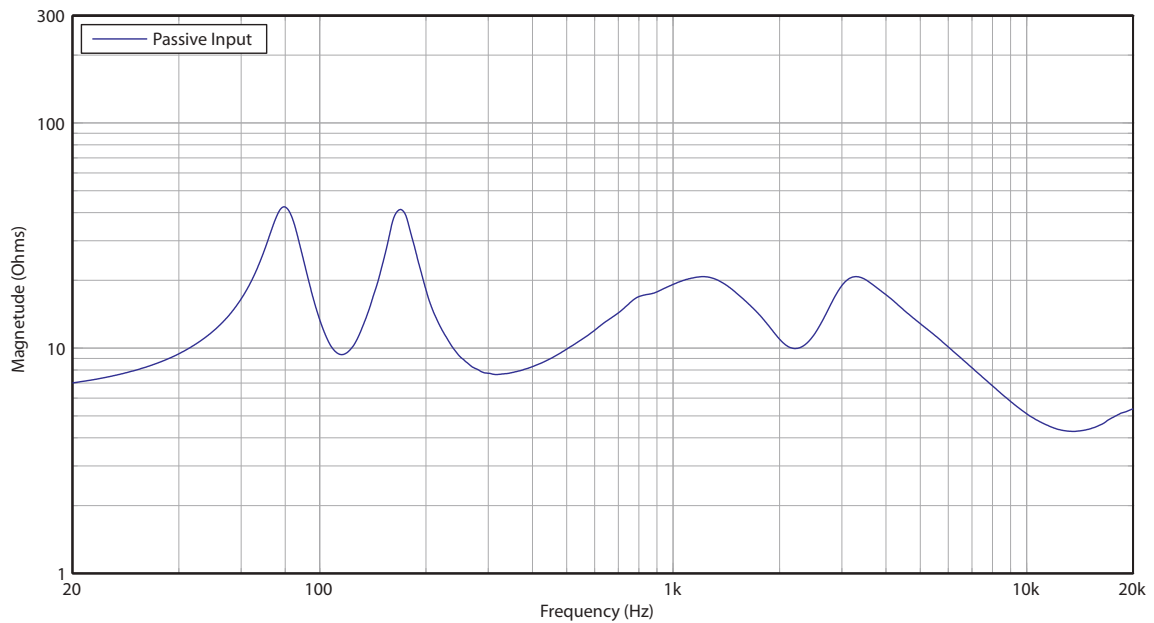

Install Speakers

VX 12Q

12" PowerDual Full Range Loudspeaker
with Q-Centric Waveguide for Portable and
Installation Applications

Horizontal Beamwidth

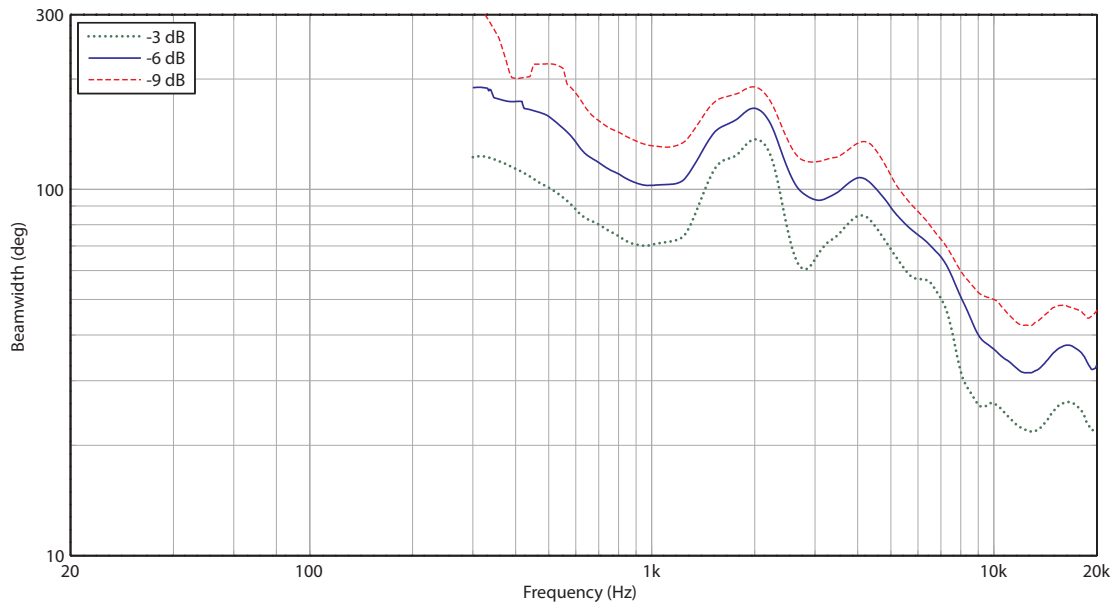

Vertical Beamwidth

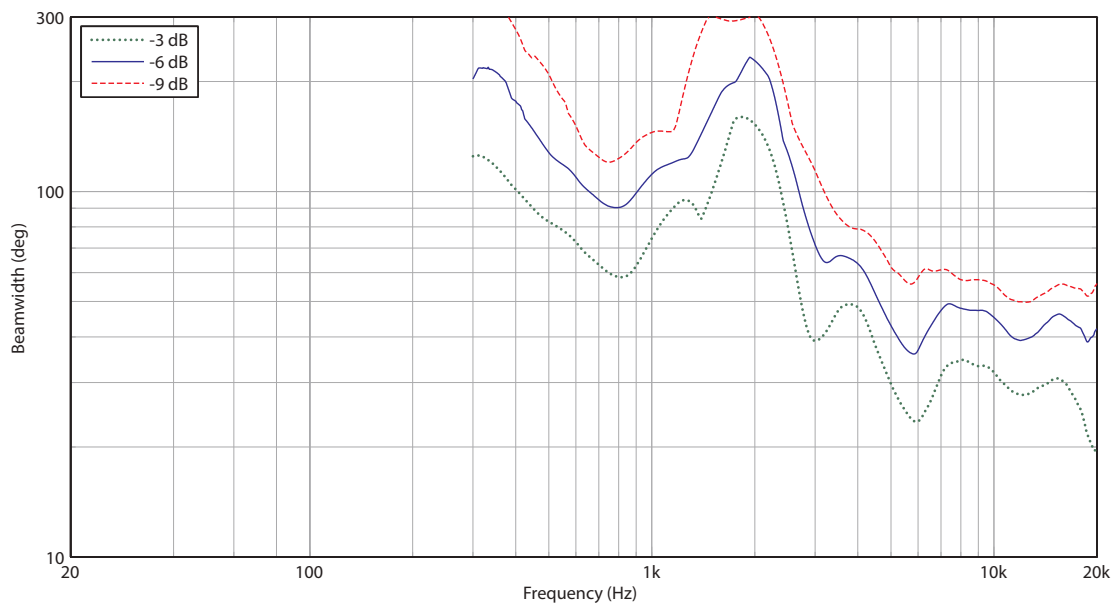

Install Speakers

VX 12Q

12" PowerDual Full Range Loudspeaker
with Q-Centric Waveguide for Portable and
Installation Applications

Horizontal Polar Plots

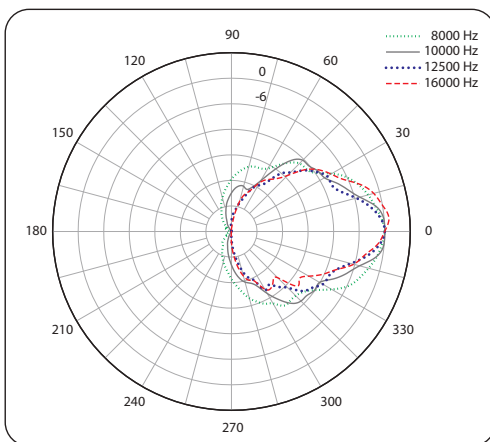
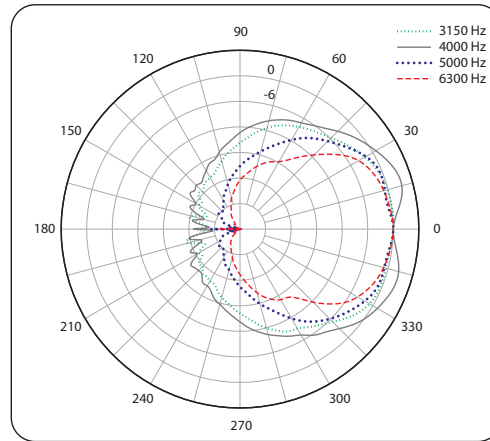
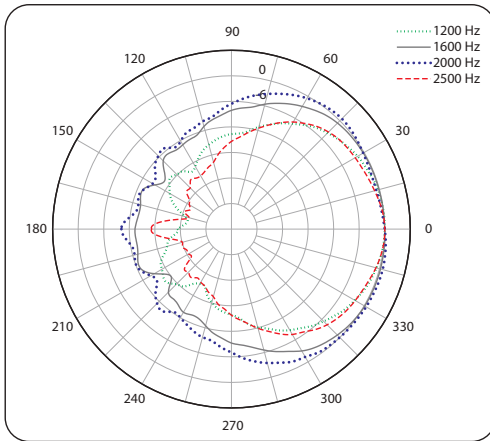
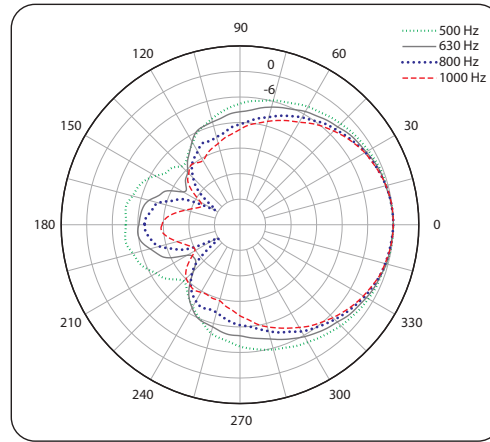
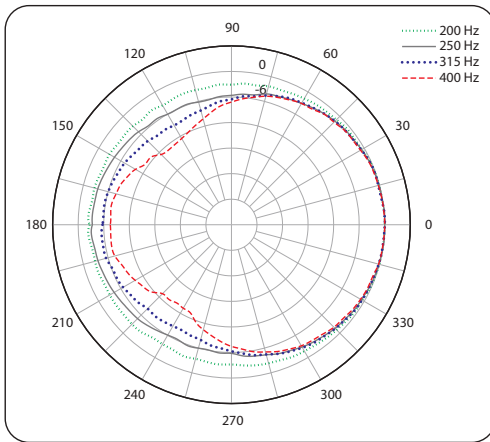

Install Speakers

VX 12Q

12" PowerDual Full Range Loudspeaker
with Q-Centric Waveguide for Portable and
Installation Applications

Vertical Polar Plots

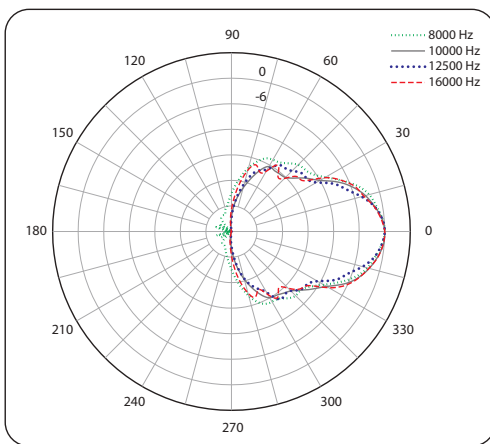
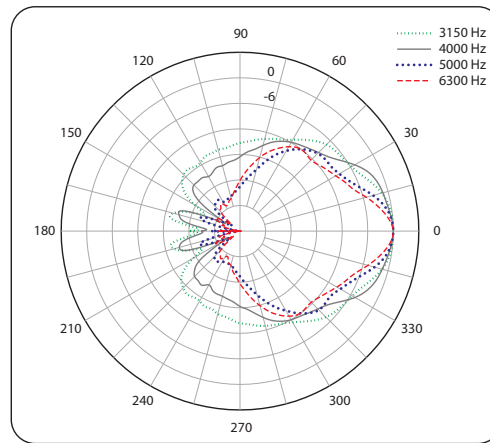
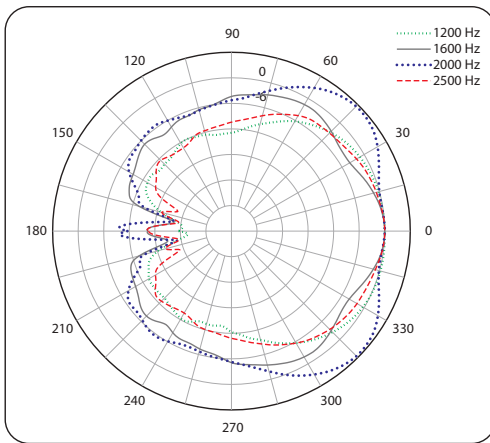
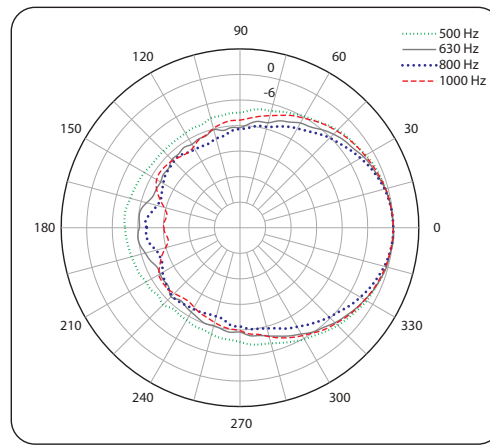
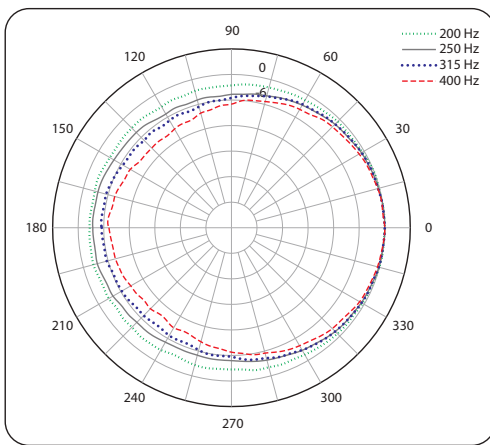

Install Speakers

VX 12Q

12" PowerDual Full Range Loudspeaker
with Q-Centric Waveguide for Portable and
Installation Applications

Dimensions

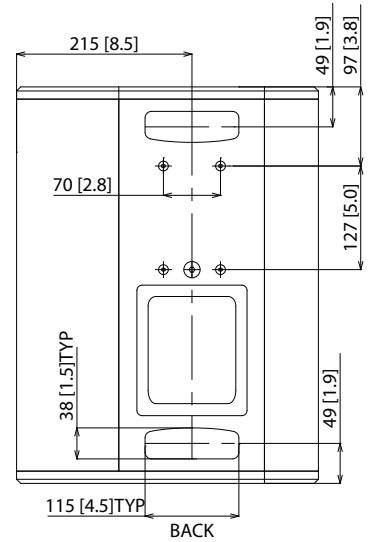
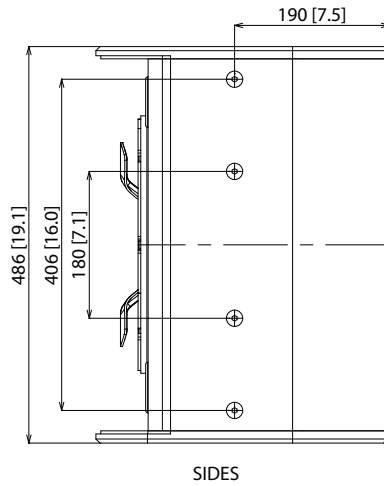
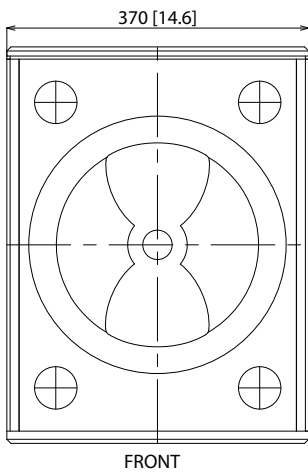
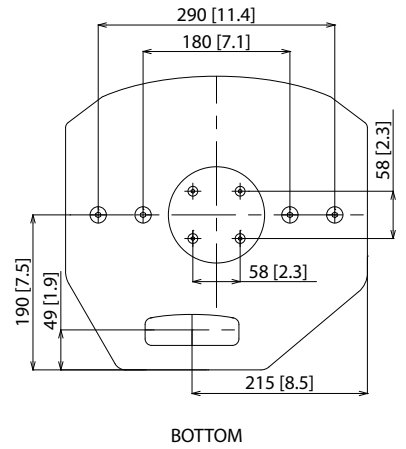
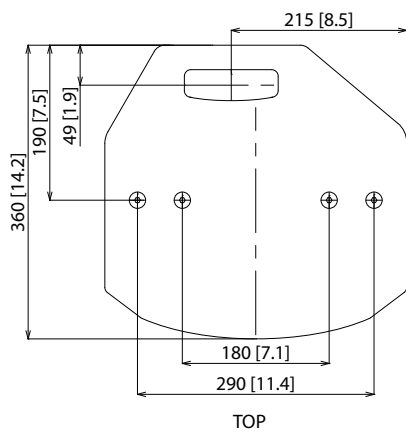

Install Speakers

VX 12Q

12" PowerDual Full Range Loudspeaker
with Q-Centric Waveguide for Portable and
Installation Applications

Technical Specifications

System

Frequency response	80 Hz - 25 kHz \pm 3 dB 60 Hz - 30 kHz -10 dB
Nominal dispersion	75° H x 40° V @ -6 dB points
Directivity factor (Q)	13
Directivity index (DI)	11.1
Power handling (IEC)	
Passive	350 W continuous, 1,400 W peak
Bi-amp	LF: 350 W continuous, 1,400 W peak HF: 80 W continuous, 320 W peak
Sensitivity	97 dB (1 W @ 1 m)
Maximum SPL	
Passive	123 dB continuous, 129 dB peak
Bi-amp	LF: 124 dB continuous, 130 dB peak HF: 127 dB continuous, 132 dB peak
Impedance	
Passive	8 Ω
Bi-amp	8 Ω 8 Ω
Crossover Type	Passive / Bi-amp switchable
Components	1 x 12" (305 mm) constant directivity PowerDual with Q-Centric waveguide

Enclosure

Connectors	2x Neutrik speakON* NL4 1 x barrier strip terminals
Wiring	
Passive	Pins 1+ / 1- Input, Pins 2+ / 2- Link
Bi-Amp	Pins 1+ / 1- LF, Pins 2+ / 2- HF
Dimensions H x W x D	487 x 371 x 361 mm (19.2 x 14.6 x 14.2")
Net weight	20kg (44.0 lbs)
Construction	15 mm (5/8") enclosure / 18 mm (3/4") front, plywood, vented and internally braced
Finish	Semi matt black paint (white optional)
Grille	Powder coated perforated steel
Flying hardware	M10 x 8 flying inserts (portrait or landscape mounting)
	M10 x 8 yoke bracket inserts
	2 x Intergrid carrying handles
	Blanking plate for optional VTH pole mount
	Compatible with industry standard brackets
	M6 x 4 inserts

Accessories

Yoke Horizontal VX12
Yoke Horizontal VX12 - WH
Yoke Vertical VX12/VX12.2
Yoke Vertical VX12/VX12.2 - WH
VTH Top Hat

Install Speakers

VX 12Q

12" PowerDual Full Range Loudspeaker
with Q-Centric Waveguide for Portable and
Installation Applications

Architecture & Engineering Specifications

The loudspeaker shall consist of a 305 mm (12") full range, single point source PowerDual transducer with Q-Centric waveguide. The low and the high frequency elements shall be combined by an internal passive crossover network operating at 1.5 kHz. A user configurable internal switching arrangement on the input panel shall allow selection of full range passive or bi-amped two-way powering modes.

Performance of the loudspeaker, without any external electronic control, shall meet or exceed the following criteria: Frequency response in full range mode measured at 1 metre on axis with swept sine wave shall be 80 Hz – 25 kHz (-3 dB). In passive full range mode sensitivity mode shall be at least 97 dB (anechoic) 1 watt @ 1 metre and the loudspeaker shall be capable of producing a peak output level of 129 dB (anechoic) on axis at 1 metre. Dispersion shall be 75 degrees horizontal x 40 degrees vertical (6 dB). The system shall have a nominal impedance of 8 ohms. Long-term power handling (EIA-426B) in passive full range mode shall be 350 watts and recommended amplifier power shall be 700 watts.

The enclosure shall be an optimally tuned 36.4 litre vented enclosure of plywood construction. The enclosure shall be fitted with dual integral carrying handles, blanked off recess for optional pole-mount socket installation, 8 x M10 bracket inserts for landscape or portrait mounting, and 8 x M10 mounting points for yoke bracket inserts. The enclosure shall not exceed the following dimensions: 487 x 371 x 361 mm or 19.2 x 14.6 x 14.2" (H x W x D). The loudspeaker shall be the [TANNOY VX 12Q](#).

Install Speakers

VX 12Q

12" PowerDual Full Range Loudspeaker
with Q-Centric Waveguide for Portable and
Installation Applications

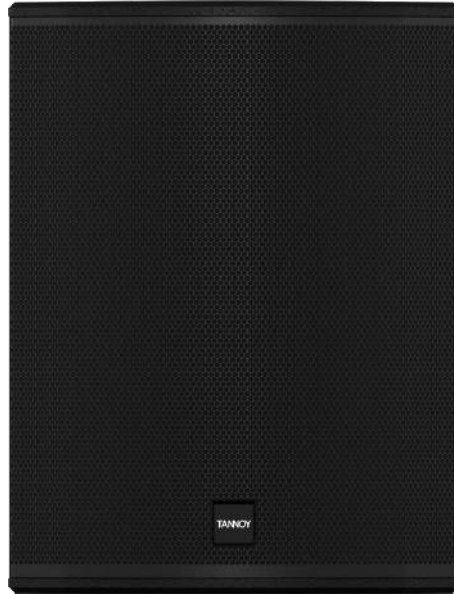

Install Speakers

VX 12Q

12" PowerDual Full Range Loudspeaker
with Q-Centric Waveguide for Portable and
Installation Applications

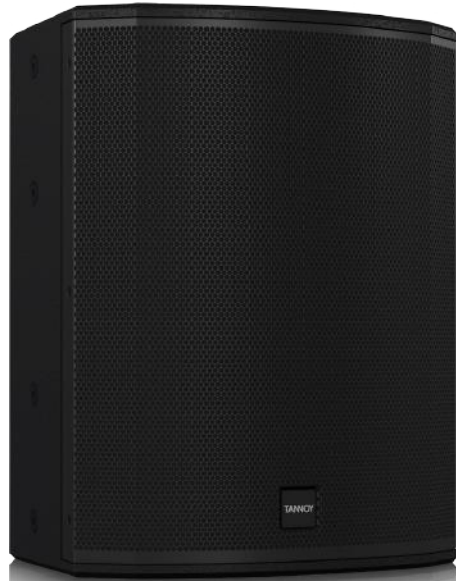

Install Speakers

VX 12Q

12" PowerDual Full Range Loudspeaker
with Q-Centric Waveguide for Portable and
Installation Applications

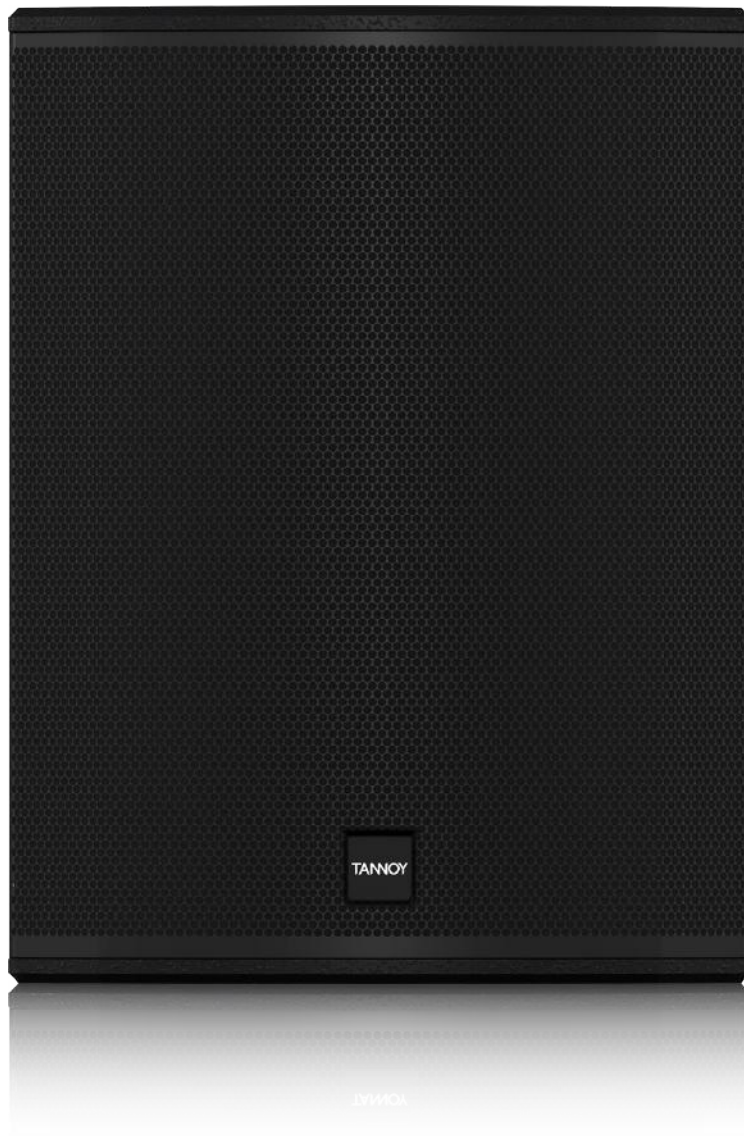

Install Speakers

VX 12Q

12" PowerDual Full Range Loudspeaker
with Q-Centric Waveguide for Portable and
Installation Applications



Install Speakers

VX 12Q

12" PowerDual Full Range Loudspeaker
with Q-Centric Waveguide for Portable and
Installation Applications



For service, support or more information contact the TANNOY location nearest you:

Europe
MUSIC Group Services UK
Tel: +44 1562 547 100
Email: CARE@music-group.com

USA/Canada
MUSIC Group Services NV Inc.
Tel: +1 702 963 1300
Email: CARE@music-group.com

Japan
MUSIC Group Services JP K.K.
Tel: +81 3 5833 9121
Email: CARE@music-group.com

MUSIC Group accepts no liability for any loss which may be suffered by any person who relies either wholly or in part upon any description, photograph, or statement contained herein. Technical specifications, appearances and other information are subject to change without notice. All trademarks are the property of their respective owners. MIDAS, KLARK TEKNIK, LAB GRUPPEN, LAKE, TANNOY, TURBOSOUND, TC ELECTRONIC, TC HELICON, BEHRINGER, BUGERA and DDA are trademarks or registered trademarks of MUSIC Group IP Ltd.
© MUSIC Group IP Ltd. 2017 All rights reserved.

TANNOY