



iNSPIRE **iP2000/iP1000/iP500**

1,000/600 Watt Powered Column Loudspeaker with a
12"/8" Subwoofer, 17/9/6 Neodymium Drivers,
KLARK TEKNIK Spatial Sound Technology, Digital Mixer,
Remote Control via iPhone/iPad and Bluetooth Audio Streaming

Quick Start Guide



EN

EN Important Safety Instructions

ES



Terminals marked with this symbol carry electrical current of sufficient magnitude to constitute risk of electric shock.

Use only high-quality professional speaker cables with ¼" TS or twist-locking plugs pre-installed. All other installation or modification should be performed only by qualified personnel.



This symbol, wherever it appears, alerts you to the presence of uninsulated dangerous voltage inside the enclosure - voltage that may be sufficient to constitute a risk of shock.



This symbol, wherever it appears, alerts you to important operating and maintenance instructions in the accompanying literature. Please read the manual.

**Caution**

To reduce the risk of electric shock, do not remove the top cover (or the rear section). No user serviceable parts inside. Refer servicing to qualified personnel.

**Caution**

To reduce the risk of fire or electric shock, do not expose this appliance to rain and moisture. The apparatus shall not be exposed to dripping or splashing liquids and no objects filled with liquids, such as vases, shall be placed on the apparatus.

**Caution**

These service instructions are for use by qualified service personnel only. To reduce the risk of electric shock do not perform any servicing other than that contained in the operation instructions. Repairs have to be performed by qualified service personnel.

1. Read these instructions.
2. Keep these instructions.
3. Heed all warnings.
4. Follow all instructions.
5. Do not use this apparatus near water.
6. Clean only with dry cloth.
7. Do not block any ventilation openings. Install in accordance with the manufacturer's instructions.
8. Do not install near any heat sources such as radiators, heat registers, stoves, or other apparatus (including amplifiers) that produce heat.

9. Do not defeat the safety purpose of the polarized or grounding-type plug. A polarized plug has two blades with one wider than the other. A grounding-type plug has two blades and a third grounding prong. The wide blade or the third prong are provided for your safety. If the provided plug does not fit into your outlet, consult an electrician for replacement of the obsolete outlet.

10. Protect the power cord from being walked on or pinched particularly at plugs, convenience receptacles, and the point where they exit from the apparatus.

11. Use only attachments/accessories specified by the manufacturer.



12. Use only with the cart, stand, tripod, bracket, or table specified by the manufacturer, or sold with the apparatus. When a cart is used, use caution when moving the cart/apparatus combination to avoid

injury from tip-over.

13. Unplug this apparatus during lightning storms or when unused for long periods of time.

14. Refer all servicing to qualified service personnel. Servicing is required when the apparatus has been damaged in any way, such as power supply cord or plug is damaged, liquid has been spilled or objects have fallen into the apparatus, the apparatus has been exposed to rain or moisture, does not operate normally, or has been dropped.

15. The apparatus shall be connected to a MAINS socket outlet with a protective earthing connection.

16. Where the MAINS plug or an appliance coupler is used as the disconnect device, the disconnect device shall remain readily operable.



17. Correct disposal of this product: This symbol indicates that this product must not be disposed of with household waste, according to the WEEE Directive (2012/19/EU) and your national law. This product should be taken

to a collection center licensed for the recycling of waste electrical and electronic equipment (EEE). The mishandling of this type of waste could have a possible negative impact on the environment and human health due to potentially hazardous substances that are generally associated with EEE. At the same time, your cooperation in the correct disposal of this product will contribute to the efficient use of natural resources. For more information about where you can take your waste equipment for recycling, please contact your local city office, or your household waste collection service.

18. Do not install in a confined space, such as a book case or similar unit.

19. Do not place naked flame sources, such as lighted candles, on the apparatus.

20. Please keep the environmental aspects of battery disposal in mind. Batteries must be disposed-of at a battery collection point.

21. Use this apparatus in tropical and/or moderate climates.

LEGAL DISCLAIMER

MUSIC Group accepts no liability for any loss which may be suffered by any person who relies either wholly or in part upon any description, photograph, or statement contained herein. Technical specifications, appearances and other information are subject to change without notice. All trademarks are the property of their respective owners. MIDAS, KLARK TEKNIK, LAB GRUPPEN, LAKE, TANNOY, TURBOSOUND, TC ELECTRONIC, TC HELICON, BEHRINGER, BUGERA and DDA are trademarks or registered trademarks of MUSIC Group IP Ltd. © MUSIC Group IP Ltd. 2016 All rights reserved.

LIMITED WARRANTY

For the applicable warranty terms and conditions and additional information regarding MUSIC Group's Limited Warranty, please see complete details online at music-group.com/warranty.

Thank you for choosing a TURBOSOUND loudspeaker product for your application. If you would like further information about this or any other TURBOSOUND product, please visit our website at turbosound.com.

Unpacking the Loudspeaker

After unpacking the unit please check carefully for damage. If damage is found, please notify your supplier at once. You, the consignee, must instigate any claim. Please retain all packaging in case of future re-shipment.

iP500 ships with a protective cover for the subwoofer and a shoulder bag for the column segments. Make sure to keep these covers so you can protect your iP500 from unnecessary wear and tear!

For iP1000 and iP2000, covers and shoulder bags are available separately.

Assembly

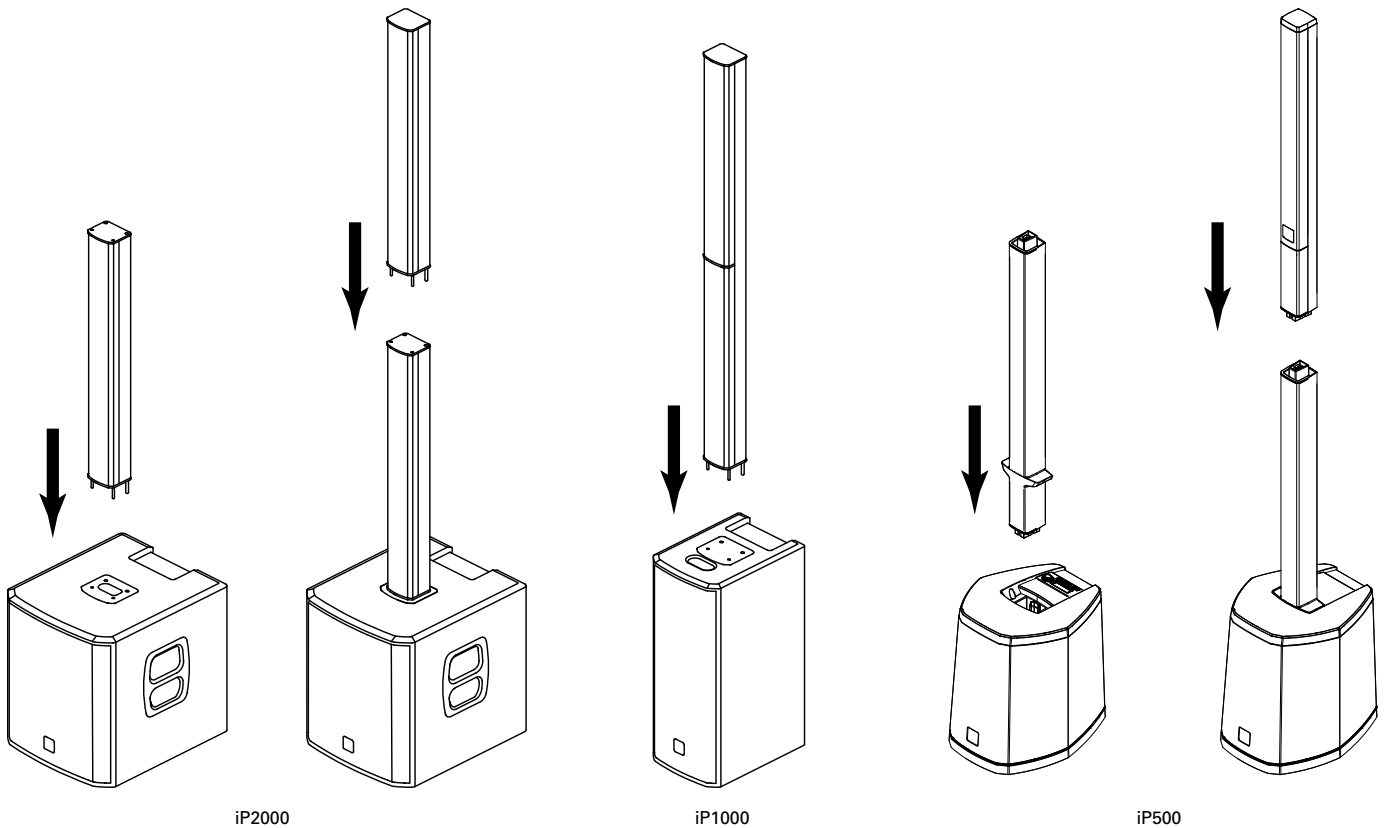

iP500, iP1000 and iP2000 speakers ship with separate base and column elements that will need to be assembled.

To assemble the speakers, follow these steps:

1. Make sure the unit is switched off.
2. Place the base unit onto a firm, level surface, with the column connection inputs facing upward.
3. Align the speaker column over the base unit's connection inputs with the column connectors facing downward.
4. Lower the speaker column into the connection input and gently press downward until the column connectors slot into place.

Note: iP2000 and iP500 feature a 2-piece column assembly. Connect the lower column assembly to the base unit first, and then connect the upper column segment directly on top of the lower segment.





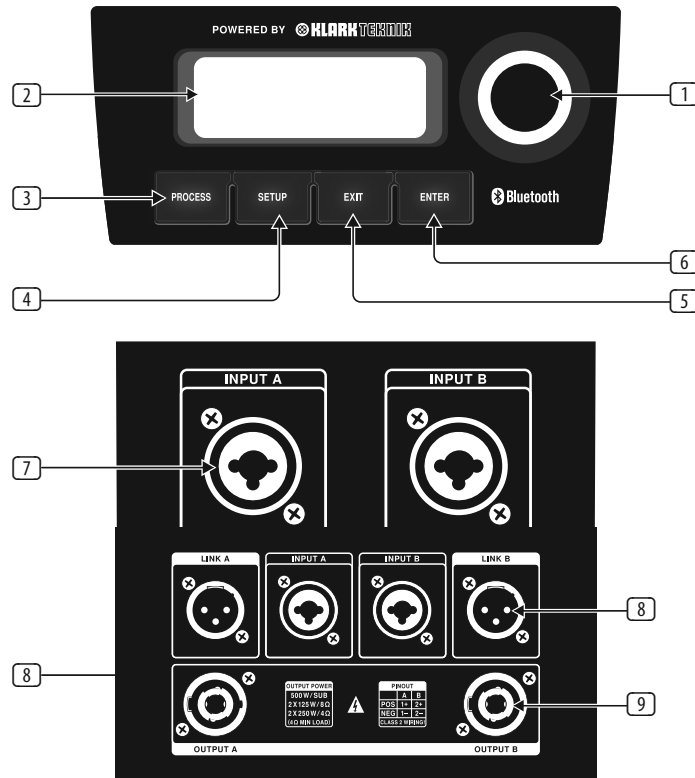



Once the column assembly is firmly slotted into place, the iP speakers will automatically make all power and audio connections between the base unit and the speaker column.

EN Controls

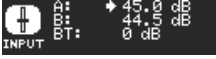
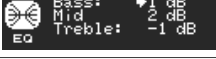

- 1 **ENCODER KNOB** toggles between Graphic and Edit modes (when pressed) and changes parameter values (when rotated).
- 2 **LCD SCREEN** displays the current DSP module and parameter settings.
- 3 **PROCESS** button accesses the DSP signal processing menu.
- 4 **SETUP** accesses the setup features menu.
- 5 **EXIT** button saves changes and returns to the previous menu screen.
- 6 **ENTER** button selects sub-menu or confirms parameter changes.
- 7 **INPUT A/INPUT B** combo jacks accept input signals using XLR, balanced ¼" TRS or unbalanced ¼" TS connectors.
- 8 **LINK A/LINK B XLR** connectors provide un-processed copies of the INPUT A or INPUT B signals.

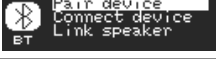
iP DSP Menu Structure

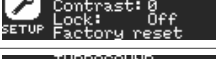
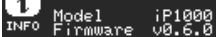
Menu	Sub-Menu	Fullrange	Function
		Main Screen	<p>Displays level indicators and model name.</p> <p>Displays the following Bluetooth* status information:</p> <ul style="list-style-type: none"> Bluetooth symbol indicates connection to audio and remote control device (iPhone*, etc.). "M" or "S" below the Bluetooth symbol indicate that the speaker is linked to another iP speaker as MASTER (left channel, "M") or SLAVE (right channel, "S"). <p>Rotate the encoder knob to adjust the output volume.</p> <p>Press the encoder knob enter the last used sub-menu.</p> <p>Press the Process and Setup buttons to access sub-menus.</p>
		Volume	Rotate the encoder to change the output volume.
		MODE	Selects from 4 preset equalisations, depending on function and music type.
		INPUT	Sets input mixer gain for analogue input A and B, as well as Bluetooth.
		EQ (Equalisation)	Allows adjustment of three band equaliser control, bass, midrange and treble.
		POSIT. (Position)	Selects DSP compensation depending on the speaker position: corner, wall or floor.
		BT (Bluetooth)	Lets you pair the speaker with mobile Bluetooth devices and link to another iP speaker as master / slave.
		SUBWOOFER	Allows control of subwoofer relative level.
		SETUP	Sets LCD back panel contrast, device lock and factory reset.
		INFO	Displays model and firmware information.

*iPhone is a trademark of Apple Inc. The Bluetooth word mark and logos are registered trademarks owned by Bluetooth SIG, Inc. and any use of such marks is under license.

iP Series Analogue Connection

Despite their sophistication, iP speakers offer straightforward analogue connectivity, and you can easily arrange the iP system to allow simple control of levels from other devices, such as mixers. You can also daisy-chain multiple iP speakers using only the analogue connections, and then directly control the overall level from your mixer's master fader.

For example, you have four iP speakers and a mixer with simple left-right stereo outputs. For typical operation, set the DSP volume and input gain settings on all speakers to a flat "0 dB" setting. Connect the mixer's left and right stereo outputs to the first two speakers' analogue INPUT A connections (the left and right mixer outputs will go to separate speakers). Then, run cables from the OUTPUT analogue connections to the remaining two speakers. In a similar way, subwoofers can also be linked to the analogue OUTPUT.

EN iP Series Bluetooth Instructions

Bluetooth Connection

To play audio from a Bluetooth-enabled device, you will need at least one iP speaker and an iPad*/iPhone/Android*/Windows* device with basic Bluetooth connectivity. With a basic Bluetooth connection, all related iP DSP functions must still be controlled directly from the iP rear panel via the rotary encoder.

For Apple* iOS devices, you can also download a dedicated TURBOSOUND iP Bluetooth app from the App Store. This iP Bluetooth app allows you to control a single or stereo pair of iP speakers, including all DSP functions, remotely from your iOS device (see "Bluetooth Control" below for more information).

Bluetooth Streaming

To stream Bluetooth audio with any Bluetooth device (iPad/iPhone/Android/Windows, etc.)

Mono operation

1. Enable Bluetooth on your remote device.
2. Switch on your iP speaker and minimize the volume.
3. Select "Pair device" from the iP speaker's Bluetooth menu.



4. Check that your remote device is searching for a connection.
5. Once your device detects the iP speaker, select the iP speaker from your remote device's menu (e.g., "TURBOSOUND iP2000").
6. Wait until the remote device shows an active connection, and then check the speaker's Bluetooth menu, which should display the name of the remote device (e.g., "HUAWEI P7-L07").

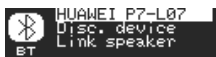

7. Bluetooth music can now be streamed to your iP speaker. The stereo signal will automatically mix down to mono.
8. The iP speaker will display the Bluetooth indicator on the main, top-level DSP screen.



Stereo operation

1. Complete the steps above to connect the first speaker to Bluetooth audio.
2. The first connected speaker automatically becomes the MASTER speaker.
3. Switch on the second speaker, which becomes the SLAVE speaker.
4. Select "Link speaker" from the SLAVE speaker's Bluetooth menu.



5. The SLAVE speaker will display "Slave linking..."
6. Select "Link speaker" from the MASTER speaker's Bluetooth menu.
7. The MASTER speaker will display "Master Linking..."
8. WAIT for the speakers to link.
9. Once the linking process is complete, Bluetooth audio will stream to the two speakers. The MASTER speaker will receive the left channel, and the SLAVE speaker will receive the right channel.
10. MASTER and SLAVE connection will be indicated on the main, top-level DSP screens.



Bluetooth Control

A dedicated iOS control app for TURBOSOUND Bluetooth speakers can be downloaded from the App Store.

- In both mono and stereo mode, first pair the MASTER speaker, and then launch the iOS control app.
- The iOS control app will automatically detect and adapt for mono or stereo mode.
- To alter the speaker settings, swipe the screen or press the settings icon. All iP speaker settings can be accessed from the iOS control app.

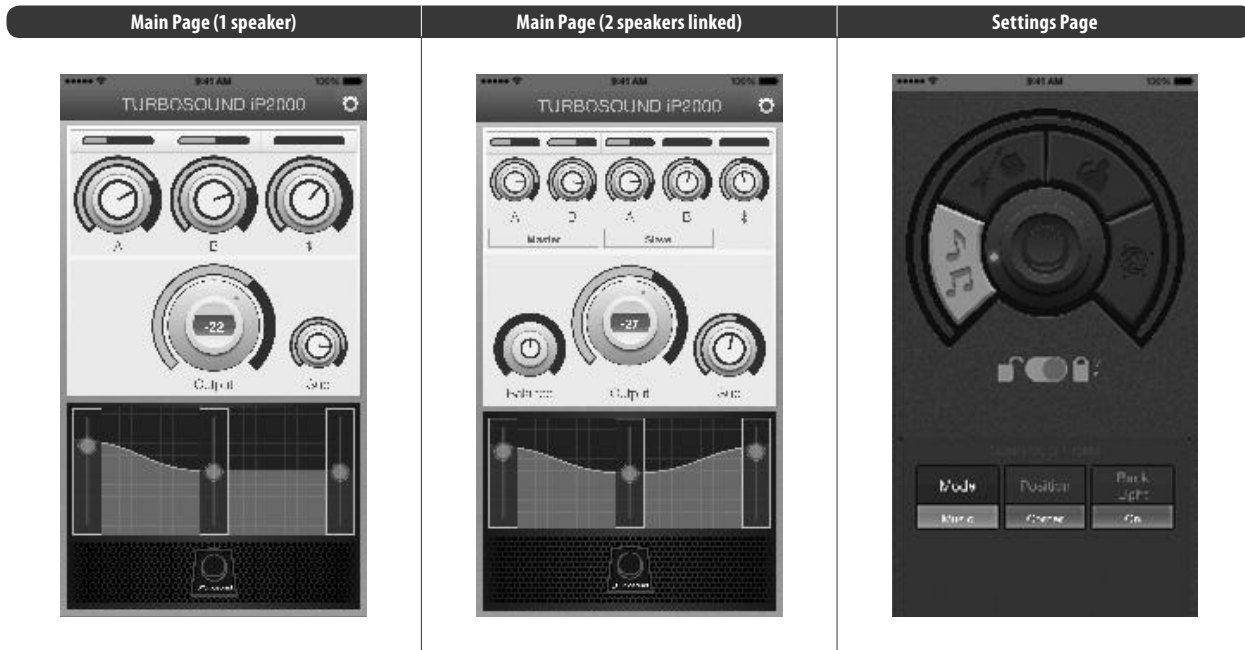

IMPORTANT NOTE: The mounting of a permanently installed sound system may be dangerous unless undertaken by qualified personnel with the required experience and certification to perform the necessary tasks. Walls, floors or ceilings must be capable of safely and securely supporting the actual load. The mounting accessory used must be safely and securely fixed both to the loudspeaker and to the wall, floor or ceiling.

When mounting rigging components on walls, floors or ceilings, ensure that all fixings and fasteners used are of an appropriate size and load rating. Wall and ceiling claddings, and the construction and composition of walls and ceilings, all need to be taken into account when determining whether a particular fixing arrangement can be safely employed for a particular load. Cavity plugs or other specialist fixings, if required, must be of an appropriate type, and must be fitted and used in accordance with the maker's instructions.

The operation of your speaker cabinet as part of a flown system, if installed incorrectly and improperly, can potentially expose persons to serious health risks and even death. In addition, please ensure that electrical, mechanical and acoustic considerations are discussed with qualified and certified (by local state or national authorities) personnel prior to any installation or flying.

Make sure that speaker cabinets are set up and flown by qualified and certified personnel only, using dedicated equipment and original parts and components delivered with the unit. If any parts or components are missing please contact your Dealer before attempting to set up the system.

Be sure to observe the local, state and other safety regulations applicable in your country. MUSIC Group, including the MUSIC Group companies listed on the enclosed "Service Information Sheet", assumes no liability for any damage or personal injury resulting from improper use, installation or operation of the product. Regular checks must be conducted by qualified personnel to ensure that the system remains in a secure and stable condition. Make sure that, where the speaker is flown, the area underneath the speaker is free of human traffic. Do not fly the speaker in areas that can be entered or used by members of the public.

Speakers create a magnetic field, even if not in operation. Therefore, please keep all materials that can be affected by such fields (discs, computers, monitors, etc) at a safe distance. A safe distance is usually between 1 and 2 metres.

EN Technical Specifications

	iP2000	iP1000	iP500
System			
Frequency response	45 Hz – 20 kHz \pm 3 dB 38 Hz – 20 kHz -10 dB	50 Hz – 20 kHz \pm 3 dB 43 Hz – 20 kHz -10 dB	65 Hz – 14 kHz \pm 3 dB 50 Hz – 16 kHz -10 dB
Nominal dispersion	120° H @ -6 dB points	120° H @ -6 dB points	100° H @ -6 dB points
Maximum SPL	123 dB	122 dB	118 dB
Crossover type	4 way, active and passive	4 way, active and passive	2 way, active
Transducers	1 x 12" (305 mm) LF driver 16 x 2.75" (70 mm) MF drivers 1 x 1" (25 mm) HF compression driver	2 x 8" (208 mm) LF drivers 8 x 2.75" (70 mm) MF drivers 1 x 1" (25 mm) HF compression driver	1 x 8" (208 mm) LF driver 6 x 2" (54.2 mm) HF drivers
Limiter	Independent HF, LF	Independent HF, LF	Independent HF, LF
Amplifier			
Maximum output power*	1000 W	1000 W	600 W
Type	Class-D	Class-D	LF: Class-D HF: Class AB
Protection	Short circuit, open circuit, thermal	Short circuit, open circuit, thermal	Short circuit, open circuit, thermal
Amplifier channels	3	3	2
Connectors			
Input A / B	2 x combo jack / XLR	2 x combo jack / XLR	2 x combo jack / XLR
Sensitivity	4 dBu, nominal	4 dBu, nominal	4 dBu
Input impedance	16 k Ω unbalanced, 33 k Ω balanced	16 k Ω unbalanced, 33 k Ω balanced	16 k Ω unbalanced, 33 k Ω balanced
Maximum input level	+22 dBu	+22 dBu	+22 dBu
Link output	XLR	XLR	XLR
Mains supply	IEC mains connector with integrated power switch†	IEC mains connector with integrated power switch†	IEC mains connector with integrated power switch†
Controls			
Hardware	Rotary push-encoder	Rotary push-encoder	Rotary push-encoder
Software	iOS interface via Bluetooth	iOS interface via Bluetooth	iOS interface via Bluetooth
User DSP Functions			
Factory EQ presets	Positioning, sound mode	Positioning, sound mode	Positioning, sound mode
Display	LCD 128 x 32, blue, backlit	LCD 128 x 32, blue, backlit	LCD 128 x 32, blue, backlit
Equalisation	Bass, middle and treble	Bass, middle and treble	Bass, middle and treble
Protection	Lock-out function for all settings	Lock-out function for all settings	Lock-out function for all settings
Bluetooth Wireless Technology			
Frequency range	2402 MHz ~ 2480 MHz	2402 MHz ~ 2480 MHz	2402 MHz ~ 2480 MHz
Channel number	79	79	79
Version	Bluetooth 4.0 dual mode	Bluetooth 4.0 dual mode	Bluetooth 4.0 dual mode
Output	8 dBm	8 dBm	8 dBm
Compatibility	Supports A2DP 1.2 profile	Supports A2DP 1.2 profile	Supports A2DP 1.2 profile
Maximum communication range	30 m (without interference)	30 m (without interference)	30 m (without interference)
Connectivity	Master-slave: stereo pairing link	Master-slave: stereo pairing link	Master-slave: stereo pairing link

	iP2000	iP1000	iP500
Power Supply			
Power consumption	110 W @ ½ max power	110 W @ ½ max power	80 W @ ½ max power
Voltage (fuses)			
USA / Canada / Japan	100-120 V~, 50/60 Hz (T 6.3 A H 250 V)	100-120 V~, 50/60 Hz (T 6.3 A H 250 V)	100-120 V~, 50/60 Hz (T 6.3 A H 250 V)
UK / Australia / Europe	220-240 V~, 50/60 Hz (T 3.15 A H 250 V)	220-240 V~, 50/60 Hz (T 3.15 A H 250 V)	220-240 V~, 50/60 Hz (T 3.15 A H 250 V)
Korea / China	220-240 V~, 50/60 Hz (T 3.15 A H 250 V)	220-240 V~, 50/60 Hz (T 3.15 A H 250 V)	220-240 V~, 50/60 Hz (T 3.15 A H 250 V)
Enclosure			
Dimensions (H x W x D)	2063 x 420 x 500 mm (81.2 x 16.5 x 19.7")	1955 x 262 x 370 mm (77.0 x 10.3 x 14.6")	2006 x 321 x 400 mm (79.0 x 12.6 x 15.7")
Base	485 x 420 x 500 mm (19.1 x 16.5 x 19.7")	655 x 262 x 370 mm (25.8 x 10.3 x 14.6")	416 x 321 x 400 mm (16.4 x 12.6 x 15.7")
Tower	834 x 103 x 89 mm (32.8 x 4.0 x 3.5")	1345 x 103 x 89 mm (53.0 x 4.0 x 3.5")	918 x 132 x 72 mm (36.1 x 5.2 x 2.8")
Net weight	30.9 kg (68.1 lbs)	24.8 kg (54.7 lbs)	15.1 kg (33.2 lbs)
Construction, base	15 mm (½") birch plywood	15 mm (½") birch plywood	Engineering plastic (GXPP)
Construction, tower	Aluminium alloy	Aluminium alloy	Engineering plastic (ABS)
Finish	Semi matt black paint	Semi matt black paint	Semi matt black paint
Grille	Powder coated perforated steel	Powder coated perforated steel	Powder coated perforated steel
Accessories			
	–	–	Protective cover (included)

*independent of limiters and driver protection circuits

†Only qualified personnel are allowed to modify the AC-Main cord and to adhere to all applicable national standards.

Other important information

EN Important information

- 1. Register online.** Please register your new MUSIC Group equipment right after you purchase it by visiting turbosound.com. Registering your purchase using our simple online form helps us to process your repair claims more quickly and efficiently. Also, read the terms and conditions of our warranty, if applicable.
- 2. Malfunction.** Should your MUSIC Group Authorized Reseller not be located in your vicinity, you may contact the MUSIC Group Authorized Fulfiller for your country listed under "Support" at turbosound.com. Should your country not be listed, please check if your problem can be dealt with by our "Online Support" which may also be found under "Support" at turbosound.com. Alternatively, please submit an online warranty claim at turbosound.com BEFORE returning the product.
- 3. Power Connections.** Before plugging the unit into a power socket, please make sure you are using the correct mains voltage for your particular model. Faulty fuses must be replaced with fuses of the same type and rating without exception.

FEDERAL COMMUNICATIONS COMMISSION COMPLIANCE INFORMATION

TURBOSOUND

iNSPIRE iP2000/iP1000/iP500

Responsible Party Name: **MUSIC Group Services NV Inc.**
Address: **5270 Procyon Street
Las Vegas, NV 89118 USA**
Phone Number: **+1 702 800 8290**

iNSPIRE iP2000/iP1000/iP500

This equipment has been tested and found to comply with the limits for a Class A digital device, pursuant to part 15 of the FCC Rules. These limits are designed to provide reasonable protection against harmful interference when the equipment is operated in a commercial environment. This equipment generates, uses, and can radiate radio frequency energy and, if not installed and used in accordance with the instruction manual, may cause harmful interference to radio communications. Operation of this equipment in a residential area is likely to cause harmful interference in which case the user will be required to correct the interference at his own expense. This transmitter must not be co-located or operating in conjunction with any other antenna or transmitter.

FCC Radiation Exposure Statement

This equipment complies with FCC RF radiation exposure limits set forth for an uncontrolled environment. This equipment should be installed and operated with a minimum distance of 20 centimeters between the radiator and your body.

Caution!

The manufacturer is not responsible for any radio or TV interference caused by unauthorized modifications to this equipment. Such modifications could void the user authority to operate the equipment.

This equipment complies with Part 15 of the FCC Rules. Operation is subject to the following two conditions:

- (1) This device may not cause harmful interference, and
- (2) This device must accept any interference received, including interference that may cause undesired operation.



This product complies with the requirements of Directive of 2014/53/EU.

