

TSE SERIES

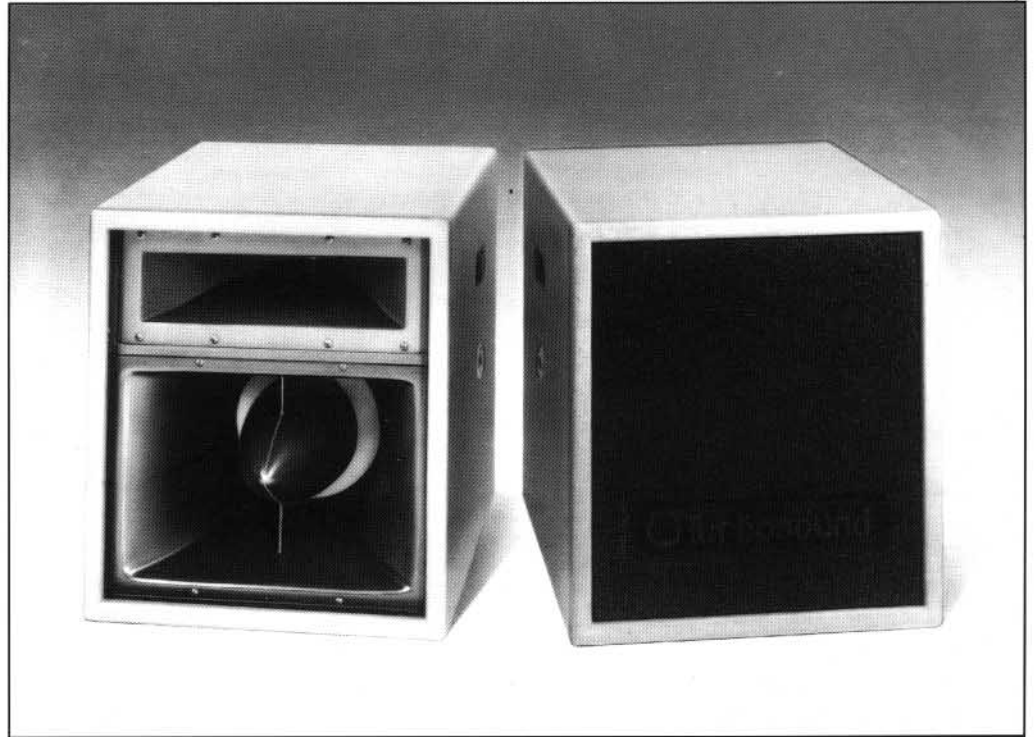

TSE-111

HIGH Q LOUDSPEAKER ENCLOSURE

The TSE-111 is a 2-way mid/high professional loudspeaker enclosure incorporating Turbosound's patented loading principles. It is a module designed to cover mid and high frequencies (250Hz - 18kHz) in primary sound reinforcement systems and is one in a series of complementary enclosures principally intended for sound contracting.

The heart of this system is the TurboMid™ device. This uses a unique design, covered worldwide by Principle Patents, which allows it to be used over four octaves (250Hz to 4kHz) - a system designer's dream.

FEATURES

- Unprecedented Transient Ability
- Precise Dispersion Control
- Seamless Midrange (250Hz-4kHz)
- Compact Enclosure Design
- Universal Flying & Mounting System

Due to the geometry of the inner workings of the device, the overall directivity is much higher than a "normal" horn of the same frontal area. The small size of the TurboMid device allows multiple units to be placed closely together so that they mutually reinforce each other at the lower end of their working range, and create an even-curved wavefront. With rising frequency, the unit becomes progressively more directional in order to minimise the problems of multi-source interference associated with arraying constant directivity horns.

This directivity control from such a small unit is a very powerful characteristic, as it allows for highly non-interactive arraying in multiple-unit systems and is imperative to achieve intelligible sound coverage in acoustically complex environments.

This enclosure is capable of outstanding electrical to acoustic power conversion (105 dB at 1W/1m) and

can develop peak sound pressure levels of 129dB. It is the result of meticulous study which compelled Turbosound to re-evaluate established design parameters. The unique developments which followed have enabled Turbosound engineers to construct a compact loudspeaker enclosure which is correctly phase and amplitude aligned without the need for compensating electronics to match or correct for component disparities.

The TSE-111 incorporates a passive third-order crossover network utilizing high-voltage polypro-

APPLICATIONS

- Sound Contracting
- Public Address Systems
- Discotheques and Clubs
- Concert Systems
- Point-source Clusters

pylene capacitors and low-loss air cored inductors. The circuit includes an externally adjustable attenuator allowing adjustment of the high-frequency output level.

A range of load-certified flying and mounting hardware is available as standard stock items. This allows simple installation and orientation of the enclosures; from a single enclosure up to a full 360° point-source cluster. (Refer to Flying and Lifting section)

The TSE Series comprises seven fully compatible modular enclosures. Each one is designed to address a specific sound reinforcement situation and to defeat the acoustic problems presented to it. The result: a dedicated system producing a natural sound from an unusually compact range of enclosures.

Please refer to the Product Range Catalogue and the individual Engineering Information sheets for further information.

TECHNICAL SPECIFICATIONS

Dimensions¹	502 mm H x 451mm W x 483mm D (19¾" H x 17¾" W x 19" D)
Weight	28 kg (62lbs)
Components	1 x 10" MF driver on a TurboMid™ device 1 x 1" HF driver on a custom flare
Frequency Response²	200 - 18,000 Hz ± 4dB (Recommended operational range 250 - 20,000 Hz)
Dispersion³	70°H x 60°V @ -6dB points
Power Handling	150W RMS (300W program)
Sensitivity⁴	105dB, 1 Watt / 1 meter (Average)
Maximum SPL	124dB (Continuous) ⁵ 129dB (Peak) ⁶
Crossover⁷	Active: Recommended point 250Hz, 24dB/octave slope, Linkwitz-Riley. Internal passive crossover: 3k7 Hz, third order high-pass only. Constant impedance tweeter attenuator adjustable from OFF to + 3dB (over system balance).
Impedance	16 ohms nominal

Polarity	Positive voltage applied to pin 2 of the XLR-3 connector causes rearward MF cone movement and rearward HF diaphragm movement.	
Construction	15mm Finnish birch ply throughout; rebated, screwed and glued. Finished in TurboBlue semi-matt paint. ⁸ Two recessed carrying handles.	
Grille	1" thick, 30 PPI fully reticulated foam	
Connectors	3 pin XLR; 1 male, 1 female Wired: pin 1 -ve ; pin 2 +ve ; pin 3 N/C	
Options	HDP-111	Heavy duty padded cover
	PA-111	Pole kit assembly
	FF-111	Flying frame
	FY-111	Flying yoke
Spares	FG-111	Replacement foam grille
	LS-1004	10" MF loudspeaker
	CD-102	1" HF compression driver
	RC-1004	Recone kit for LS-1004
	RD-102	Replacement diaphragm for CD-102
	PX-111	Internal passive crossover network
	ASC-203	Aerosol can: TurboBlue

All measurements are actual figures taken from real-time testing using stated inputs, free from any filtering or weighting. Therefore, actual figures may significantly exceed that of other manufacturers with higher published weighted ratings.

Notes

- ¹ Due to the tolerances of Finnish birch plywood, dimensions may vary by ± 3mm (1/8").
- ² Measured on axis, using swept sine-wave input, in a half-space environment.
- ³ Average over stated bandwidth.
- ⁴ Average over stated bandwidth. Measured in a half-space environment at 5 Watts/3 meters, then scaled to represent 1 Watt/1 meter using a swept sine-wave input.

- ⁵ Unweighted diode-clipped pink noise. Measured in a half-space environment at 3 meters, then scaled to represent 1 meter.
- ⁶ Verified by subjective listening tests of familiar program material, before the onset of perceived signal degradation.
- ⁷ Crossover and driver placement optimised for best phase response at crossover point. Polypropylene capacitors and air-cored inductors are used throughout.
- ⁸ Optional black.

FREQUENCY RESPONSE; SENSITIVITY & HARMONIC DISTORTION

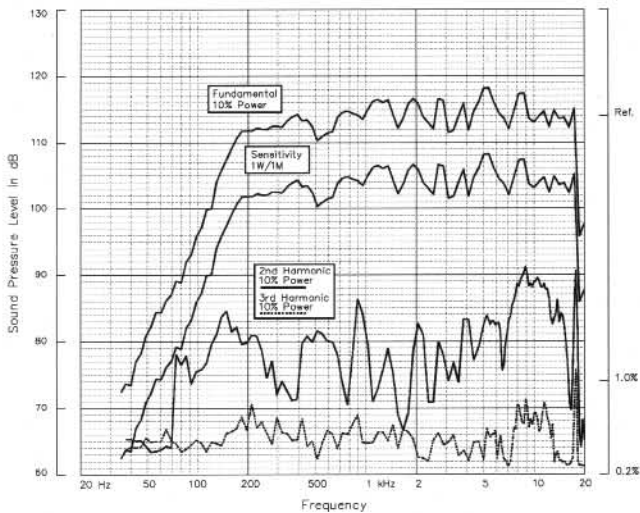

IMPEDANCE

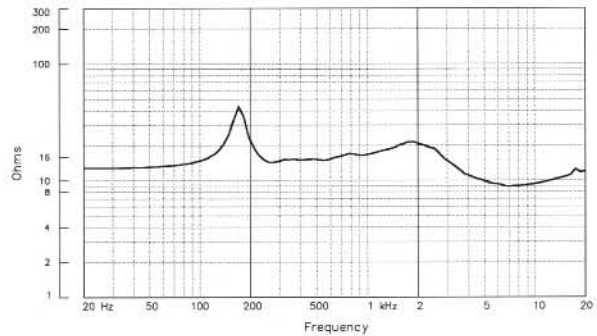

Notes on Measurement Conditions

Impedance

A common method, constant current circuit was used to measure the impedance.

Frequency Response

The frequency response shown was obtained by feeding a swept sine-wave through the system in a half-space environment. The position of the microphone was vertically on-axis, horizontally in-line with the MF/HF section at a distance of 3 meters, then scaled to represent 1 meter.

2nd & 3rd Harmonic Distortion

Distortion measurements were obtained using a Brüel & Kjær harmonic distortion analysis system and comply with AES recommendations for enclosure measurement (AES Paper reference: ANSI S4-26-1984).

Data Conversion

All graphs are digitally generated using the APEX custom software system, designed to translate data derived from Brüel & Kjær and Audio Precision "System One" test equipment into AutoCAD™. This program enables graphical information to be plotted to an accuracy of more than four decimal places.

DIRECTIVITY
ISOBARS

500 Hz
MF

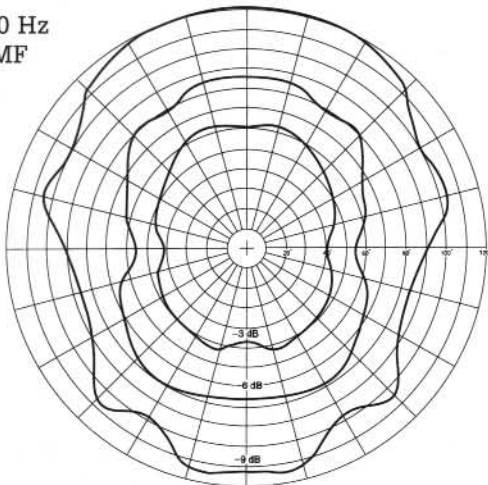

1 kHz
MF

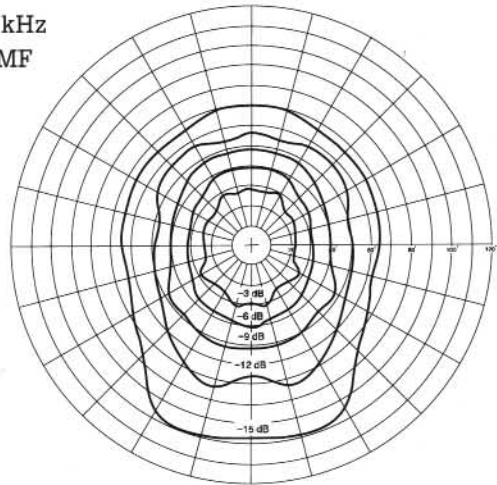

2 kHz
MF

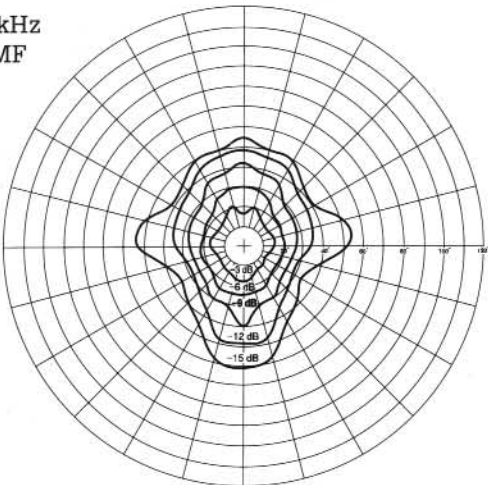

4 kHz
HF

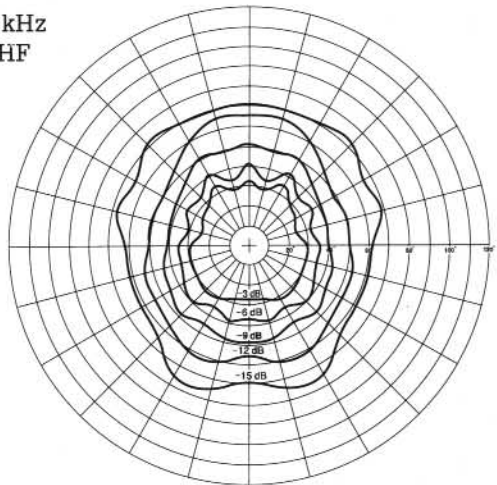

8 kHz
HF

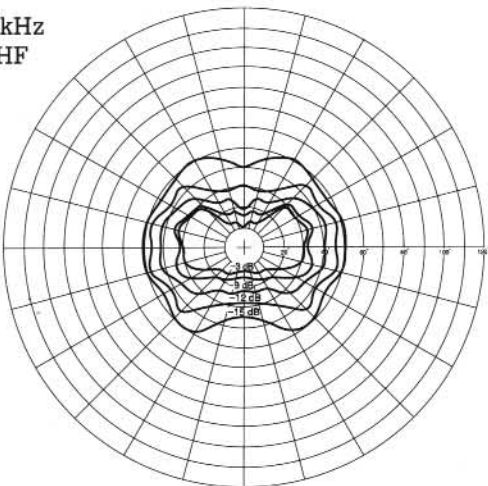

16 kHz
HF

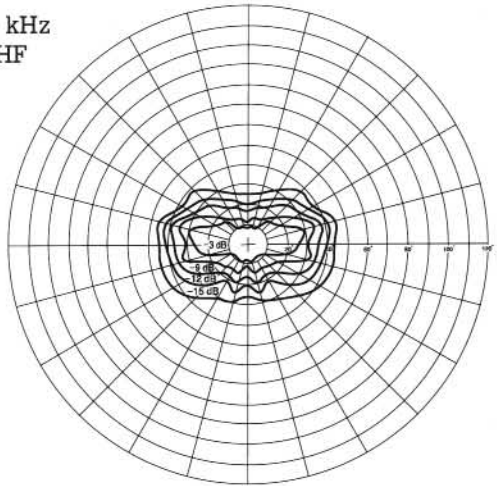

Turbosound Isobar Data

The spherical co-ordinate isobar data was computed from points taken from longitude and latitude polar measurements around the enclosure at 15° increments. Larger scale drawings are available; please consult your dealer. All isobar information was gathered by Mark Engbretson of Summit Audio Laboratories, California, USA.

DIRECTIVITY
ISOBARS

500 Hz
MF

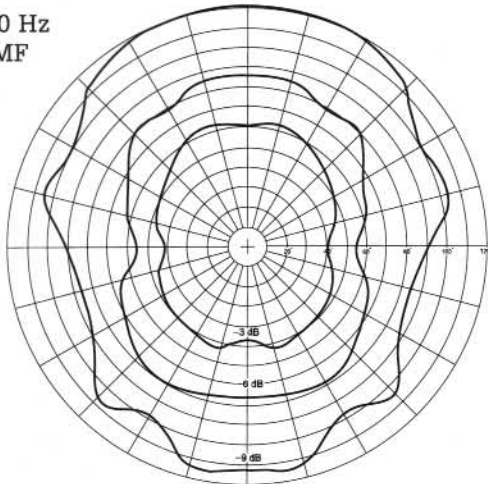

1 kHz
MF

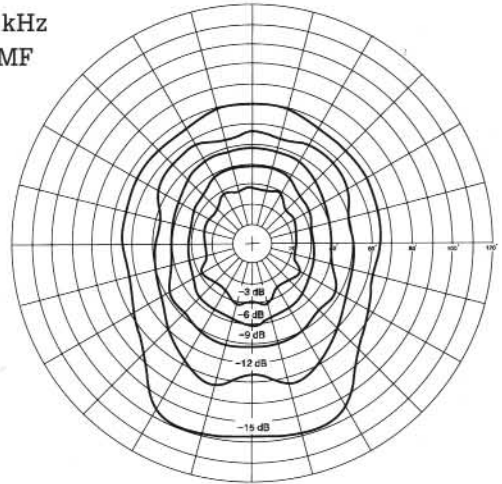

2 kHz
MF

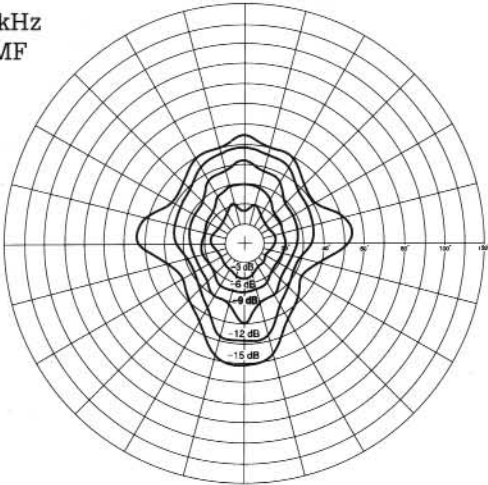

4 kHz
HF

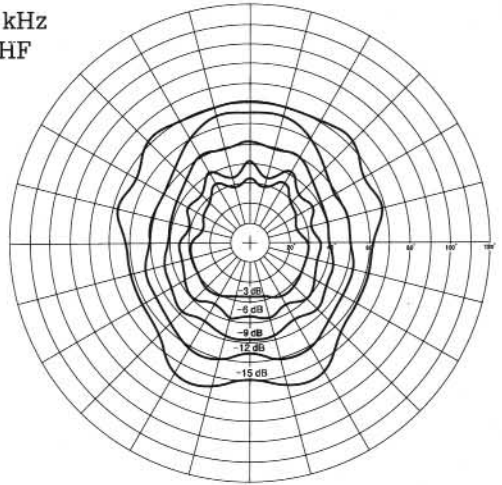

8 kHz
HF

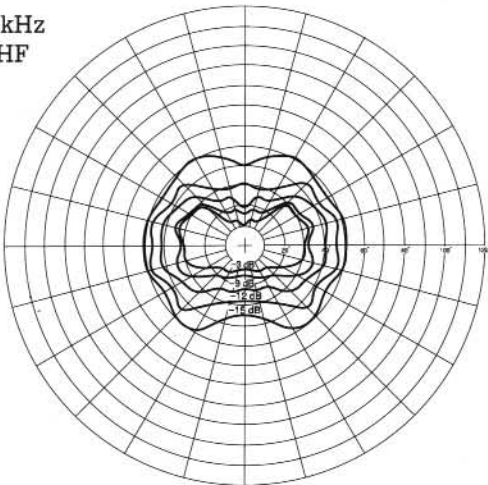

16 kHz
HF

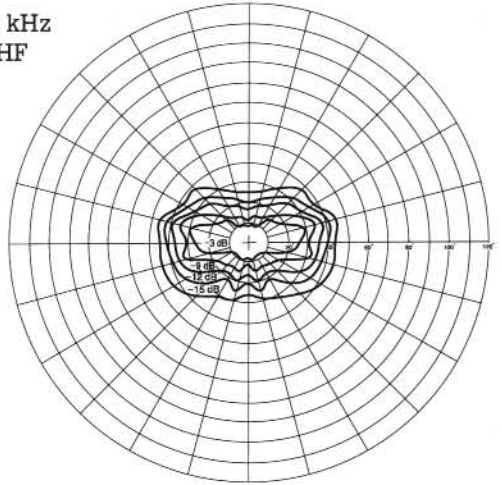

Turbosound Isobar Data

The spherical co-ordinate isobar data was computed from points taken from longitude and latitude polar measurements around the enclosure at 15° increments. Larger scale drawings are available; please consult your dealer. All isobar information was gathered by Mark Engbretson of Summit Audio Laboratories, California, USA.

A complete flying and arraying system is available for the TSE Series of enclosures. This has been designed to facilitate rapid installation and orientation. All the components are fully load-tested¹, certified and available as stock items.

A range of fixing hardware allows the TSE-111 to be installed from a variety of locations giving considerable freedom in the selection of optimum loudspeaker sites. All the components are manufactured from high-grade steel and finished with a black² powder-coat.

PA-111 Pole Kit Assembly

The PA-111 pole kit is designed to mount the TSE-111 above a TSE-118 or TSE-218 bass enclosure, raising the TSE-111 to 2 meters from ground level.

Notes

- ¹ UK Government. Individual certification available.
- ² Other colours to order.

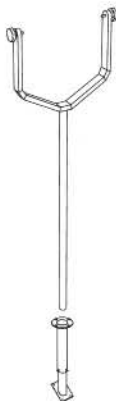

FF-111 Flying Frame

The FF-111 flying frame fits around the TSE-111 and is secured to pre-drilled and threaded points. This allows the enclosure to be suspended from wires or chains in the desired position. The FF-111 is also used when the TSE-111 is to be incorporated into arrays or clusters. (Refer to section covering clusters and arrays.)

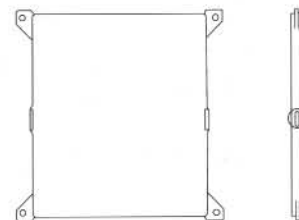

FY-111 Flying Yoke

The FY-111 flying yoke allows the TSE-111 to be fixed to lighting trusses and bars or studio gantries. The mounting spigot is manufactured to suit the majority of readily-available hanging clamps.

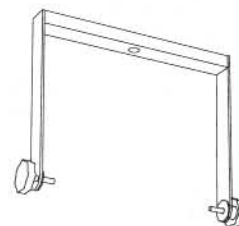

Clusters and Arrays

The system for clustering and arraying the TSE Series of enclosures is made up of a dedicated amalgam of modular flying hardware. It allows the creation of simple 90° arrays, through to complex 360° circular clusters. The hardware automatically positions the enclosures at the correct horizontal increment to correspond to their optimum dispersion characteristics and to align them at the virtual point-source. (See fig 1)

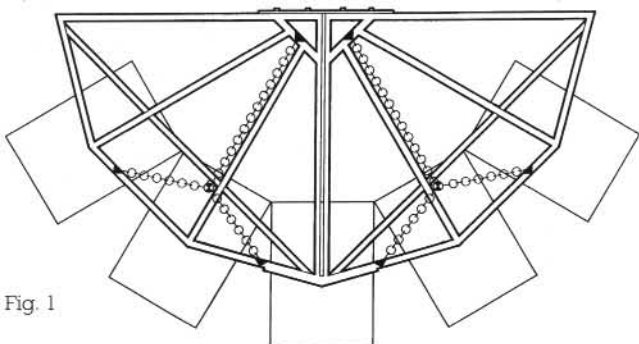

Fig. 1

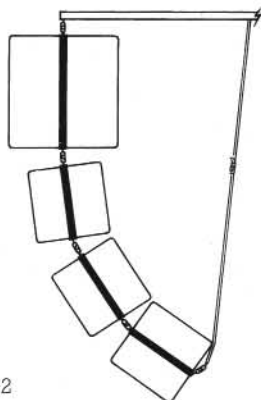

Fig. 2

Each enclosure, when fitted with a flying frame, simulates the link in a chain which forms the vertical column. The required vertical dispersion is set by adjusting a tilting strap attached between the lowest flying frame and the quadrant. One tilting strap is required for each vertical column and is available in 2 different lengths according to the amount of enclosures in each column. (See fig 2)

When TSE-118 enclosures are incorporated in the cluster, it may be desirable to lock them together. This is accomplished using the BB-118 bracing bracket which is secured using the wheel bolt holes on the rear of the enclosure.

Each array or cluster requires different quantities of hardware depending on the application. The main flying-bar is divided into 90° sections. Each will fly 3 columns of TSE enclosures. The addition of wing-plates (WP-15) increases this to 4 TSE enclosures.

Ordering Information

The FB-90C comprises the basic hardware to make up a 90°, 4 column cluster and includes the following components:

- 1 x FB-90 90° Flying quadrant (frame)
- 1 x CB-3 3-leg chain bridle used to support the flying quadrant
- 3 x HC-18 Hanging clamps to attach CB-3 to the FB-90
- 1 x SB-2 2-leg safety bridle
- 6 x EC-25 Enclosure clamps to attach flying frames
- 2 x WP-15 Wing plates
- All necessary high-tensile bolts

In addition to the FB-90C, the following components must be ordered to complete the cluster and will vary according to the particular cluster design:

- TS-6 6m Tilting strap
- TS-10 10m Tilting strap
- QL-75 Quick-links, 2 per enclosure.
- FF-111 Appropriate quantity and type of TSE flying frames, to suit cluster design.

For larger clusters (180°, 270°, and 360°) it is necessary to order multiples of the FB-90C. For example: a 270° cluster is made up from three FB-90C sets. These clusters require one additional component to lock the centres of the quadrants together. 180° clusters require a CS-180, 270° and 360° require a CS-360.

We recommend that you have your cluster and array designs verified to ensure that they are feasible and within the rated loading factors. Please contact your dealer for assistance or further information.

**ARCHITECTURAL & DESIGN
ENGINEERS SPECIFICATIONS**

The loudspeaker system shall be of the mono-amped, two-way type, consisting of one 10" mid frequency driver loaded with a patented TurboMid™ device, and one 1" high frequency unit.

Performance specifications of a typical production unit shall meet or exceed the following:

Frequency response, measured with swept sine wave input, shall be flat within ±4dB from 200 - 18,000Hz. Dispersion, at -6dB points, shall average 70°H × 60°V. Nominal impedance shall be 16 Ohms. Power handling shall be 150 watts RMS, 300 watts Program. Sensitivity measured with 1 watt input at 1 meter distance on-axis, mean-averaged over stated bandwidth, shall be 105dB. Maximum SPL (Peak), measured with music program input at stated amplifier power, shall be 129dB.

Dimensions: 502mm H × 451mm W × 483mm D
(19¾" H × 17¾" W × 19" D)

Weight: 28kg (62 lbs)

Total enclosure volume shall not exceed 0.1065 cu meters (3⅞ cu. ft.). The loudspeaker system shall be the Turbosound TSE-111. No other loudspeaker shall be acceptable unless submitted data from an independent test laboratory verify that the above combined performance/size specifications are equalled or exceeded.

A complete flying and arraying hardware system shall be available, comprising a range of load-certified components. The system shall be modular and have the facility of installing a single enclosure up to a 360° point-source array.

DIMENSIONS

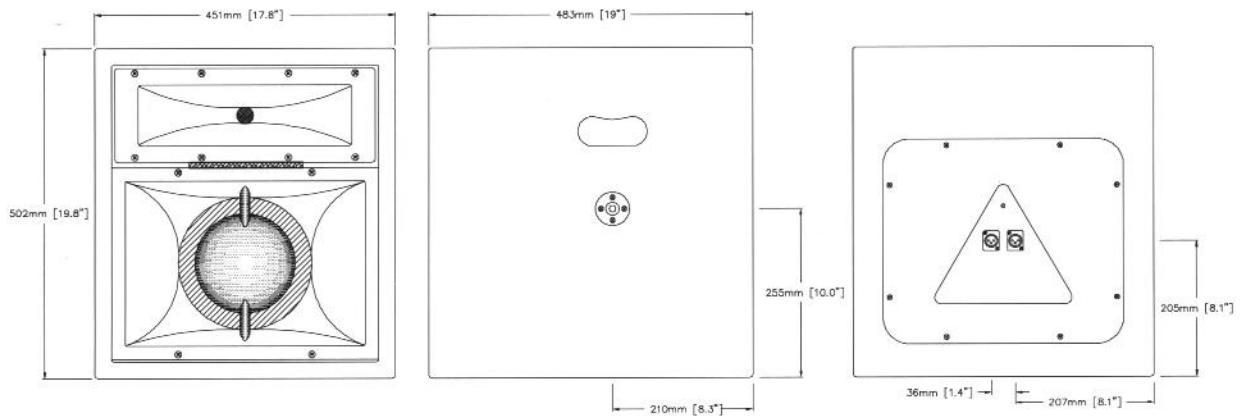

Dealer Stamp:

Turbosound operate a policy of continuous research and development. The implementation of new materials and/or production methods will always equal or exceed the published specifications which are subject to change without notice.

CAD/Microsetting by CADenza, Charlwood England.
Printed in England. © Turbosound Ltd. 1990.

TBOTE02 - (Ver 2.2)

 **Turbosound™**

Turbosound Limited
Star Road, Partridge Green
West Sussex RH13 5EZ
Telephone: (0403) 711447
Facsimile: (0403) 710155
Telex: 878723 TURBO G



TURBOSOUND PATENT INFORMATION: TurboBass™ device; TurboMid™ device; V-Series devices (V-2™); Australia 515,535; Canada 1,076,033; Japan X113424/77; U.K. 1,592,246 1,598,310 & 8,614,434; U.S.A. 4,215,761 RE32,183 & 4,882,562; West Germany P2742600/2. Worldwide patents pending on the TurboConcentric™ device. Other patents pending.

an  EdgeTech company